

NAPOLEON



VECTOR™ AND LUXURIA™ LINEAR SERIES GAS FIREPLACES  
[napoleonfireplaces.com](http://napoleonfireplaces.com)



# Vector™ and Luxuria™ Linear Gas Fireplaces. Limitless Possibilities.

Napoleon introduces the most versatile series of linear gas fireplaces, the award winning Vector™ and Luxuria™ series provides you with an elegant fire element allowing the flames radiant glow to enhance every room available as single sided or see-thru.

Napoleon's innovative Bluetooth enabled eFIRE app can be accessed from your mobile device and used to control everything on your fireplace (flame height, LED ember bed colors, blower and more).

**Napoleon's patent pending, industry leading Dynamic Heat Control™ System and Premium Glass Guard allows for installation of combustible materials up to the fireplace opening.** This heat management system eliminates the need for loud power vents, fan systems or blowers to provide better heat distribution. Take advantage of simple installation framing and easily install your televisions, sound bars or artwork above the fireplace to truly customize your home decor thanks to the drastically reduced temperatures above the fireplace.

Media Options .....	4 - 5
Vector™ Series .....	6 - 11
Luxuria™ Series .....	12 - 17
Napoleon's Dynamic Heat Control™ .....	18 - 19
Detailed Specifications & Line Drawings .....	20 - 23





The Single Sided Vector<sup>®</sup> 38 shown with Dynamic Heat Control<sup>™</sup> installed and Shore Fire and Wrought Iron Globe media.

# Media Options

Premium Birch Log Kit with Topaz Glass Embers



Beach Fire Kit



Shore Fire kit (sand included)



Mineral Rock kit



Beach Fire, Shore Fire and Mineral Rock Kits Combined



Blue Glass Embers



Amber Glass Embers



Black Glass Embers

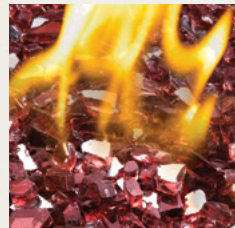

Red Glass Embers

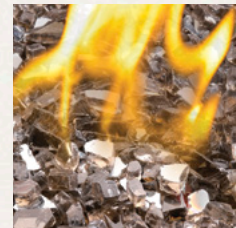

Topaz Glass Embers



Clear Glass Embers

# Media Options

Wrought Iron Globes with Shore Fire Kit



Shore Fire and Beach Fire Kits Combined



Nickel Stix with Clear Glass Beads



Birch Log Kit with Shore Fire Kit



Wrought Iron Globes with Shore Fire Kit

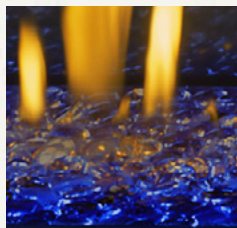

Blue Glass Beads



Amber Glass Beads

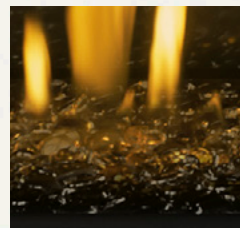

Black Glass Beads

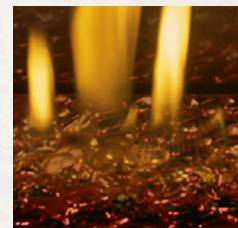

Red Glass Beads

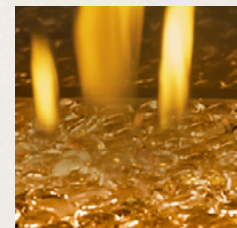

Topaz Glass Beads

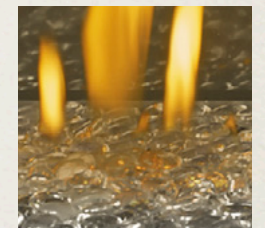

Clear Glass Beads

# Vector™ Series

## Sophisticated Fires

Napoleon's Vector™ series of linear gas fireplaces is the perfect fit for any room to make a statement in your home. Customize your fireplace with our selection of designer surrounds, choose a different surround for either side of the See-Thru Vector™ units to match or enhance your current décor. Napoleon's Vector™ Series can also be dressed to match any interior design with dozens of media options available, the possibilities are endless.

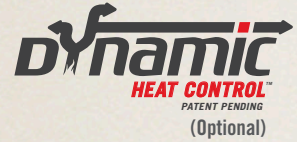

### Features



Remote Control



Choice of Glass Beads or CRYSTALINE™ Ember Bed



MIRRO-FLAME™ Porcelain Reflective Radiant Panels



eFIRE controller application available free on iTunes and Google Play store

### Mobile Device Controlled

Napoleon's eFIRE app will revolutionize the way you use your fireplace. We have cracked the code and present to you the first fireplace to be controlled by Bluetooth® technology, using an intuitive app on your mobile device.

The eFIRE application allows you to create every imaginable color, selecting the one that fits your current mood or your décor with ease. The simple color wheel tool swiftly scrolls through the full color spectrum. Napoleon's eFIRE app controls every function of your fireplace including; on/off, flame height and blower speed for total convenience.

# Style & Size Options

Various Models, Media Kits, Fronts and Trims Shown



### Black Premium Safety Barrier

Shown on Single Sided Vector™ 38 with Wrought Iron Globes on Topaz Glass Embers



### Black Premium Safety Barrier

Shown on Single Sided Vector™ 62 with Clear Glass Beads and LED Lights on



### Black Premium Safety Barrier

Shown on Single Sided Vector™ 74 with Wrought Iron Globe Kit on Topaz Glass Embers



### Classic Black Front

Shown on See-Thru Vector™ 38 with Shore and Beach Fire Kits combined



### Black Premium Safety Barrier and 1" Finishing Trim

Shown on See-Thru Vector™ 62 with Premium Birch Logs and Mineral Rock Kit on Topaz Glass Embers



### Standard Black Safety Barrier

Shown on See-Thru Vector™ 74 with Beach Fire Kit on Clear Glass Beads



### Stainless Steel Front

Shown on Single Sided Vector™ 38 with Premium Birch Logs and Shore Fire Kit



### Stainless Steel Premium Safety Barrier and 1" Finishing Trim

Shown on Single Sided Vector™ 62 with Wrought Iron Globes and Shore Fire Kit



### Standard Black Safety Barrier

Shown on See-Thru Vector™ 74 with Premium Birch Logs and Shore Fire Kit

# Vector™ 38

Single-Sided & See-Thru Models



Vector™ 38 - Black Standard Safety Barrier



Vector™ 38 - Black Premium Safety Barrier



Vector™ 38 - Stainless Steel Front



Vector™ 38 - Classic Black Front

**LV38N-1 / LV38N2-1**

Up to 30,000 BTU's

Viewing Area: 18 5/8" h x 40 3/4" w

For more detailed specifications on this unit, see pages 20-21





Vector™ 50 - Black Premium Safety Barrier



Vector™ 50 - Black Premium Safety Barrier



Vector™ 50 - Black Premium Safety Barrier and 1" Black Finishing Trim



Vector™ 50 - Stainless Steel Premium Safety Barrier and 1" Stainless Steel Finishing Trim

**LV50N-2 / LV50N2-2**

Up to 36,000 BTU's

Viewing Area: 18 5/8" h x 52 3/4" w

For more detailed specifications on this unit, see pages 20-21

# Vector™ 50

Single-Sided & See-Thru Models

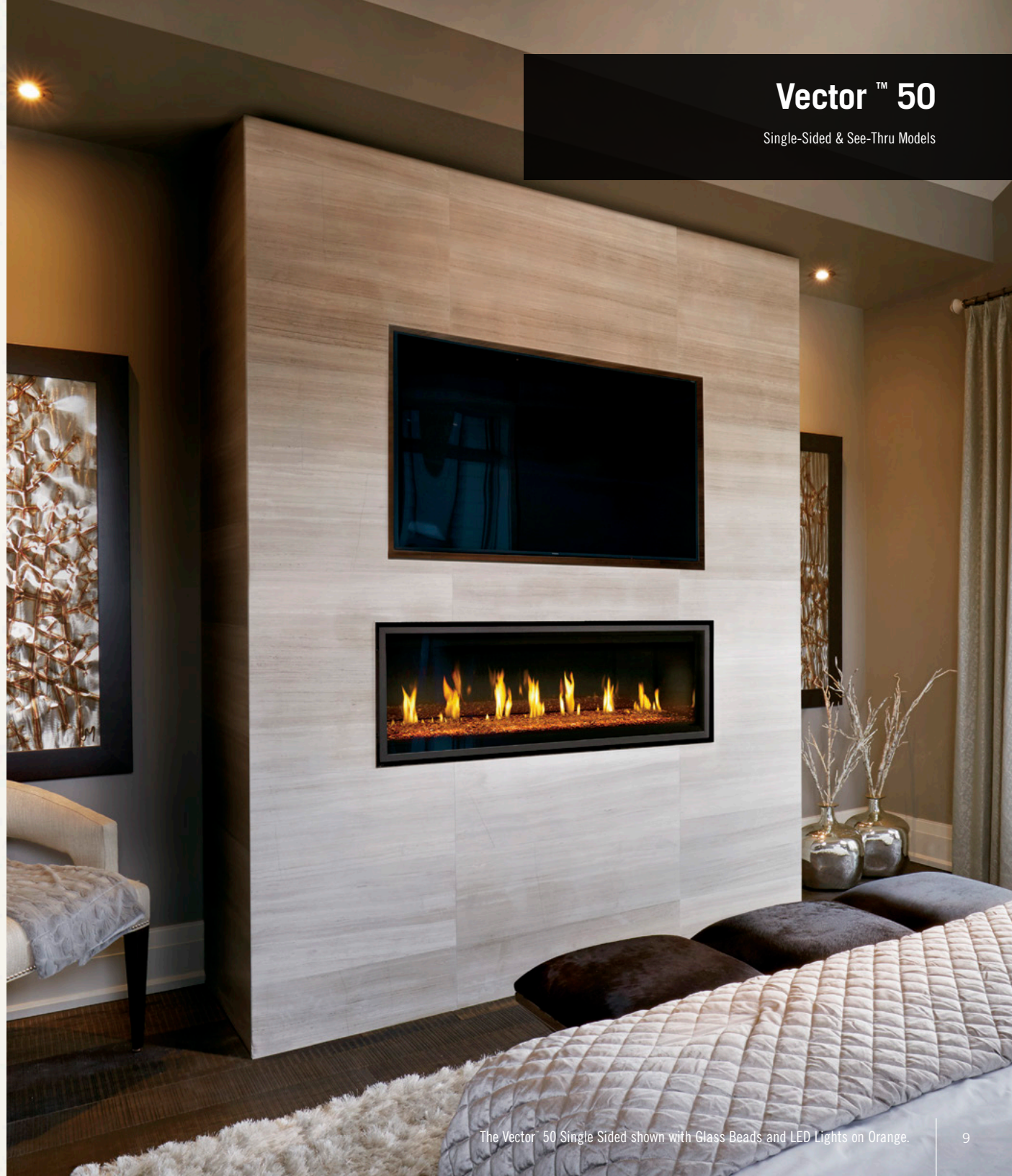

The Vector™ 50 Single Sided shown with Glass Beads and LED Lights on Orange.

# Vector™ 62

Single-Sided & See-Thru Models



Vector™ 62 - Black Premium Safety Barrier



Vector™ 62 - Black Premium Safety Barrier



Vector™ 62 - Stainless Steel Premium Safety Barrier



Vector™ 62 - Black Premium Safety Barrier and  
1" Black Finishing Trim

## LV62N / LV62N2

Up to 42,000 BTU's

Viewing Area: 18 5/8" h x 64 3/4" w

For more detailed specifications on this unit, see pages 20-21

# Vector™ 74

Single-Sided & See-Thru Models



Vector™ 74 - Black Standard Safety Barrier



See-Thru Vector™ 74 - Black Premium Safety Barrier



Vector™ 74 - Classic Black Front



See-Thru Vector™ 74 - Classic Black Front

## LV74N / LV74N2

Up to 48,000 BTU's

Viewing Area: 18 5/8" h x 76 3/4" w

For more detailed specifications on this unit, see pages 20-21

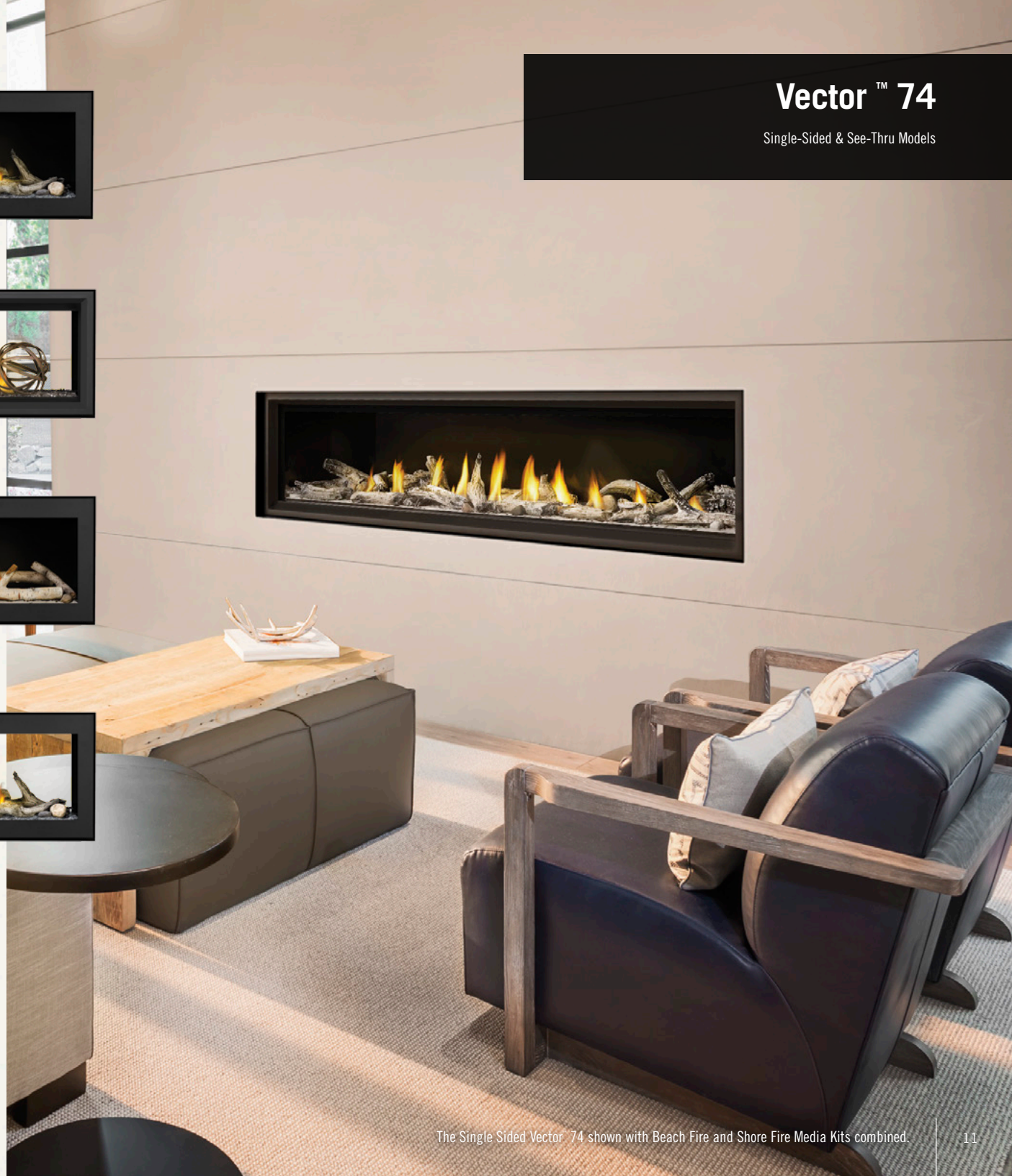

# Luxuria™ Series

Limitless Possibilities

Make a spectacular statement with Napoleon's Luxuria™ series of gas fireplaces. Thanks to our Vesta Award winning Premium Glass Guard system, there is no safety screen required, enhancing your view of the brightest flames in the series. Choose a Single Sided unit or maximize your viewing pleasure with a See-Thru model. This versatile series allows for easy installation of electronics, artwork or other heat sensitive items directly above the unit with combustible material installed flush to the opening. In combination with premium media options, the Luxuria series offers for endless installation opportunities.

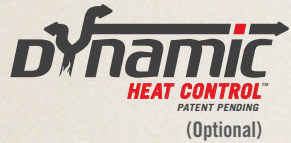

LOW ENERGY  
**LED**  
HIGH INTENSITY



## Features



Remote Control



Choice of Glass Beads or CRYSTALINE™ Ember Bed



MIRRO-FLAME™ Porcelain Reflective Radiant Panels

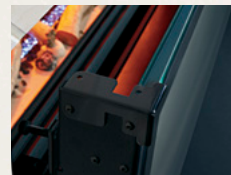

Premium Glass Guard

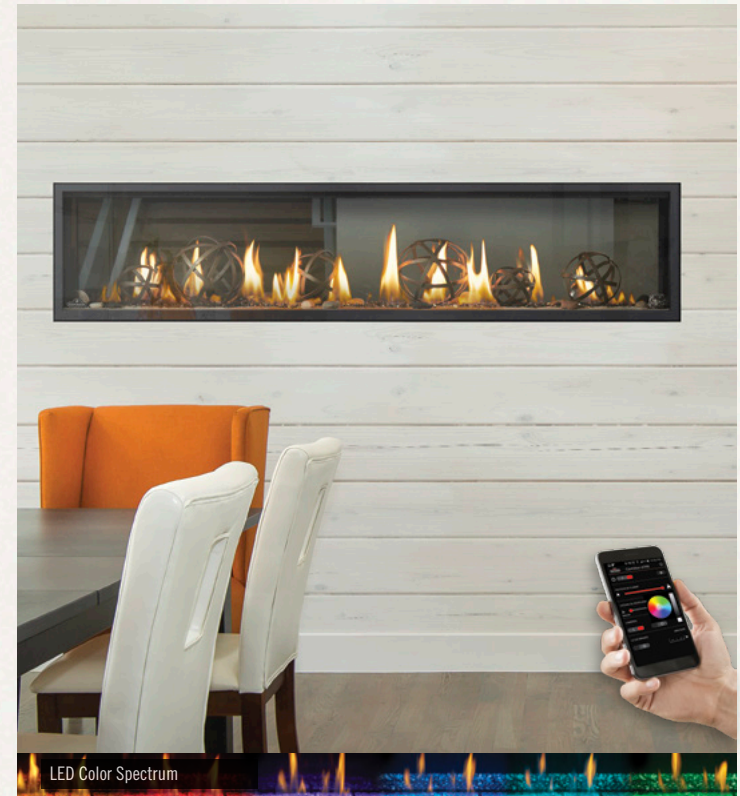

eFIRE controller application available free on iTunes and Google Play store

## Mobile Device Controlled

Napoleon's **eFIRE** app will revolutionize the way you use your fireplace. We have cracked the code and present to you the first fireplace to be controlled by *Bluetooth*® technology, using an intuitive app on your mobile device.

The **eFIRE** application allows you to create every imaginable color, selecting the one that fits your current mood, or your décor with ease, the simple color wheel tool swiftly scrolls through the full color spectrum. Napoleon's **eFIRE** app controls every function of your fireplace including; on/off, flame height and blower speed for total convenience.

# Style & Size Options

Various Models and Media Kits Shown



**Single Sided Luxuria™ 38**

Shown with Birch Logs on Shore Fire Media Kit



**See-Thru Luxuria™ 62**

Shown with Beach Fire and Shore Fire Media Kit



**Single Sided Luxuria™ 74**

Shown with Wrought Iron Globes on Shore Fire Media Kit



**See-Thru Luxuria™ 38**

Shown with Beach Fire and Shore Fire Media Kit



**Single Sided Luxuria™ 62**

Shown with Birch Logs on Shore Fire Kit



**See-Thru Luxuria™ 74**

Shown with Beach Fire and Shore Fire Media Kit



**Single Sided Luxuria™ 38**

Shown with Wrought Iron Globes on Clear Glass Beads



**See-Thru Luxuria™ 62**

Shown with Wrought Iron Globes on Glass Beads



**Single Sided Luxuria™ 74**

Shown with Birch Logs on Clear Glass Beads

# Luxuria™ 38

Single-Sided & See-Thru Models



Single Sided Luxuria™ 38



See-Thru Luxuria™ 38



Single Sided Luxuria™ 38



See-Thru Luxuria™ 38

## LVX38N / LVX38N2

Up to 32,000 BTU's

Viewing Area: 18 5/8" h x 42 1/8" w

For more detailed specifications on this unit, see pages 22-23



See-Thru Luxuria™ 50



Single Sided Luxuria™ 50



See-Thru Luxuria™ 50



Single Sided Luxuria™ 50

**LVX50N / LVX50N2**

Up to 38,000 BTU's

Viewing Area: 18 5/8" h x 54 1/8" w

For more detailed specifications on this unit, see pages 22-23

**Luxuria™ 50**

Single-Sided & See-Thru Models

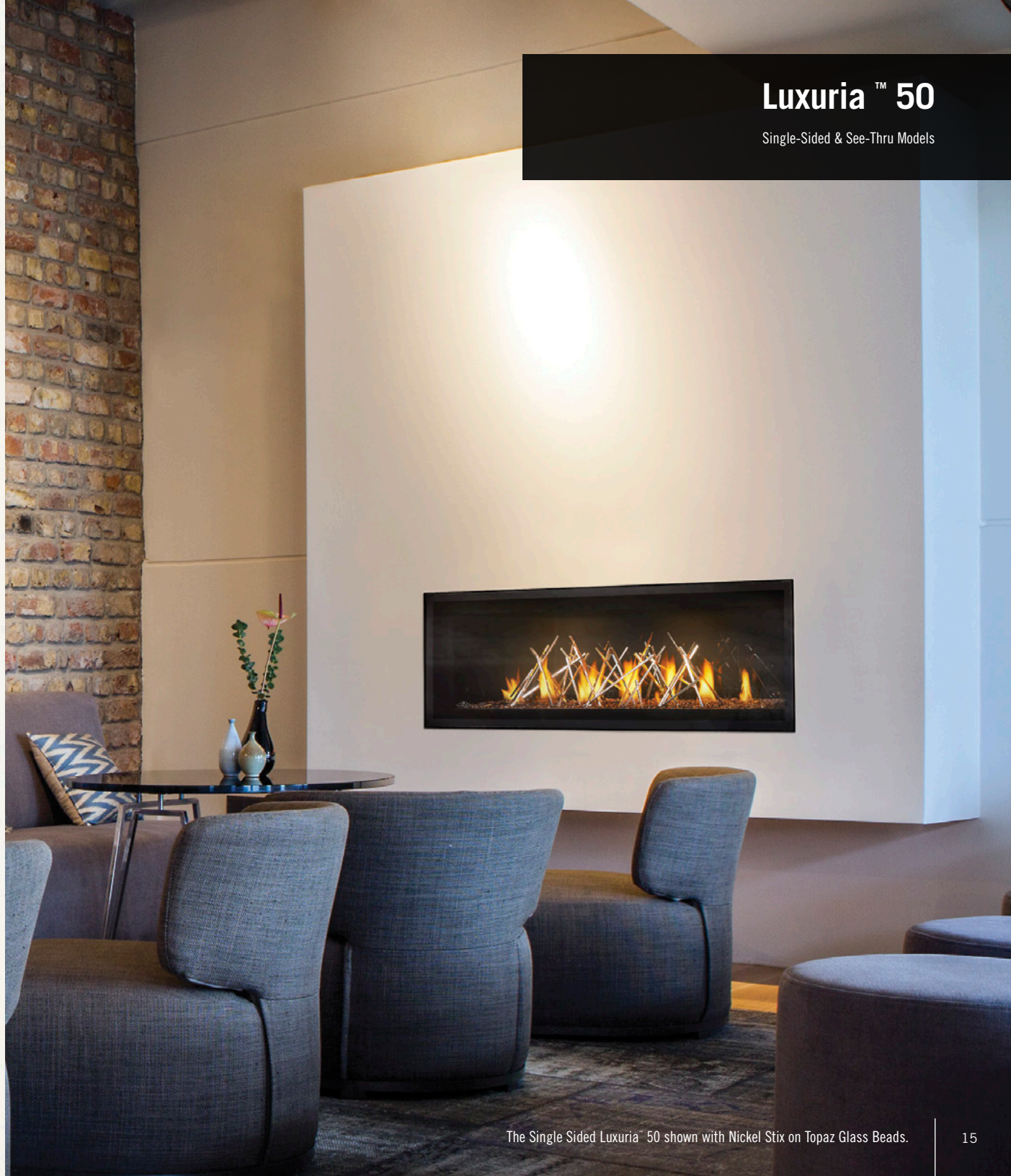

The Single Sided Luxuria™ 50 shown with Nickel Stix on Topaz Glass Beads.

# Luxuria™ 62

Single-Sided & See-Thru Models



Single Sided Luxuria™ 62



See-Thru Luxuria™ 62



Single Sided Luxuria™ 62



See-Thru Luxuria™ 62

## LVX62N / LVX62N2

Up to 44,000 BTU's

Viewing Area: 18 5/8" h x 66 1/8" w

For more detailed specifications on this unit, see pages 22-23



# Luxuria™ 74

Single-Sided & See-Thru Models



See-Thru Luxuria™ 74



Single Sided Luxuria™ 74



See-Thru Luxuria™ 74



Single Sided Luxuria™ 74

## LVX74N / LVX74N2

Up to 50,000 BTU's

Viewing Area: 18 5/8" h x 78 1/8" w

For more detailed specifications on this unit, see pages 22-23



## WHERE DESIGN MEETS COMFORT.

Napoleon's new patent pending heat management system, Dynamic Heat Control™ (DHC), is a system for managing the heat produced by the appliance at or around the fireplace, allowing it to circulate effectively within designated spaces. Design your living space how you imagine with versatile options that avoid complex and costly installation requirements.

*Enhance life's most memorable moments.*



Take advantage of simple installation framing. True zero clearance fireplace, combustible materials right up to fireplace opening with conventional, finishes and framing materials.

Choose from a wide range of finishing options, see below for some ideas:



wood    drywall    tile    concrete    stone    marble

## NO COMPROMISE FUNCTIONALITY.

This heat management system eliminates the need for loud power vents, fan systems or blowers to provide better heat distribution. Easily install your televisions, sound bars or artwork above the fireplace to truly customize your home decor thanks to the drastically reduced temperatures above the fireplace. Napoleon's Luxuria™ Series fireplaces includes the Dynamic Heat Control™ System and Premium Glass Guard, providing a completely unobstructed view of the tallest flames in the Linear Series, eliminating the need for safety screens! The DHC system is optional for the Vector™ Series fireplaces.

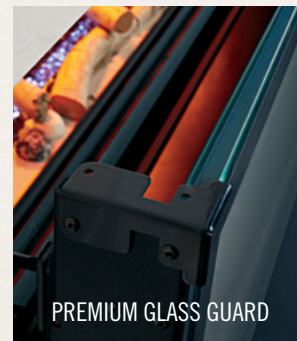

PREMIUM GLASS GUARD

## AWARD WINNING



On March 3rd, 2017, Napoleon's Luxuria™ series was recognized as "Best-In-Show" and was also awarded first place in the gas product category. Taking home two Vesta awards, the Luxuria line has further solidified Napoleon's stature as the leader in the hearth industry.

## COMING SOON



The Dynamic Heat Control™ Plus system takes heat management to the next level. The DHC Plus™ System is designed for advanced heat management even in the event of a power outage by directing warm air to any living space where heat is needed within the home, or even exhausting the heat outside if it is not required.

## FOCUSED ON VERSATILITY.

Engineered to optimize air flow both through the appliance and enclosure to reduce surface temperatures, this system allows for more versatile installation opportunities allowing for increased comfort. See below for examples of the Dynamic Heat Control<sup>™</sup> Fireplace installations options for virtually limitless possibilities.



Stopping shy of the ceiling at the top, allows rising hot air to escape freely from the top of the enclosure and into the room.



Uses an air outlet opening that will be built into the front of the constructed enclosure, at the top, centered above the appliance.

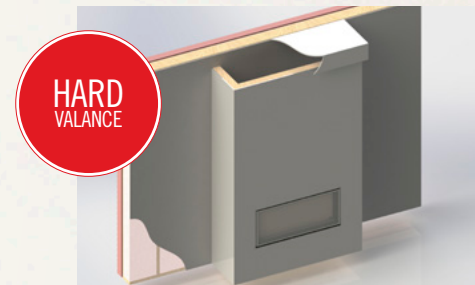

Stopping shy of the ceiling at the top, allows rising hot air to escape freely from the top of the enclosure and into the room.



This style of enclosure includes an air outlet opening that will be built into the rear of the constructed enclosure, at the top, centered above the appliance.



# Single Sided Vector™ Series

Dimensions & Specifications

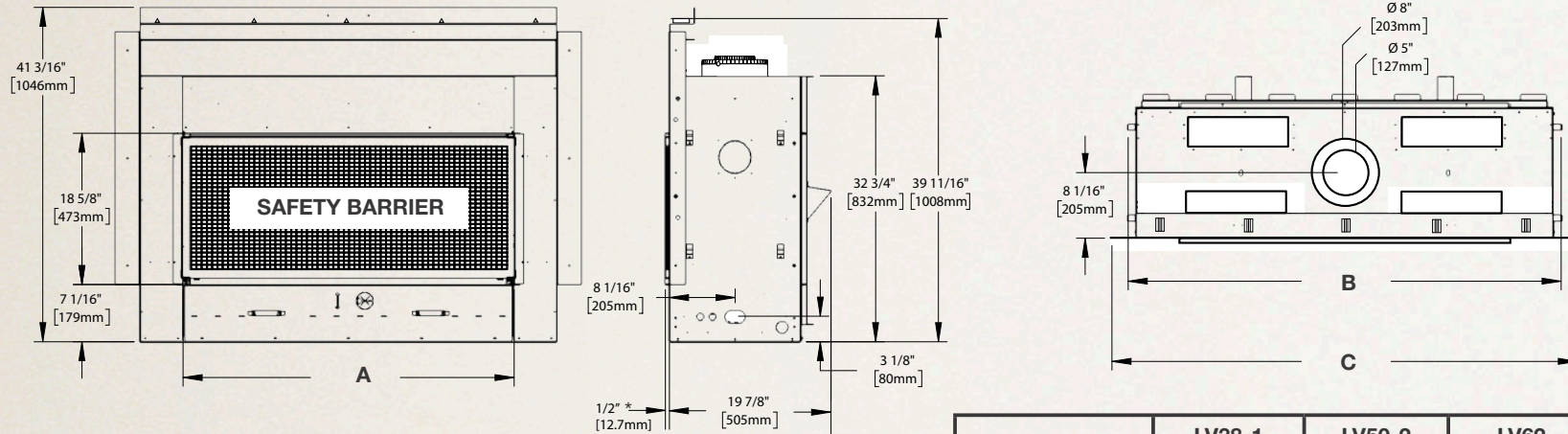

	LV38-1	LV50-2	LV62	LV74
<b>A</b> <b>(Finishing Flange)</b>	40 3/4" (1035mm)	52 3/4" (1340mm)	64 3/4" (1645mm)	76 3/4" (1949mm)
<b>B</b>	53 5/16" (1354mm)	65 5/16" (1659mm)	77 5/16" (1964mm)	89 5/16" (2269mm)
<b>C</b>	57 5/16" (1456mm)	69 5/16" (1761mm)	81 5/16" (2065mm)	93 5/16" (2370mm)

\*Finishing flange depth

Product Code	BTU's (Input)	Venting 5" / 8"	Height		Width		Depth		Viewing Area		Efficiency P4
			Actual	Framing	Actual	Framing	Actual	Framing	Height	Width	
LV38N	30,000	Top	39 3/4"	40" **	53 5/16"	56 3/16"	20"	20 1/8"	18 5/8"	40 3/4"	38.8%
LV50N	36,000	Top	39 3/4"	40" **	65 5/16"	65 13/16"	20"	20 1/8"	18 5/8"	52 3/4"	45.9%
LV62N	42,000	Top	39 3/4"	40" **	77 5/16"	77 13/16"	20"	20 1/8"	18 5/8"	64 3/4"	52.5%
LV72N	48,000	Top	39 3/4"	40" **	89 5/16"	89 13/16"	20"	20 1/8"	18 5/8"	76 3/4"	52.5%

\*\* Non-Combustible Header, Framing and Finishing Material **MAY** be required.

# See-Thru Vector™ Series

Dimensions & Specifications

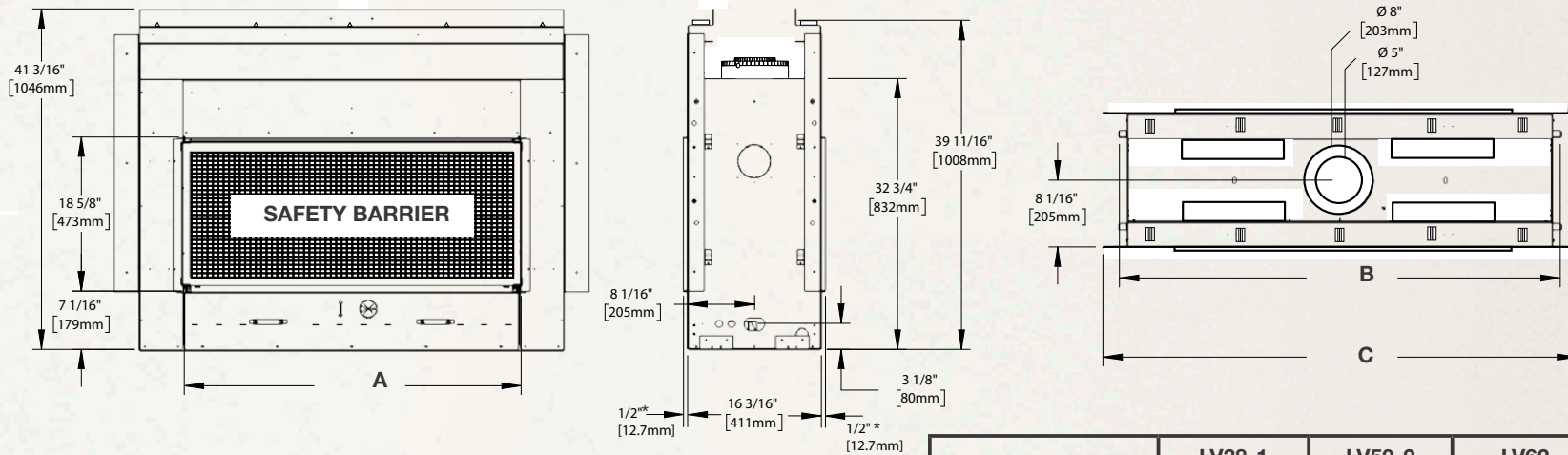

	LV38-1	LV50-2	LV62	LV74
<b>A</b> (Finishing Flange)	40 3/4" (1035mm)	52 3/4" (1340mm)	64 3/4" (1645mm)	76 3/4" (1949mm)
<b>B</b>	53 5/16" (1354mm)	65 5/16" (1659mm)	77 5/16" (1964mm)	89 5/16" (2269mm)
<b>C</b>	57 5/16" (1456mm)	69 5/16" (1761mm)	81 5/16" (2065mm)	93 5/16" (2370mm)

\*Finishing flange depth

Product Code	BTU's (Input)	Venting 5" / 8"	Height		Width		Depth		Viewing Area (per side)		Efficiency P4
			Actual	Framing	Actual	Framing	Actual	Framing	Height	Width	
LV38N2	30,000	Top	39 3/4"	40" **	53 5/16"	53 13/16"	16 3/16"	16 3/16"	18 5/8"	40 3/4"	38.8%
LV50N2	36,000	Top	39 3/4"	40" **	65 5/16"	65 13/16"	16 3/16"	16 3/16"	18 5/8"	52 3/4"	45.9%
LV62N2	42,000	Top	39 3/4"	40" **	77 5/16"	77 13/16"	16 3/16"	16 3/16"	18 5/8"	64 3/4"	52.5%
LV72N2	48,000	Top	39 3/4"	40" **	89 5/16"	89 13/16"	16 3/16"	16 3/16"	18 5/8"	76 3/4"	52.5%

# Single Sided Luxuria™ Series

Dimensions & Specifications

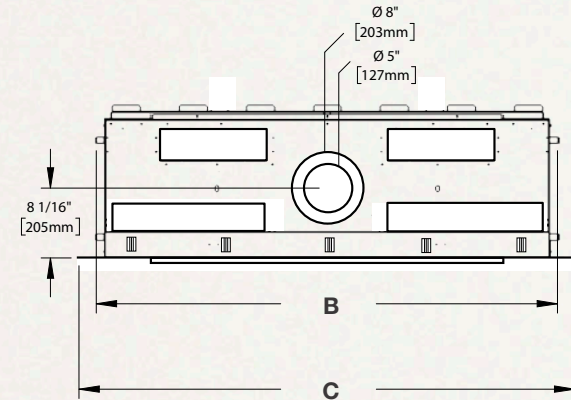
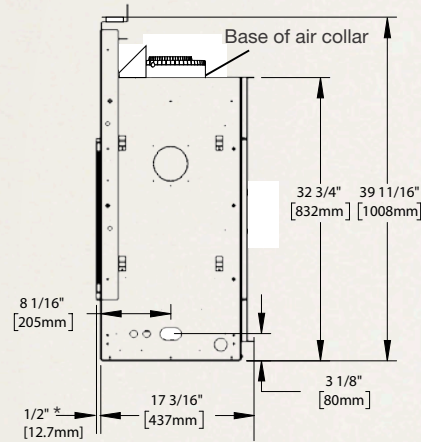
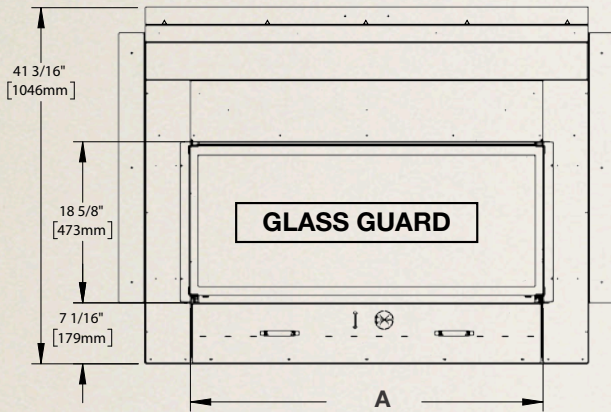

	LVX38	LVX50	LVX62	LVX74
<b>A</b> <b>(Finishing Flange)</b>	42 1/8" (1070mm)	54 1/8" (1375mm)	66 1/8" (1680mm)	78 1/8" (1984mm)
<b>B</b>	53 5/16" (1354mm)	65 5/16" (1659mm)	77 5/16" (1964mm)	89 5/16" (2269mm)
<b>C</b>	57 5/16" (1456mm)	69 5/16" (1761mm)	81 5/16" (2065mm)	93 5/16" (2370mm)

\*Finishing flange depth (the finishing flange defines the perimeter of the fireplace opening. Framing or finishing materials must NEVER encroach inside the finishing flange).

Product Code	BTU's (Input)	Venting 5" / 8"	Height		Width		Depth		Viewing Area		Efficiency P4
			Actual	Framing	Actual	Framing	Actual	Framing	Height	Width	
LVX38N	30,000	Top	39 3/4"	40"	53 5/16"	53 13/16"	17 11/16"	18"	18 5/8"	42 1/8"	40.1%
LVX50N	36,000	Top	39 3/4"	40"	65 5/16"	65 13/16"	17 11/16"	18"	18 5/8"	54 1/8"	45.5%
LVX62N	42,000	Top	39 3/4"	40"	77 5/16"	77 13/16"	17 11/16"	18"	18 5/8"	66 1/8"	55.5%
LVX72N	48,000	Top	39 3/4"	40"	89 5/16"	89 13/16"	17 11/16"	18"	18 5/8"	78 1/8"	52.5%

# See-Thru Luxuria™ Series

Dimensions & Specifications

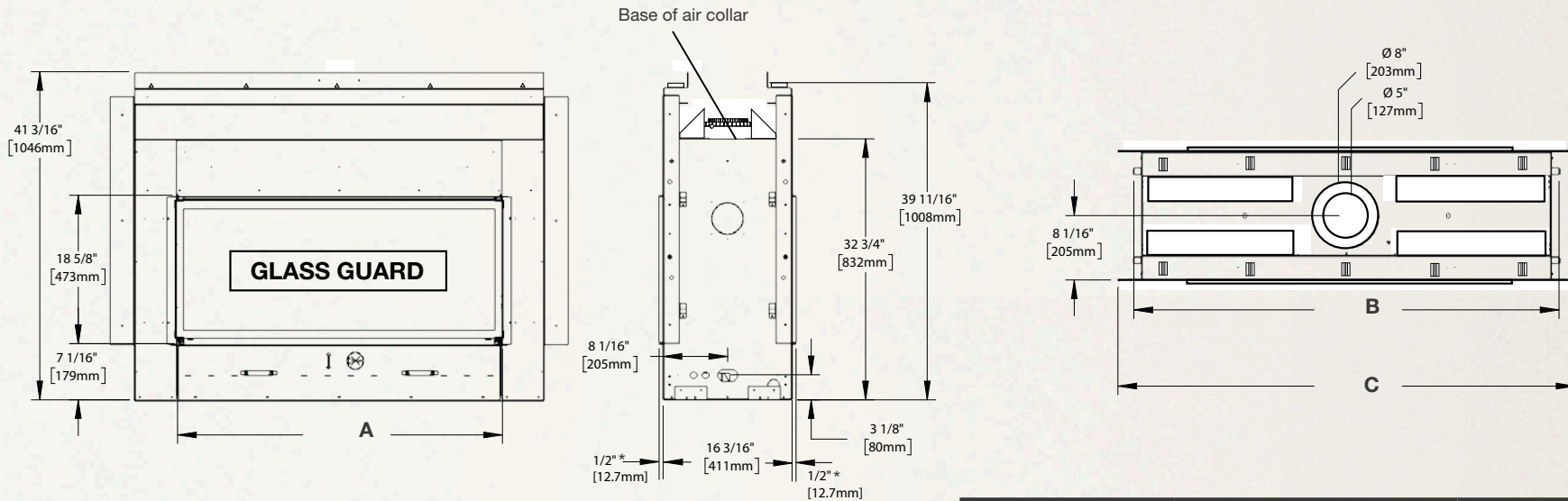

	LVX38	LVX50	LVX62	LVX74
<b>A</b> <b>(Finishing Flange)</b>	42 1/8" (1070mm)	54 1/8" (1375mm)	66 1/8" (1680mm)	78 1/8" (1984mm)
<b>B</b>	53 5/16" (1354mm)	65 5/16" (1659mm)	77 5/16" (1964mm)	89 5/16" (2269mm)
<b>C</b>	57 5/16" (1456mm)	69 5/16" (1761mm)	81 5/16" (2065mm)	93 5/16" (2370mm)

\*Finishing flange depth (the finishing flange defines the perimeter of the fireplace opening. Framing or finishing materials must NEVER encroach inside the finishing flange).

Product Code	BTU's (Input)	Venting 5" / 8"	Height		Width		Depth		Viewing Area (per side)		Efficiency P4
			Actual	Framing	Actual	Framing	Actual	Framing	Height	Width	
LVX38N2	30,000	Top	39 3/4"	40"	53 5/16"	53 13/16"	16 3/16"	16 3/16"	18 5/8"	42 1/8"	40.1%
LVX50N2	36,000	Top	39 3/4"	40"	65 5/16"	65 13/16"	16 3/16"	16 3/16"	18 5/8"	54 1/8"	45.5%
LVX62N2	42,000	Top	39 3/4"	40"	77 5/16"	77 13/16"	16 3/16"	16 3/16"	18 5/8"	66 1/8"	55.5%
LVX72N2	48,000	Top	39 3/4"	40"	89 5/16"	89 13/16"	16 3/16"	16 3/16"	18 5/8"	78 1/8"	52.5%



# NAPOLEON - CELEBRATING OVER 40 YEARS OF HOME COMFORT PRODUCTS



24 Napoleon Road, Barrie, Ontario, Canada L4M 0G8  
103 Miller Drive, Crittenden, Kentucky, USA 41030  
7200 Trans Canada Highway, Montreal, Quebec, Canada H4T 1A3

Tel: 1-866-820-8686  
napoleonfireplaces.com

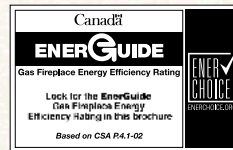

Authorized Dealer

Consult your owner's manual for complete installation instructions and proper clearances to combustible materials. Check all local and national building codes and gas regulations. All specifications are subject to change without prior notice due to on-going product improvements. Products may not be exactly as shown. Flame height and activity is influenced by varying vent configurations and may not appear as shown. Napoleon is a registered trademark of Wolf Steel Ltd. © Wolf Steel Ltd. EnerGuide - A Canadian efficiency standard based on frequent, short start-up and cool-down cycles. All appliances sold in Canada are subject to this EnerGuide rating system. AFUE - A US efficiency standard (Department of Energy) based on extended on/off cycles, more typical of fireplace usage. Steady State - Reflects the highest possible overall heating efficiency.