

TOP VIEW

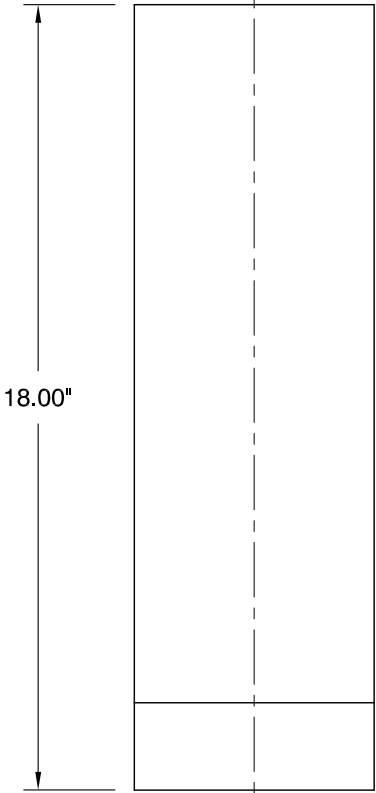

FRONT VIEW

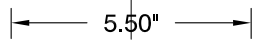
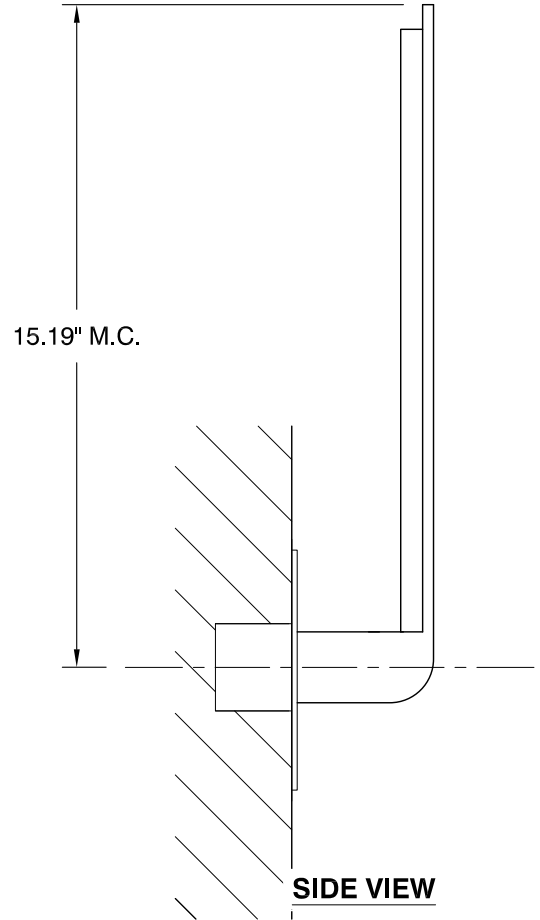

SIDE VIEW

HALO sconce
 120v **3-515-40**
 277v **37-515-40**

OXYGEN LIGHTING ©

LAMPING

- o (1x) 10.1w LED array
- o 3000K, 350mA
- o Initial Lumens: 1460 lm
- o Delivered Lumens: TBD
- o CRI > 80
- o Color Consistency: 3 Step MacAdams Ellipse

DRIVER (Dimmable)

- o (1x) 0-10v & Reverse Phase Dimming Constant Current, 12w, 350mA

METAL FINISHES

- o **14** - Polished Chrome
- o **24** - Satin Nickel
- o **25** - Satin Copper
- o **40** - Aged Brass

DIFFUSER

- o Matte White Acrylic

INPUT VOLTAGE

- o 120v OR 277v 50/60Hz

DIMENSIONS

- o 5.50" (w) x 18.00" (h) x 3.25" (ext.)

INSTALLATION

- o 4" J-Box
- o ETL Dry/Damp Listed
- o ADA
- o Conforms to UL STD 1598
- o Certified CAN/CSA STD C22.2 No. 250.0



Sample Catalog Number		
Series #	Finish	Catalog Number
3-515	24	3-515-24

oxygen

OXYGEN LIGHTING
 201 RAILHEAD RD, FORT WORTH, TX 76106
 TEL. (877) 607-0202 FAX (877) 607-0203
 WWW.OXYGENLIGHTING.COM

PROJECT: _____
 DATE: _____

