

Eco-Downlight LED

3" Recessed Downlight

Remodel / Retrofit

EDL-RM Series – 120-277V

16W – 50/60 Hz

Fixture

- Integral 120-277V input LED Driver, 16W, 90% efficient, 0.99 power factor
- Emergency remote battery backup available
- UL/C-UL Listed for damp location



LEDs

- Warm White – 16W, 2,800°K, ±100, CRI 85, 1250 lm
- Soft White – 16W, 3,500°K ±100, CRI 85, 1250 lm
- Natural White – 16W, 4,000°K ±100, CRI 80, 1250 lm
- 50,000 hours at 70% lumen maintenance (L70)
- LM79 test results available at csllighting.com
- Compatible with Triac (INC) dimmers
- Field-replaceable light engine and driver
- Light engine coded for performance maintenance replacement

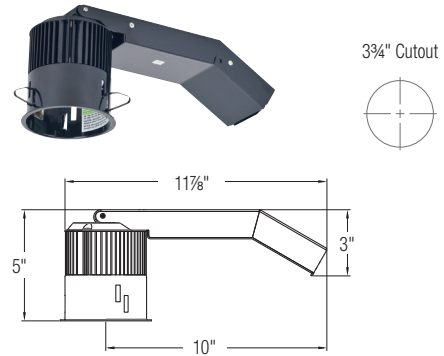

120-277V 16W Integral Driver

50/60 Hz, INC dimmable, EM ready

<input type="checkbox"/>	EDL-RM-WW-3	Warm White LED, 2,800°K ±100°K, CRI 85, 1250 lm
<input type="checkbox"/>	EDL-RM-SW-3	Soft White LED, 3,500°K ±100°K, CRI 85, 1250 lm
<input type="checkbox"/>	EDL-RM-NW-3	Natural White LED, 4,000°K ±100°K, CRI 80, 1250 lm

Housing/Heat Sink

- Extruded aluminum heat sink with black anodized finish
- Cold-rolled steel housing with black powder-coat finish
- Includes black oxide-coated, heat-treated spring steel mounting clips
- Adjusts vertically to accommodate ceiling thicknesses from 1/2" to 1"
- Stamped aluminum junction box with two 1/2" trade-size knockouts

Project _____

Fixture Type _____

Location _____

Contact _____

Phone _____



A Division of Troy-CSL Lighting, Inc.

14508 Nelson Avenue City of Industry CA 91744 Tel: 626.336.4511 Fax: 626.330.4266 www.csllighting.com

Eco-Downlight LED

3" Trims

Materials

- Trim rings: Diecast aluminum
- Reflectors and baffles:
Round – Spun aluminum and diecast aluminum
Square – Diecast aluminum

Finishes

- Standard Finishes:
White Powder-Coat, Satin Aluminum, Bronze
- RAL color matching available (consult factory)

Accessories

- Trims ship with three optic lenses: 25°, 45° and 65°
- Optional 85° optic available
- Three optional glass lenses available:
Clear, Frost, Mini-Prismatic*
- Trims can accommodate up to two glass accessories*
*Non-adjustable only

Photometrics

- See www.csllighting.com for current photometric data

3" Round Trims

NUMBER	TRIM FINISH	REFLECTOR/BAFFLE
<input type="checkbox"/> EDL-1000-3	White	Clear Alzak Reflector
<input type="checkbox"/> EDL-1001-3	White	Black Alzak Reflector
<input type="checkbox"/> EDL-1002-3	Satin Aluminum	Clear Alzak Reflector
<input type="checkbox"/> EDL-1003-3	Satin Aluminum	Black Alzak Reflector
<input type="checkbox"/> EDL-1004-3	White	Haze Reflector
<input type="checkbox"/> EDL-1005-3	Satin Aluminum	Haze Reflector
<input type="checkbox"/> EDL-1006-3	White	White Reflector
<input type="checkbox"/> EDL-1007-3	Bronze	Bronze Reflector
<input type="checkbox"/> EDL-1100-3	White	White Baffle
<input type="checkbox"/> EDL-1101-3	White	Black Baffle
<input type="checkbox"/> EDL-1102-3	Satin Aluminum	Black Baffle
<input type="checkbox"/> EDL-1103-3	Bronze	Bronze Baffle
<input type="checkbox"/> EDL-1200-3	White	Shower Light
<input type="checkbox"/> EDL-1201-3	Satin Aluminum	Shower Light

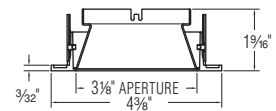

EDL-1000 Series

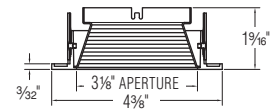

EDL-1100 Series

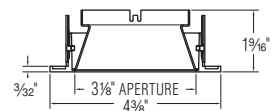

EDL-1200

3" Square Trims

NUMBER	TRIM FINISH	REFLECTOR/BAFFLE
<input type="checkbox"/> EDL-2000-3	White	White Reflector
<input type="checkbox"/> EDL-2001-3	White	Black Reflector
<input type="checkbox"/> EDL-2002-3	White	Haze Reflector
<input type="checkbox"/> EDL-2003-3	Satin Aluminum	Black Reflector
<input type="checkbox"/> EDL-2004-3	Satin Aluminum	Haze Reflector
<input type="checkbox"/> EDL-2005-3	Bronze	Bronze Reflector
<input type="checkbox"/> EDL-2100-3	White	White Baffle
<input type="checkbox"/> EDL-2101-3	White	Black Baffle
<input type="checkbox"/> EDL-2102-3	Satin Aluminum	Black Baffle
<input type="checkbox"/> EDL-2103-3	Bronze	Bronze Baffle
<input type="checkbox"/> EDL-2200-3	White	Shower Light
<input type="checkbox"/> EDL-2201-3	Satin Aluminum	Shower Light

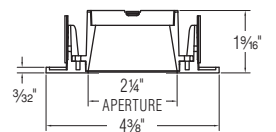

EDL-2000 Series

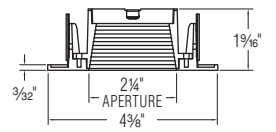

EDL-2100 Series

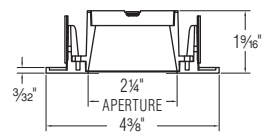

EDL-2200



A Division of Troy-CSL Lighting, Inc.

14508 Nelson Avenue City of Industry CA 91744 Tel: 626.336.4511 Fax: 626.330.4266 www.csllighting.com

Eco-Downlight LED

3" Accessories

3" Accessories

NUMBER	DESCRIPTION
<input type="checkbox"/> EDL-RD-TL	Round Trimless Ring
<input type="checkbox"/> EDL-SQ-TL	Square Trimless Ring
<input type="checkbox"/> EDL-RD-CL	Round Glass - Clear
<input type="checkbox"/> EDL-RD-FT	Round Glass - Frost
<input type="checkbox"/> EDL-RD-MPR	Round Glass - Mini-Prismatic
<input type="checkbox"/> EDL-SQ-CL	Square Glass - Clear
<input type="checkbox"/> EDL-SQ-FT	Square Glass - Frost
<input type="checkbox"/> EDL-SQ-MPR	Square Glass - Mini-Prismatic
<input type="checkbox"/> EDL-85-OPTIC	85° Optic



3" Round Trimless Ring

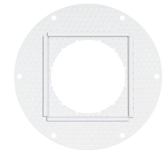

3" Square Trimless Ring



3" Glass Accessories



A Division of Troy-CSL Lighting, Inc.

14508 Nelson Avenue City of Industry CA 91744 Tel: 626.336.4511 Fax: 626.330.4266 www.csllighting.com

EDL3-RM_V2.0

Eco-Downlight LED



A Division of Troy-CSL Lighting, Inc.

14508 Nelson Avenue City of Industry CA 91744 Tel: 626.336.4511 Fax: 626.330.4266 www.csllighting.com

EDL3-RM_V2.0