

INSTALLATION MANUAL FOR UNDERCOUNTERS, WORKTOPS, SANDWICH/SALAD, PIZZA PREP, & FOOD PREP

Spanish, German, French, Dutch, Portuguese, and Polish versions included.

TABLE OF CONTENTS

► **Safety Information**

Safety Precautions	1
Proper Disposal	2
Connecting Electricity	3
Adapter Plugs	3

► **Installation / Operation Instructions**

Ownership	4
Required Tools	4
Uncrating	4
Locating & Clearances	5
Installation of Leg/Castors (TSSU, TWT, TUC, TPP)	6
Leveling and Castor Adjustment for TFP Models	7
Pizza Prep Tables	8
Installing TSSU Hood Cover	8
Leveling Cabinet	9
Electrical Instructions	9
Wire Gauge Chart	10
Start-up	11
Cabinet Air-Flow	11
Temperature Control Location & Setting for TFP	12
Temperature Control Adjustment High Altitude	12
LAE Temperature Control (TUC-24-HC/TUC-24G-HC)	13-19
TSSU-27-12M-C Chiller Hose	20
Shelving Install/Operation & Light Switch	21
TFP Drawer Removal & Installation	22

► **Maintenance, Care & Cleaning**

Cleaning Condenser Coil	23-24
Stainless Steel Equipment Care & Cleaning	25-26
Composite Cutting Board Maintenance	26
Periodic Maintenance for Lids	27
Warranty (U.S.A. & Canada Only!)	28



TUC-27



TFP-48-18M-D-4



TSSU-48-10



TPP-67



TWT-67D-2

CONGRATULATIONS!

You have just purchased the finest commercial refrigerator available. You can expect many years of trouble-free operation.

UNDERCOUNTERS, WORKTOPS, SANDWICH/SALAD, PIZZA PREP, & FOOD PREP

(FOOD PREP (TFP) MODELS ONLY AVAILABLE IN 115v/60Hz VOLTAGE)

NOTICE TO CUSTOMER:



**Loss Or Spoilage Of Products
In Your Refrigerator/Freezer
Is NOT Covered By Warranty.
In Addition To Following
Recommended Installation
Procedures You Must Run
The Refrigerator/Freezer
24 Hours Prior To Usage.**

True Manufacturing Company, Inc.

SAFETY INFORMATION

How to Maintain Your TRUE Unit to Receive the Most Efficient and Successful Operation

You have selected one of the finest commercial refrigeration units made. It is manufactured under strict quality controls with only the best quality materials available. Your TRUE cooler when properly maintained will give you many years of trouble-free service.

WARNING!

Use this appliance for its intended purpose as described in this Owner Manual.

TO LOCATE REFRIGERANT TYPE, SEE SERIAL LABEL INSIDE CABINET.

This cabinet may contain fluorinated greenhouse gas covered by the Kyoto Protocol (please refer to cabinet's inner label for type and volume, GWP of 134a= 1,300. R404a= 3,800).

For Hydrocarbon Refrigeration Only (R-290) See Below:

- **Danger** - Risk of fire or explosion. Flammable refrigerant used. Do not use mechanical devices to defrost refrigerator. Do not puncture refrigerant tubing.
- **Danger** - Risk of fire or explosion. Flammable refrigerant used. To be repaired only by trained service personnel. Do not puncture refrigerant tubing.
- **Caution** - Risk of fire or explosion. Flammable refrigerant used. Consult repair manual/owner's guide before attempting to service this product. All safety precautions must be followed.
- **Caution** - Risk of fire or explosion. Dispose of properly in accordance with federal or local regulations. Flammable refrigerant used.
- **Caution** - Risk of fire or explosion due to puncture of refrigerant tubing; follow handling instructions carefully. Flammable refrigerant used.
- **Caution** - Keep clear of obstruction all ventilation openings in the appliance enclosure or in the structure for building-in.

SAFETY PRECAUTIONS

When using electrical appliances, basic safety precautions should be followed, including the following:

- This refrigerator must be properly installed and located in accordance with the Installation Instructions before it is used.
- Do not allow children to climb, stand or hang on the shelves in the refrigerator. They could damage the refrigerator and seriously injure themselves.
- Do not touch the cold surfaces in the refrigerator compartment when hands are damp or wet. Skin may stick to these extremely cold surfaces.
- Do not store or use gasoline or other flammable vapors and liquids in the vicinity of this or any other appliance.
- Keep fingers out of the "pinch point" areas; clearances between the doors and between the doors and cabinet are necessarily small; be careful closing doors when children are in the area.

NOTE

We strongly recommend that any servicing be preformed by a qualified individual.

- Unplug the refrigerator before cleaning and making repairs.
- Setting temperature controls to the 0 position does not remove power.

SAFETY INFORMATION

DANGER!

RISK OF CHILD ENTRAPMENT

PROPER DISPOSAL OF THE REFRIGERATOR

Child entrapment and suffocation are not problems of the past. Junked or abandoned refrigerators are still dangerous... even if they will sit for “just a few days.” If you are getting rid of your old refrigerator, please follow the instructions below to help prevent accidents.

Before You Throw Away Your Old Refrigerator or Freezer:

- Take off the doors.
- Leave the shelves in place so that children may not easily climb inside.

Refrigerant Disposal

Your old refrigerator may have a cooling system that uses “Ozone Depleting” chemicals. If you are throwing away your old refrigerator, make sure the refrigerant is removed for proper disposal by a qualified service technician. If you intentionally release any refrigerants you can be subject to fines and imprisonment under provisions of the environmental regulations.

USE OF EXTENSION CORDS

NEVER USE AN EXTENSION CORD! TRUE will not warranty any refrigerator that has been connected to an extension cord.

REPLACEMENT PARTS

- Component parts shall be replaced with like components.
- Servicing shall be done by authorized service personnel, to minimize the risk of possible ignition due to incorrect parts or improper service.
- Lamps must be replaced by identical lamps only.
- If the supply cord is damaged, it must be replaced by a special cord or assembly available from the manufacturer or its service agent.

SAFETY INFORMATION

WARNING!

HOW TO CONNECT ELECTRICITY

Do not, under any circumstances, cut or remove the ground prong from the power cord. For personal safety, this appliance must be properly grounded.

The power cord from this appliance is equipped with a grounding plug which minimizes the possibility of electric shock hazard.

Have the wall outlet and circuit checked by a qualified electrician to make sure the outlet is properly grounded.

If the outlet is a standard 2-prong outlet, it is your personal responsibility and obligation to have it replaced with the properly grounded wall outlet.

The refrigerator should always be plugged into it's own individual electrical circuit, which has a voltage rating that matches the rating plate.

This provides the best performance and also prevents overloading building wiring circuits which could cause a fire hazard from overheated wires.

Never unplug your refrigerator by pulling on the power cord. Always grip plug firmly and pull straight out from the outlet.

Repair or replace immediately all power cords that have become frayed or otherwise damaged. Do not use a cord that shows cracks or abrasion damage along its length or at either end.

When removing the refrigerator away from the wall, be careful not to roll over or damage the power cord.

USE OF ADAPTER PLUGS

NEVER USE AN ADAPTER PLUG! Because of potential safety hazards under certain conditions, we strongly recommend against the use of an adapter plug.

The incoming power source to the cabinet including any adapters used must have the adequate power available and must be properly grounded. Only adapters listed with UL should be used.

(North America Use Only!)
 NEMA plugs

TRUE uses these types of plugs. If you do not have the right outlet have a certified electrician install the correct power source.



115/60/1
 NEMA-5-15R

INSTALLATION / OPERATION INSTRUCTIONS

INSTALLATION / OPERATION INSTRUCTIONS

OWNERSHIP

To ensure that your unit works properly from the first day, it must be installed properly. We highly recommend a trained refrigeration mechanic and electrician install your **TRUE** equipment. The cost of a professional installation is money well spent.

Before you start to install your **TRUE** unit, carefully inspect it for freight damage. If damage is discovered, immediately file a claim with the delivery freight carrier. **TRUE is not responsible for damage incurred during shipment.**

REQUIRED TOOLS

- Adjustable Wrench
- Phillips Head Screwdriver
- Level

UNCRATING

The following procedure is recommended for uncrating the unit:

- A.** Remove the outer packaging, (cardboard and bubbles or styrofoam corners and clear plastic). Inspect for concealed damage. Again, immediately file a claim with the freight carrier if there is damage.
- B.** Move your unit as close to the final location as possible before removing the wooden skid.
- C.** Remove door bracket on swing glass door models (see image 1-2).

NOTE

Keys for coolers with door locks are located in warranty packets.

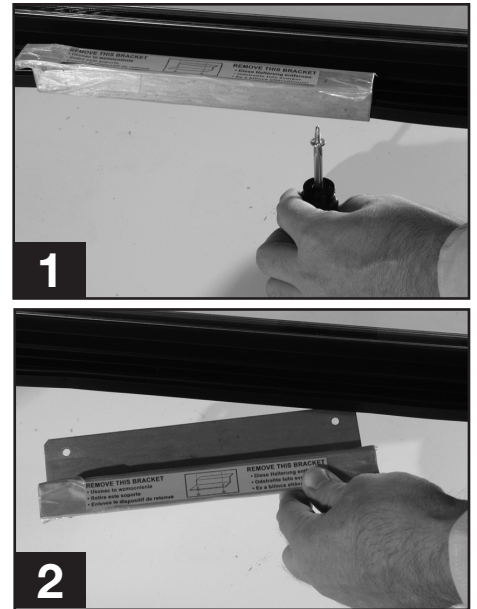

Glass Door Models Only.

REMOTE UNITS (This section applies to remotes only!)

- Remote cabinets must be ordered as remote. We do not recommend converting for a standard self contained to remote system.
- All remote cabinets must be hard wired.
- No castors available.
- All remote cabinets come standard using 404A refrigerant.
- All remote units come standard with expansion valve, liquid line solenoid, heated condensate pan, and defrost timer when applicable.

- Contact TRUE Technical Service for BTU requirements.
- No wiring necessary between cabinet and condensing unit.
- All remote condensing units purchased from TRUE are 208/230 volts single phase.

If you have any questions regarding this section, please call TRUE at 1-(800)-325-6152.

INSTALLATION / OPERATION INSTRUCTIONS

LOCATING

- A. Place packing material behind cabinet as a cushion. Carefully lay the unit on its back to remove skid.

When lifting unit remember to leave the cabinet upright for 24 hours before plugging into power source.



Removing skid from bottom of cabinet.

- B. Remove skid by unscrewing all base rail anchor brackets. Place skid to the side.
- C. Carefully lift cabinet upright.
- D. Before removing unit off the shipping skid be sure not to damage drain pan at the base of the unit.
- E. Appliance tested according to the climate classes 5 and 7 for temperature and relative humidity.

WARNING: Be sure there is adequate ventilation in your room. Under extreme heat conditions, (100°F+, 38°C+), you may want to install an exhaust fan. Warranty is void if ventilation is insufficient.

CLEARANCES: (For proper cabinet operation, clearance guidelines should be followed.)

TPP, TSSU, TUC, & TWT

Unless otherwise noted – 1” at the rear, 0” at the sides, and 0” at the top.

TFP, TUC-24-HC, TUC-24G-HC-LD

0” at the rear, 0” at the sides, and 0” at the top.

INSTALLATION / OPERATION INSTRUCTIONS

INSTALLATION OF LEGS AND CASTORS

TSSU, TWT, TUC, TPP

Important Safeguard for installation of leg/castor (Images 1-5 demonstrate procedure)

Securing Castors and Legs

To obtain maximum strength and stability of the unit, it is important that you make sure each castor is secure. Legs are hand-tightened securely against the lower rail assembly. The bearing race on the castor of the top edge of the leg must make firm contact with the rail.

Unit leveling

Four leveling shims have been provided for leveling castored units positioned on uneven floors. Shims must be positioned between rail end and bearing race. TRUE requires a four shim limit to each individual castor.

A. Turn the bearing race counter-clockwise until the cabinet is level. Level front to back and side to side. (diagonally)

- B.** Install the desired number of shims, making sure the slot of the shim is in contact with the threaded stem of the castor.
- C.** If more than one shim is used, turn the slot at a 90° angle so they are not in line.
- D.** Turn the bearing race clockwise to tighten and secure the castor by tightening the anchoring bolt with a 3/4 inch open-end wrench or the tool provided.

CAUTION

To avoid damage to lower rail assembly, slowly raise unit to upright position.



1 Thread castor into the underside of cabinet frame rail.



2 For leveling, insert the shim between the castor and frame rail.



3 Use the tool provided to tighten the castor into place.



4 Thread leg into cabinet bottom frame rail.



5 The end of the leg is adjustable to easy leveling.

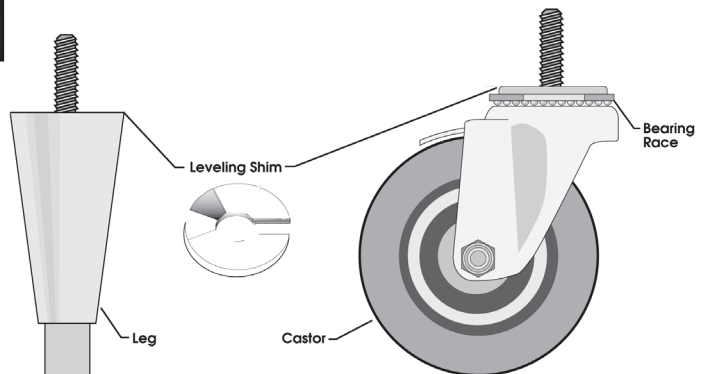

INSTALLATION / OPERATION INSTRUCTIONS

LEVELING AND CASTOR ADJUSTING TFP MODELS ONLY

Adjusting Castors for Proper Leveling

Level unit. If unit is not level shims are required. Follow these instructions to install shims.

1. Remove front and rear grill depending upon which castor needs adjusting. Locate the castor box. (See image 1).
2. Lay unit on it's back. Use soft packing material and be careful not to scratch the unit. Remove pans and lid and place them to the side before laying unit on it's back.
3. Each unit has one castor box different from the others. This box is totally inclosed. Remove this castor box from bottom of unit. Back out four screws anchoring the box. You will need a 1/4" hex head nut driver to disassemble this castor box. (See image 2).
4. Loosen castor with tool provided. (See image 3).
5. Install the desired number of shims, making sure the slot of the shim is in contact with the threaded stem of the castor. (See image 4). If more than one shim is used, turn the slot at a 90° angle so they are not in line.
6. After adjusting castor reassemble and reinstall castor box. Then carefully upright unit and reinstall pans and lid.

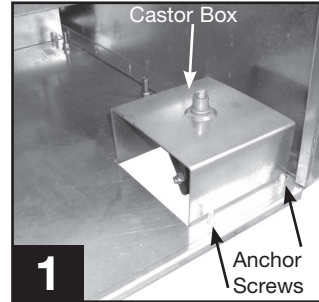

1 Locate castor box

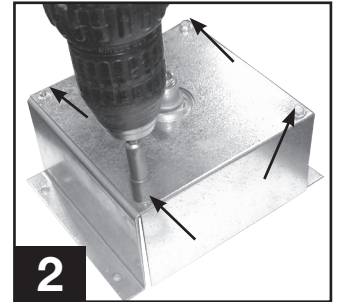

2 One castor box on each unit is fully enclosed.

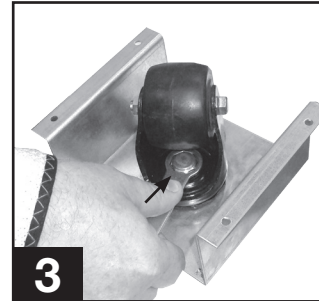

3 Loosen castor.

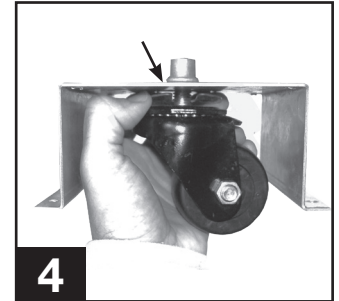

4 Install shims.

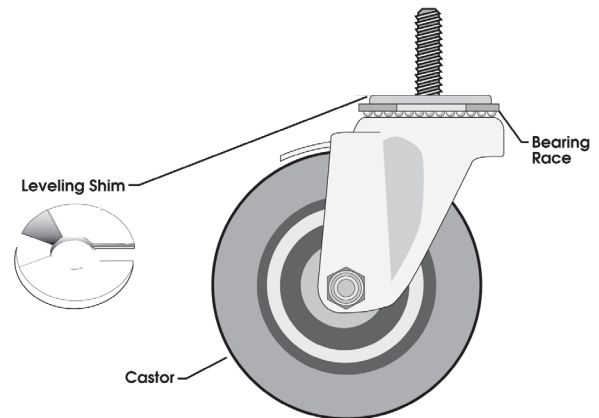

INSTALLATION / OPERATION INSTRUCTIONS

PIZZA PREP TABLES

- A. Remove rear grill and thread electric cord through grommet in grill.
- B. Replace grill.
- C. Align cutting board with Rivnuts and attach retainer clip to table top (figure 1).
- D. Install the lid brackets. Note that there is a specifically designed left, center (if applicable), and right bracket.

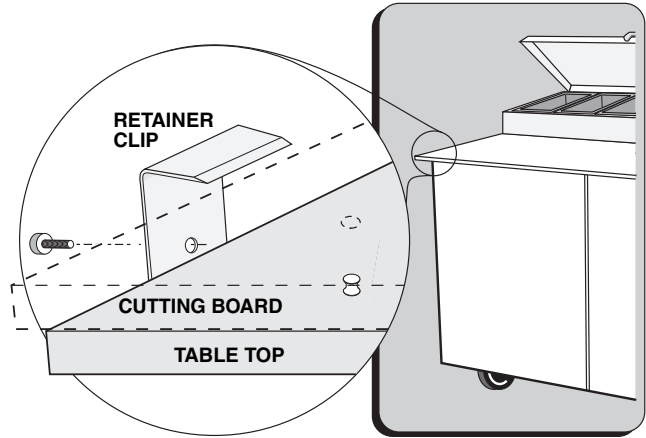

Figure 1.

ANCHORING THE TSSU HOOD COVER

TSSU Hood Installation Instruction

Assembly

- 1. Locate the lid, (packaged within the cardboard container on top of the salad sandwich unit), and position under the hood.
- 2. Insert lid into hood while flexing the ends inward. Make sure lid handle is facing out of the hood. (See image 1).
- 3. Let the ends of the lid flex back into position. Hinge pins located in the hood slide into sides of the lid hinge pin holes. (See image 2).

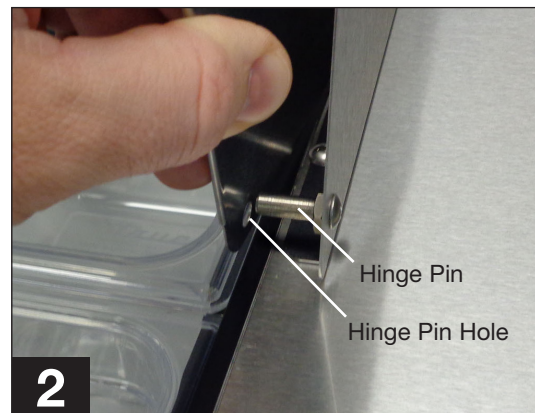
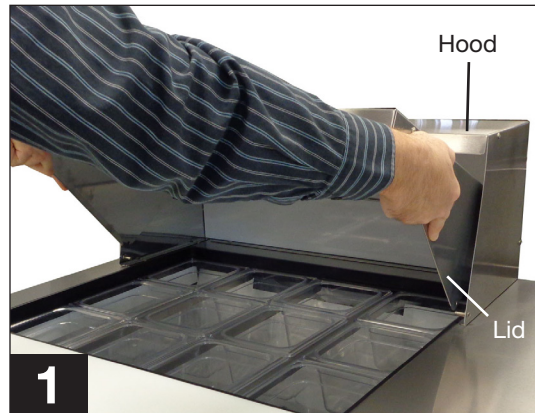

INSTALLATION / OPERATION INSTRUCTIONS

LEVELING

A. Set unit in its final location. Be sure there is adequate ventilation in your room. Under extreme heat conditions, (100°F+, 38°C+), you may want to install an exhaust fan.

WARNING

Warranty is void if ventilation is insufficient.

B. Proper leveling of your TRUE cooler is critical to operating success (for non-mobile models). Effective condensate removal and door operation will be effected by leveling.

C. The cooler should be leveled from inside the cabinet. Place a level on the inside floor of the unit front to back and side to side.

D. Ensure that the drain hose or hoses are positioned in the pan.

E. Free plug and cord from inside the lower rear of the cooler (do not plug in).

F. The unit should be placed close enough to the electrical supply so that extension cords are never used.

WARNING

Cabinet warranties are void if OEM power cord is tampered with. TRUE will not warranty any units that are connected to an extension cord.

ELECTRICAL INSTRUCTIONS

A. Before your new unit is connected to a power supply, check the incoming voltage with a voltmeter. If anything less than 100% of the rated voltage for operation is noted, correct immediately.

B. All units are equipped with a service cord, and must be powered at proper operating voltage at all times. Refer to cabinet data plate for this voltage.

TRUE requires that a sole use circuit be dedicated for the unit. Failure to do so voids warranty.

WARNING

Compressor warranties are void if compressor burns out due to low voltage.

WARNING

Power supply cord ground should not be removed!

WARNING

Do not use electrical appliances inside the food storage compartments of the appliances unless they are of the type recommended by the manufacturer.

NOTE

To reference wiring diagram - Remove front louvered grill, wiring diagram is positioned on the inside cabinet wall.

INSTALLATION / OPERATION INSTRUCTIONS

CONDUCTORS AND CIRCUITS

Wire Gauge for 2% Voltage Drop in Supply Circuits

115 Volt Amps	Distance In Feet To Center of Load											
	20	30	40	50	60	70	80	90	100	120	140	160
2	14	14	14	14	14	14	14	14	14	14	14	14
3	14	14	14	14	14	14	14	14	14	14	14	14
4	14	14	14	14	14	14	14	14	14	12	12	12
5	14	14	14	14	14	14	14	12	12	12	10	10
6	14	14	14	14	14	14	12	12	12	10	10	10
7	14	14	14	14	14	12	12	12	10	10	10	8
8	14	14	14	14	12	12	12	10	10	10	8	8
9	14	14	14	12	12	12	10	10	10	8	8	8
10	14	14	14	12	12	10	10	10	10	8	8	8
12	14	14	12	12	10	10	10	8	8	8	8	6
14	14	14	12	10	10	10	8	8	8	6	6	6
16	14	12	12	10	10	8	8	8	8	6	6	6
18	14	12	10	10	8	8	8	8	8	8	8	5
20	14	12	10	10	8	8	8	6	6	6	5	5
25	12	10	10	8	8	6	6	6	6	5	4	4
30	12	10	8	8	6	6	6	6	5	4	4	3
35	10	10	8	6	6	6	5	5	4	4	3	2
40	10	8	8	6	6	5	5	4	4	3	2	2
45	10	8	6	6	6	5	4	4	3	3	2	1
50	10	8	6	6	5	4	4	3	3	2	1	1

Wire Gauge for 2% Voltage Drop in Supply Circuits

230 Volts Amps	Distance In Feet To Center of Load											
	20	30	40	50	60	70	80	90	100	120	140	160
5	14	14	14	14	14	14	14	14	14	14	14	14
6	14	14	14	14	14	14	14	14	14	14	14	14
7	14	14	14	14	14	14	14	14	14	14	14	14
8	14	14	14	14	14	14	14	14	14	12	12	12
9	14	14	14	14	14	14	14	14	14	12	12	10
10	14	14	14	14	14	14	14	12	12	12	10	10
12	14	14	14	14	14	14	12	12	12	10	10	10
14	14	14	14	14	14	12	12	12	10	10	10	8
16	14	14	14	14	12	12	12	10	10	10	8	8
18	14	14	14	12	12	12	10	10	10	8	8	8
20	14	14	14	12	10	10	10	10	10	8	8	8
25	14	14	12	12	10	10	10	10	8	8	6	6
30	14	12	12	10	10	10	8	8	8	6	6	6
35	14	12	10	10	10	8	8	8	8	6	6	5
40	14	12	10	10	8	8	8	6	6	6	5	5
50	12	10	10	8	6	6	6	6	6	5	4	4
60	12	10	8	6	6	6	6	6	5	4	4	3
70	10	10	8	6	6	6	5	5	4	4	2	2
80	10	8	8	6	6	5	5	4	4	3	2	2
90	10	8	6	6	5	5	4	4	3	3	1	1
100	10	8	6	6	5	4	4	3	3	2	1	1

INSTALLATION / OPERATION INSTRUCTIONS

STARTUP

- A.** The compressor is ready to operate. Plug in the cooler.
- B.** Temperature control set at No. 4 position gives refrigerators an approximate temperature of 35°F. Allow unit to function several hours, completely cooling cabinet before changing the control setting.
- C.** Excessive tampering with the control could lead to service difficulties. Should it ever become necessary to replace temperature control, be sure it is ordered from your TRUE dealer or recommended service agent.
- D.** Good air flow in your TRUE unit is critical. Be careful to load product so that it neither presses against the back wall, nor comes within four inches of the evaporator housing. Refrigerated air off the coil must circulate down the back wall.

NOTE

If the cooler is disconnected or shut off, wait five minutes before starting again.

RECOMMENDATION

Before loading product we recommend you run your TRUE unit empty for two to three days. This allows you to be sure electrical wiring and installation are correct and no shipping damage has occurred. Remember, our factory warranty does not cover product loss!

REPLACEMENT PARTS

TRUE maintains a record of the cabinet serial number for your cooler. If at any time during the life of your cooler, a part is needed, you may obtain this part by furnishing the model number and serial number to the company from whom you purchased the cooler. Call Toll-Free: (800)-424-TRUE (Direct to Parts Department). (800)-325-6152 (U.S.A. & Canada only) or call: (636)-240-2400.

AIR-FLOW THROUGHOUT CABINET (TPP UNITS ONLY!)

WARNING

REMOVAL OF BAFFLES IN CONDIMENT PAN AREA WILL ADVERSELY AFFECT REFRIGERATION PERFORMANCE. PLEASE LEAVE THE BAFFLES IN THE CORRECT LOCATION. (See images below)

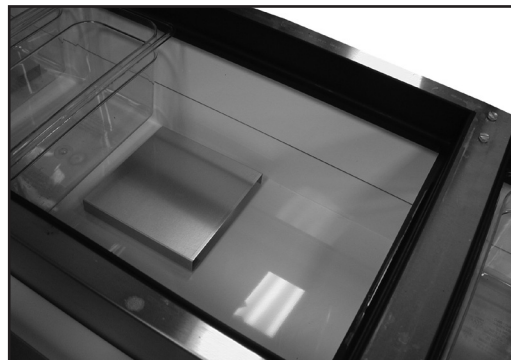
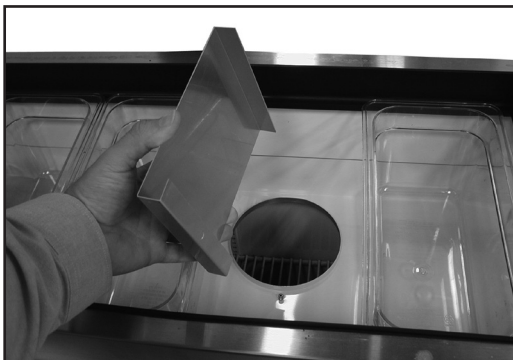

Baffle in the correct location.

INSTALLATION / OPERATION INSTRUCTIONS

TEMPERATURE CONTROL LOCATION AND SETTING - TFP UNITS ONLY

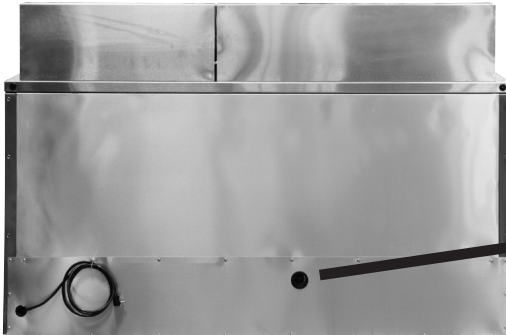

TFP Temperature control is located on the back of the unit.

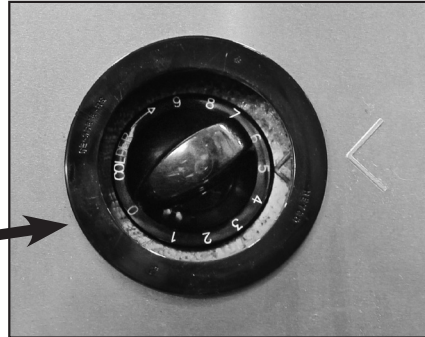

Set control to 5.

TEMPERATURE CONTROL ADJUSTMENT FOR HIGH ALTITUDE ONLY!

TERMS

Cut-out - Temperature sensed by the controller that shuts the compressor off.

Cut-in - Temperature sensed by the controller that turns the compressor on.

REQUIRED TOOLS

- Phillips Head Screwdriver
- 5/64" or 2 mm Allen Wrench
- T-7 Torx Wrench

STEP 1

Unplug the cooler.

NOTE

Mechanical temperature controllers are affected when functioning at high altitude. The cut-in and cut-out temperatures will be colder than when the controller functions closer to sea level.

STEP 2

Remove the screws that secure the temperature control to the inset box lower left side of the cabinet (when facing the front of the cabinet).

STEP 3

Pull out gently from cabinet.

STEP 4

For high elevation installations, it may be necessary to "warm-up" the

set points. To make the adjustment, insert the appropriate tool in each adjustment screw and turn 1/4 of a revolution clockwise (to the right). This procedure will adjust both the cut-in and cut-out about 2°F warmer.

STEP 5

Make sure to reconnect the pink wire to the proper spade terminal when reinstalling.

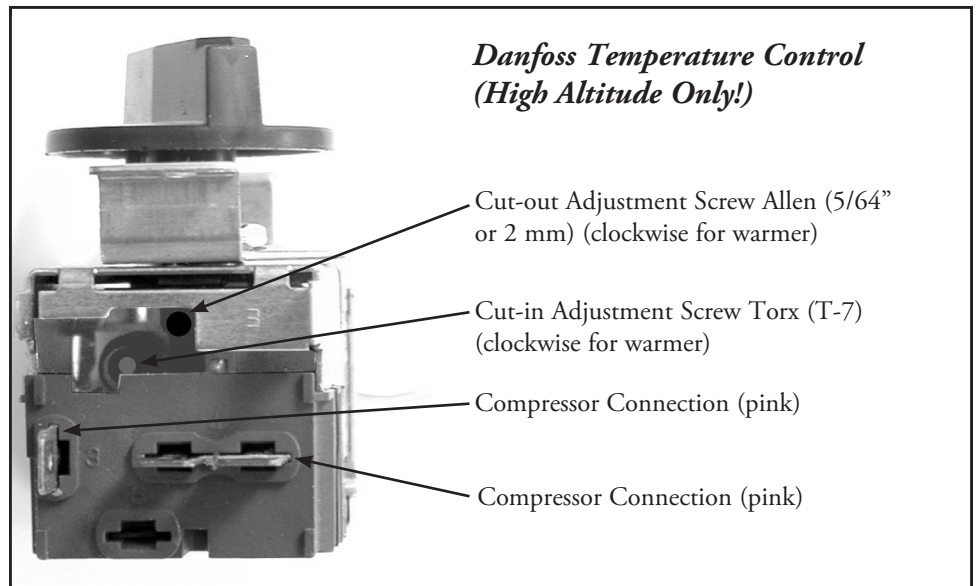

TUC-24-HC and TUC-24G-HC Only



DISPLAY

DISPLAY	
<i>dEF</i> Defrost in progress	<i>h_i</i> Room high temperature alarm
<i>oFF</i> Controller in stand-by	<i>L_o</i> Room low temperature alarm
<i>do</i> Door open alarm	<i>E₁</i> Probe T1 failure
<i>t₁</i> Instant probe 1 temperature	<i>E₂</i> Probe T2 failure
<i>t₂</i> Instant probe 2 temperature	<i>E₃</i> Probe T3 failure
<i>t₃</i> Instant probe 3 temperature	<i>t_{h₁}</i> Maximum probe 1 temperature recorded
<i>n_{in}</i> Minutes of the Real Time Clock	<i>t_{L_o}</i> Minimum probe 1 temperature recorded
<i>hr₅</i> Hours of the Real Time Clock	<i>L_{oc}</i> Keypad state lock

LAE CONTROL SEQUENCE OF OPERATION

1. Cabinet is plugged in.
 - a. Display will illuminate.
 - b. Interior light will illuminate on glass door models only. (If lights do not come on please see instructions on following page(s).) Solid door cabinet lights are controlled by door switch.
2. After the LAE control preprogrammed time delay of 3 minutes, the compressor and evaporator fan(s) will start if the control is calling for cooling.
 - a. Control may be already pre-programmed from the factory so at the start of every compressor cycle or during a defrost cycle, the condenser fan(s) will reverse for 30 seconds to blow dirt off the condensing coil.
3. The LAE control will cycle the compressor but may also cycle evaporator fan(s) on and off determined by the Set-Point and Differential temperatures. (If the Set-Point needs to be changed due to conditions please see instructions on the following page(s).)
 - a. The **Set-Point** is the preprogrammed temperature which shuts off the compressor.
 - b. The **Differential** is the preprogrammed temperature that is added to the Set-Point temperature that will start the compressor.

Example: If the Set-Point is -9°F/-23°C and the Differential is 10°F/5°C

(Set-Point) -9°F + 10 (Differential) = 1°F

Or

(Set-Point) -23°C + 5 (Differential) = -18°C

The compressor and evaporator fan(s) will cycle off -9°F/-23°C
and back on at 1°F/-18°C

4. The LAE control may be preprogrammed to initiate defrost by interval or at specific times of day. (If additional Defrost Intervals or Cycles are needed or a Manual Defrost is required due to conditions please see instructions on the following page(s).)
 - a. At this time the “dEF” will appear on the display and compressor will turn off until a preprogrammed temperature or duration is reached. During this time for freezers only, evaporator fan(s) will also turn off and the coil heater and drain tube heaters will also be energized.
 - b. After the preprogrammed temperature or duration for defrost has been reached there may be a short delay for both the compressor and evaporator fans to restart. At this time “dEF” may still appear on the display for a short time.

True Manufacturing recommends that ONLY the Set-Point and/or Defrost Interval may be adjusted due to certain conditions.

This sequence is NOT model specific.

If you have any questions, please contact the Technical Service Department.

Phone: 800-325-6152 • Email: service@truemfg.com

..... www.truemfg.com

LAE Electronic Control



LAE Control Icons	
	Compressor Running
	Evaporator Fan Running
	Cabinet in Defrost
	Activation of 2nd Parameter Set - NA
	Alarm - NA



Info/Set Point Button



Manual Defrost/Down Button



Manual Activation/Up Button



Stand-By Button

LOCKING & UNLOCKING LAE CONTROLLER

WHY:

LOCKING OF CONTROL IS NECESSARY TO PREVENT CHANGES TO PROGRAM THAT MAY AFFECT CABINET OPERATION

HOW:

- A.** To change lock setting press and release the info button . "t1" will appear. See image 1.
Press the up button until "Loc" appears. See image 2.
- B.** While pressing and holding the info button press the up or down button to change the lock settings. If "no" appears, the controller is unlocked. If "yes" appears, the controller is locked. See images 3 and 4.
- C.** Once the lock setting has been set correctly release the info button .
Wait 5 seconds for the display to show temperature. See image 5.



Image 3:
If "no" appears on screen, the controller is unlocked.



Image 4:
If "yes" appears on screen, the controller is locked.



LAE Electronic Control



LAE Control Icons	
	Compressor Running
	Evaporator Fan Running
	Cabinet in Defrost
	Activation of 2nd Parameter Set - NA
	Alarm - NA



Info/Set Point Button



Manual Defrost/Down Button



Manual Activation/Up Button



Stand-By Button

HOW TO TURN GLASS DOOR MODEL LIGHTS ON/OFF

May need to unlock control.

WHY:

LIGHT MAY BE CONTROLLED BY LAE CONTROLLER OR INTERIOR LIGHT SWITCH.

HOW:

- A.** To control interior/sign lights by the LAE Controller, press and release the “Manual Activation”  button.
- B.** To control interior/sign lights by the interior door switch, depress the rocker switch to the “ON” position. Light Switch is located on inside top right of the ceiling.

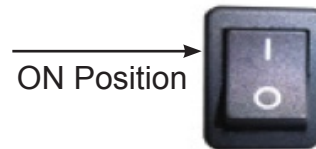

(Solid Door models lights are controlled by a door switch)

LAE Electronic Control



LAE Control Icons	
	Compressor Running
	Evaporator Fan Running
	Cabinet in Defrost
	Activation of 2nd Parameter Set - NA
	Alarm - NA



Info/Set Point Button



Manual Defrost/Down Button



Manual Activation/Up Button

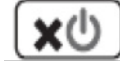

Stand-By Button

HOW TO CHANGE THE "SET POINT"





May need to unlock control.

WHY:

THE SET POINT IS THE TEMPERATURE AT WHICH THE COMPRESSOR WILL SHUT OFF.

Please note that the "set point" IS NOT the cabinet holding temperature.

HOW:

- A.** To see the set point, press and hold the info button. See image 1.
- B.** While still holding the info button , press the up  or down  button to change the "set point".
- C.** Once the "set point" has been set correctly release the info button . The display will show temperature. See image 2.



LAE Electronic Control



LAE Control Icons	
	Compressor Running
	Evaporator Fan Running
	Cabinet in Defrost
	Activation of 2nd Parameter Set - NA
	Alarm - NA



Info/Set Point Button



Manual Defrost/Down Button



Manual Activation/Up Button



Stand-By Button

HOW TO INITIATE A MANUAL DEFROST

May need to unlock control.

WHY:

A ONE TIME ADDITIONAL DEFROST MAY BE NECESSARY TO CLEAR ACCUMULATED FROST/ICE FROM EVAPORATOR COIL.

HOW:

The method to initiate a manual defrost is determined by the Defrost Mode Parameter “DTM” preprogrammed in the controller.

A. REGULAR TIME DEFROST (TIM)

If controller is preprogrammed for “TIM”, press and release the Manual Defrost button until “dEF” appears.

B. REAL TIME CLOCK (RTC)

If controller is preprogrammed for “RTC” press the and hold the Manual Defrost button for 5 seconds until “dh1” appears. Release the Manual Defrost button and then press and hold for an additional 5 seconds until “dEF” appears.

DEFROST WILL ONLY TERMINATE ONCE A SPECIFIC PRESET TEMPERATURE OR A PRESET TIME DURATION IS REACHED.

LAE Electronic Control

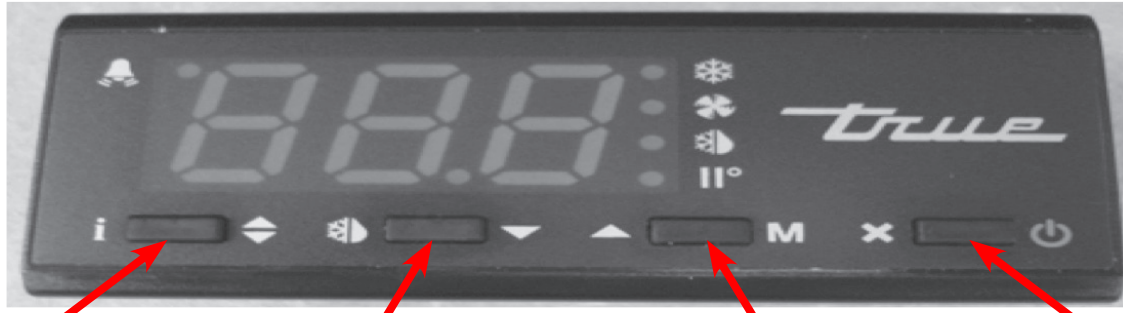

LAE Control Icons	
	Compressor Running
	Evaporator Fan Running
	Cabinet in Defrost
	Activation of 2nd Parameter Set - NA
	Alarm - NA



Info/Set Point Button



Manual Defrost/Down Button



Manual Activation/Up Button



Stand-By Button

HOW TO CHANGE “DEFROST INTERVALS”

May need to unlock control.

This can only be changed if defrost mode parameter “DFM” is set for “TIM”.

WHY:

THE DEFROST INTERVAL IS THE TIME DURATION BETWEEN DEFROST CYCLES.

The Defrost Interval time starts when the cabinet is supplied power or after a manual defrost.

HOW:

- A.** To see the set point, press and hold the info button and the stand-by button at the same time. “ScL” will appear. See image 1.
- B.** Push the up button until “dFt” appears. See image 2.
- C.** Press and hold the info button to see the “defrost interval time”. See image 3.
- D.** While pressing and holding the info button , press the up or down button to change the “defrost interval times” (higher the number the less frequent the cabinet will defrost).
- E.** Once the “defrost interval time” has been changed, release the info button .
Wait 30 seconds for the display to show temperature. See image 4.



INSTALLATION / OPERATION INSTRUCTIONS

TSSU-27-12M-C CHILLER HOSE

Required Tools:

- Slotted screwdriver
- Needle nose pliers
- Hex-head nut driver

Kit Components:

- Hose Cleaning Brush

WARNING

Power must be disconnected before beginning this procedure.

1. Remove the condiment pans.



2. Remove the shelving from the unit.



3. Using needle-nosed pliers remove the right or left pilaster as needed. (This will provide clearance to pull right or left housing away from evaporator).



4. Using a hex-head nut remover, remove right or left C-clamps as needed from chiller hose. (Remove clamps from both ends of the assembly).



5. Back off four slotted thumb screws and remove evaporator housing.

IMPORTANT

Note the proper position of the flexible tubing on top of evaporator. (See Fig. 6). Hose will need to be repositioned in the same area to ensure proper conditioned air circulation.



6. Gently pull housing from the right or left side and work forward in order to access the flexible hose.

CAUTION

Gloves are recommended to avoid contact with possible sharp edges.

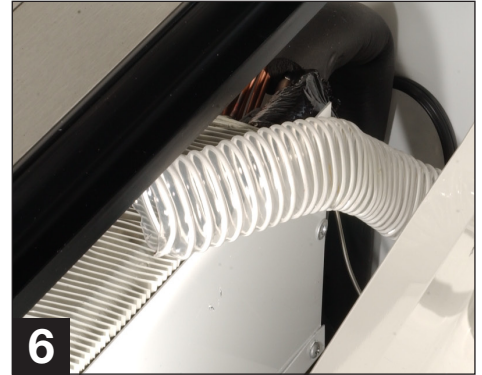

7. Rout the bottle brush through the rear of the flexible hose and push contents forward.

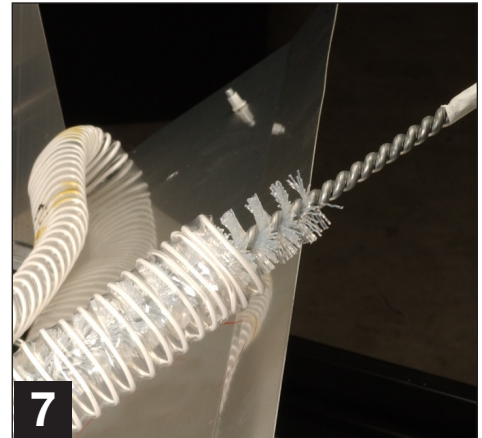

8. Reverse the procedures as outlined above.

NOTE

Replace flexible hose in the original position as indicated in Fig. 6. Failure to replace properly will result in compromised unit operation.

INSTALLATION / OPERATION INSTRUCTIONS

SHELVING INSTALLATION / OPERATION & LIGHT SWITCH LOCATION

WARNING

Do not use pliers or any crimping tools when installing shelf clips. Altering shelf clips in any way can lead to shelving instability.

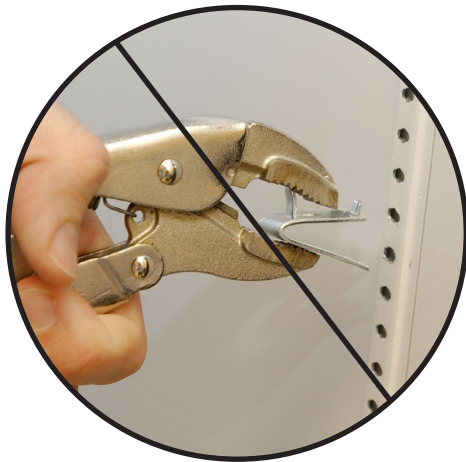

For Proper Shelf Clip Installation Please Read The Following Instructions.

Step 1

Shelf clips are to be installed into the shelf standards next to the labels on the interior cabinet wall. This label can be seen in images 1-4. Install the top tab of the shelf clip into the proper hole. Push up on the bottom of the clip. (See image 1).

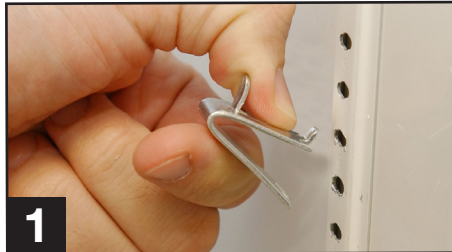

1 (Installing top tab of shelf clip)

Step 2

Bottom tab of the shelf clip will fit tightly. You may need to squeeze or twist the bottom of the shelf clip to install. (See image 2 & 3).

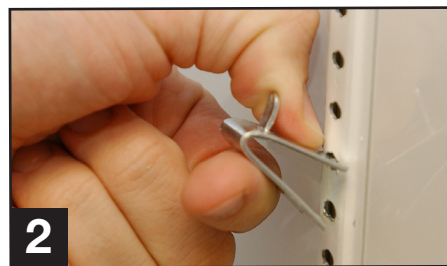

2 (Installing bottom of the shelf clip)



3 (You may need to squeeze or twist the bottom of the shelf clip to install)



4 (Shelf clip installation complete)

Step 3

After installation, the shelf clip will fit snug into the shelf standard. The shelf clip should not be loose or able to wiggle out of the shelf standard.

Shelf Installation Tips

1. Install all the shelf clips before installing the shelves.
2. Start at the bottom in terms of shelf installation and work your way up.
3. Always lay the back of each shelf down on the rear clips before the front.

SHELF INSTALLATION:

Step 1

- A. Hook shelf clips onto shelf standards. (see illustration).
- B. Position all four shelf clips equal in distance from the floor for flat shelves.

WIRE SHELVES:

Wire shelves are oriented so that cross support bars are facing down.

Step 2

Place shelves on shelf clips making sure all corners are seated properly.

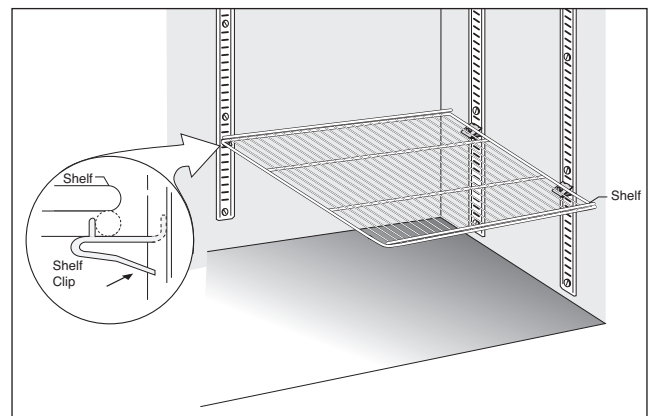

LIGHT SWITCH LOCATION:

Light switch location depends upon the TUC & TWT glass door model. Most models will have the light switch located inside the unit above the door. Most instances the switch is located next to the light on the ceiling.

INSTALLATION / OPERATION INSTRUCTIONS

TFP DRAWER REMOVAL AND INSTALLATION

Removal

- A. Open drawer completely. Roller clips will be in the down position. (see image 1 & 2)
- B. While holding the sides of the drawer, use your finger to rotate the clips upward. (see image 3)
- C. Lift drawer and remove from channel. (see image 4)

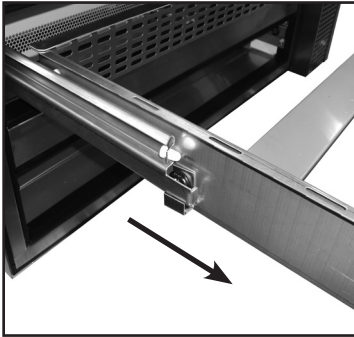

Image 1

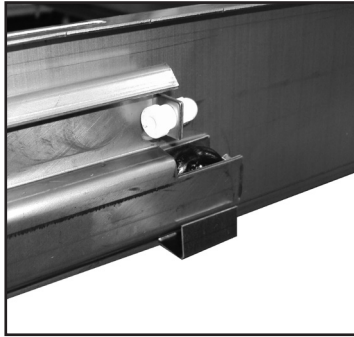

Image 2

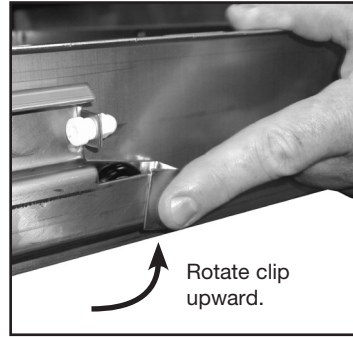

Image 3



Image 4

Installation

- A. Lower rear rollers into channel slots. (see image 1)
- B. With the roller clips in the upward position, lower front rollers into channel. (see image 2)
- C. Make sure roller clips are in the down position. (see image 3)

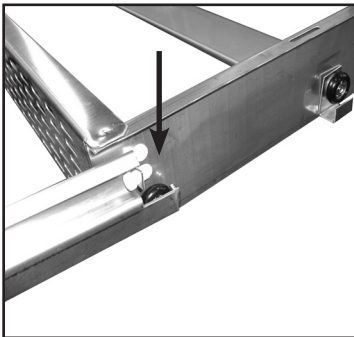

Image 1

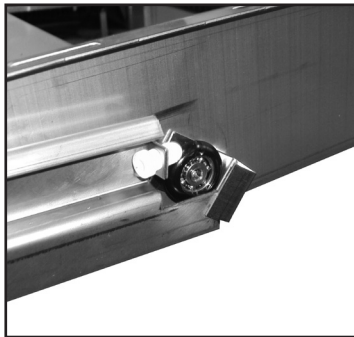

Image 2

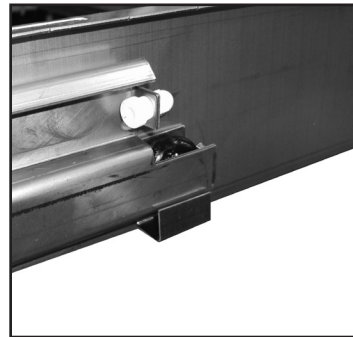

Image 3

MAINTENANCE, CARE & CLEANING

MAINTENANCE, CARE & CLEANING

CLEANING THE CONDENSER COIL

When using electrical appliances, basic safety precautions should be followed, including the following:

REQUIRED TOOLS:

- Phillips Screwdriver
- Stiff Bristle Brush
- Adjustable Wrench
- Vacuum Cleaner

Step 1

Disconnect power to unit.

Step 2

Remove the rear grill by backing out two screws.

(See image 3).

Step 3

Remove bolts anchoring compressor assembly to frame rails and carefully slide out. (tube connections are flexible)

Step 4

Clean off accumulated dirt from the condenser coil and the fan with a stiff bristle brush. (See image 1).

Step 5

Lift cardboard cover above fan at plastic plugs and carefully clean condenser coil and fan blades.

Step 6

After brushing condenser coil vacuum dirt from coil, and interior floor. (See image 2)

Step 7

Replace cardboard cover. Carefully slide compressor assembly back into position and replace bolts.

Step 8

Reinstall rear grill assembly onto unit. Tighten all screws.

Step 9

Connect unit to power and check to see if compressor is running.

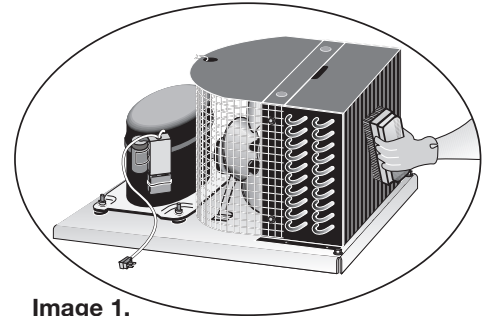

Image 1.

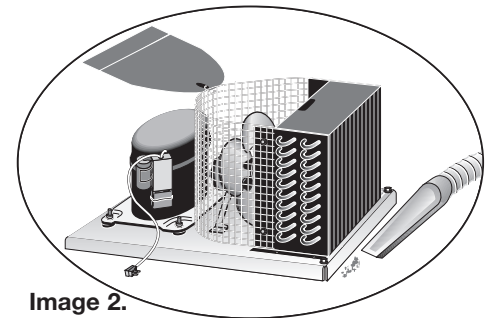

Image 2.

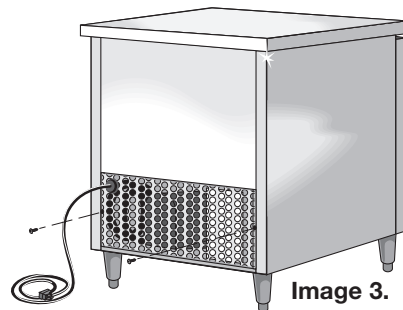

Image 3.

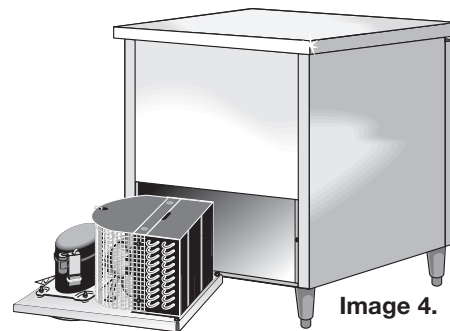

Image 4.

IMPORTANT WARRANTY INFORMATION

Condensers accumulate dirt and require cleaning every 30 days. Dirty condensers result in compressor failure, product loss, and lost sales... which are not covered by warranty.

If you keep the Condenser clean you will minimize your service expense and lower your electrical costs. The Condenser requires scheduled cleaning every thirty days or as needed.

Air is pulled through the Condenser continuously, along with dust, lint, grease, etc.

A dirty Condenser can result in NON-WARRANTED part & Compressor Failures, Product Loss, and Lost Sales.

Proper cleaning involves removing dust from the Condenser. By using a soft brush, or vacuuming the Condenser with a shop vac, or using CO2, nitrogen, or pressurized air.

If you cannot remove the dirt adequately, please call your refrigeration service company.

The Condenser looks like a group of vertical fins. You need to be able to see through the condenser for the unit to function at maximum capacity. Do not place filter material in front of condensing coil. This material blocks air-flow to the coil similar to having a dirty coil.

THE CLEANING OF THE CONDENSER IS NOT COVERED BY THE WARRANTY!

HOW TO CLEAN THE CONDENSER:

1. Disconnect the electrical power to the unit.
2. Remove the louvered grill.
3. Vacuum or brush the dirt, lint, or debris from the finned condenser coil.
4. If you have a significant dirt build up you can blow out the condenser with compressed air. (CAUTION MUST BE USED to avoid eye injury. Eye protection is recommended.)
5. When finished be sure to replace the louvered grill. The grill protects the condenser.
6. Reconnect the electrical power to the unit.

If you have any questions, please call TRUE Manufacturing at 636-240-2400 or 800-325-6152 and ask for the Service Department. Service Department Availability Monday-Thursday 7:00 a.m. to 7:00 p.m., Thursday 7:00 a.m. to 6:00 p.m. and Saturday 8:00 a.m. to 12:00 p.m. CST.

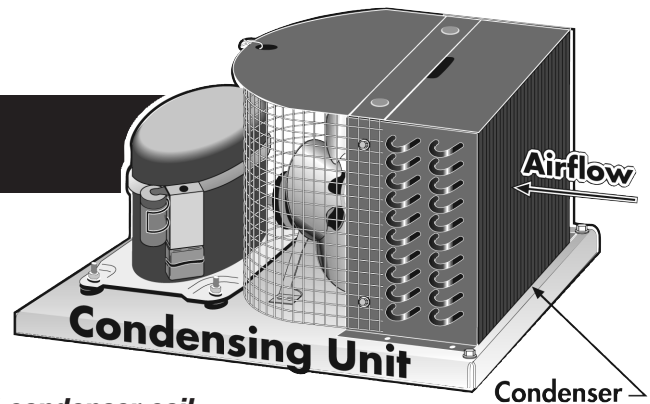

MAINTENANCE, CARE & CLEANING

Stainless Steel Equipment Care and Cleaning

CAUTION: Do not use any steel wool, abrasive or chlorine based products to clean stainless steel surfaces.

• Stainless Steel Opponents

There are three basic things which can break down your stainless steel's passivity layer and allow corrosion to rear its ugly head.

- 1) Scratches from wire brushes, scrapers, and steel pads are just a few examples of items that can be abrasive to stainless steel's surface.
- 2) Deposits left on your stainless steel can leave spots. You may have hard or soft water depending on what part of the country you live in. Hard water can leave spots. Hard water that is heated can leave deposits if left to sit too long. These deposits can cause the passive layer to break down and rust your stainless steel. All deposits left from food prep or service should be removed as soon as possible.
- 3) Chlorides are present in table salt, food, and water. Household and industrial cleaners are the worst type of chlorides to use.

8 steps that can help prevent rust on stainless steel:

1. Using the correct cleaning tools
Use non-abrasive tools when cleaning your stainless steel products. The stainless steel's passive layer will not be harmed by soft cloths and plastic scouring pads. Step 2 tells you how to find the polishing marks.
2. Cleaning along the polish lines
Polishing lines or "grain" are visible on some stainless steels. Always scrub parallel to visible lines on some stainless steels. Use a plastic scouring pad or soft cloth when you cannot see the grain.
3. Use alkaline, alkaline chlorinated or non-chloride containing cleaners
While many traditional cleaners are loaded with chlorides, the industry is providing an ever increasing choice of non-chloride cleaners. If you are not sure of your cleaner's chloride content contact your cleaner supplier. If they tell you that your present cleaner contains chlorides, ask if they have an alternative. Avoid cleaners containing quaternary salts as they can attack stainless steel, causing pitting and rusting.
4. Water Treatment
To reduce deposits, soften the hard water when possible. Installation of certain filters can remove corrosive and distasteful elements. Salts in a properly maintained water softener can be to your advantage. Contact a treatment specialist if you are not sure of the proper water treatment.
5. Maintaining the cleanliness of your food equipment
Use cleaners at recommended strength (alkaline, alkaline chlorinated or non-chloride). Avoid build-up of hard stains by cleaning frequently. When boiling water with your stainless steel equipment, the single most likely cause of damage is chlorides in the water. Heating any cleaners containing chlorides will have the same damaging effects.
6. Rinse
When using chlorinated cleaners you must rinse and wipe dry immediately. It is better to wipe standing cleaning agents and water as soon as possible. Allow the stainless steel equipment to air dry. Oxygen helps maintain the passivity film on stainless steel.
7. Hydrochloric acid (muriatic acid) should never be used on stainless steel
8. Regularly restore/passivate stainless steel

MAINTENANCE, CARE & CLEANING

Stainless Steel Equipment Care and Cleaning

Recommended cleaners for certain situations / environments of stainless steel

- A) Soap, ammonia and detergent medallion applied with a cloth or sponge can be used for routine cleaning.
- B) Arcal 20, Lac-O-Nu Ecoshine applied provides barrier film for fingerprints and smears.
- C) Cameo, Talc, Zud First Impression is applied by rubbing in the direction of the polished lines for stubborn stains and discoloring.
- D) Easy-off and De-Grease It oven aid are excellent for removals on all finishes for grease-fatty acids, blood and burnt-on foods.
- E) Any good commercial detergent can be applied with a sponge or cloth to remove grease and oil.
- F) Benefit, Super Sheen, Sheila Shine are good for restoration / passivation.

NOTE

The use of stainless steel cleaners or other such solvents is not recommended on plastic parts. Warm soap and water will suffice.

Composite Cutting Board Maintenance

Please see comments from Supplier regarding composite cutting boards below.

RE: Composite Cutting Boards Manufactured From Richlite Material and Warping.

“To prevent warping on cutting boards manufactured from Richlite® material, simply turn the board over on a regular scheduled basis. Warping is caused by continued moisture and temperature differences on the top and bottom of the boards. By turning the board over, this will allow both sides of the board to receive the same exposure.

There is a chance that larger size boards may warp as a characteristic of the material.”

MAINTENANCE, CARE & CLEANING

Periodic Maintenance for Lids

NOTE

Because lid pin screws are designed to be removable for cleaning, it is important these are checked periodically to assure they are tight.

Step 1

Check to see if lid assembly thumbscrews are tight.
See Image 1.

Step 2

Use slotted screwdriver to tighten thumbscrews into place.
See Image 2.

Step 3

Make sure that thumbscrews are secure.

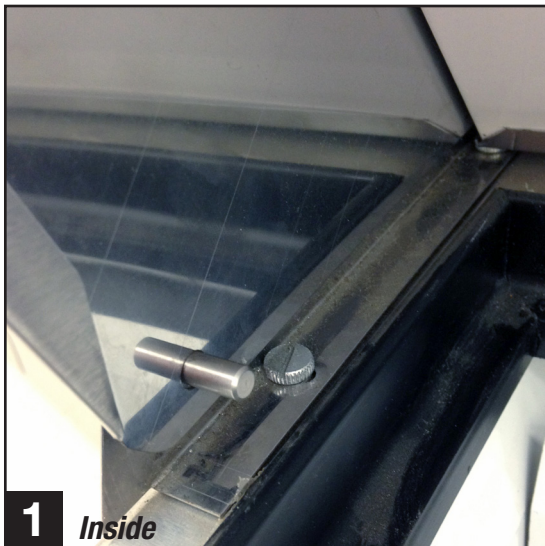

WARRANTY INFORMATION (U.S.A & CANADA ONLY!)

**THIS WARRANTY ONLY APPLIES TO UNITS SHIPPED FROM TRUE'S MANUFACTURING FACILITIES AFTER JANUARY 1, 2013.
PRODUCT MUST BE PURCHASED IN THE COUNTRY WHERE SERVICE IS REQUESTED.**

THREE YEAR PARTS & LABOR WARRANTY

TRUE warrants to the original purchaser of every new TRUE refrigerated unit, the cabinet and all parts thereof, to be free from defects in material or workmanship, under normal and proper use and maintenance service as specified by TRUE and upon proper installation and start-up in accordance with the instruction packet supplied with each TRUE unit. TRUE's obligation under this warranty is limited to a period of three (3) years from the date of original installation or 39 months after shipment date from TRUE, whichever occurs first.

Any part covered under this warranty that are determined by TRUE to have been defective within three (3) years of original installation or thirty-nine (39) months after shipment date from manufacturer, whichever occurs first, is limited to the repair or replacement, including labor charges, of defective parts or assemblies. The labor warranty shall include standard straight time labor charges only and reasonable travel time, as determined by TRUE.

Warranty does not cover standard wear parts which include door gaskets, incandescent bulbs or fluorescent bulbs. Warranty also does not cover issues caused by improper installation or lack of basic preventative maintenance which includes regular cleaning of condenser coils.

ADDITIONAL TWO YEAR COMPRESSOR WARRANTY

In addition to the Three (3) year warranty stated above, TRUE warrants its hermetically and semi-hermetically sealed compressor to be free from defects in both material and workmanship under normal and proper use and maintenance service for a period of two (2) additional years from the date of original installation but not to exceed five (5) years and three (3) months after shipment from the manufacturer.

Compressors determined by TRUE to have been defective within this extended time period will, at TRUE's option, be either repaired or replaced with a compressor or compressor parts of similar design and capacity.

The two (2) year extended compressor warranty applies only to hermetically and semi-hermetically sealed parts of the compressor and does not apply to any other parts or components, including, but not limited to: cabinet, paint finish, temperature control, refrigerant, metering device, driers, motor starting equipment, fan assembly or any other electrical component, etcetera.

404A/134A COMPRESSOR WARRANTY

The two year compressor warranty detailed above will be voided if the following procedure is not carefully adhered to:

1. This system contains R404A or R134A refrigerant and polyol ester lubricant. The polyol ester lubricant has rapid moisture absorbing qualities. If long exposure to the ambient conditions occur, the lubricant must be removed and replaced with new. For oil amounts and specifications please call TRUE technical service department (800-325-6152). Failure to comply with recommended lubricant specification will void the compressor warranty.

2. Drier replacement is very important and must be changed when a system is opened for servicing. A drier using XH-7 desiccant or an exact replacement solid core drier must be used. The new drier must also be the same capacity as the drier being replaced.

3. Micron level vacuums must be achieved to insure low moisture levels in the system. 500 microns or lower must be obtained.

WARRANTY CLAIMS

All claims for labor or parts must be made directly through TRUE. All claims should include: model number of the unit, the serial number of the cabinet, proof of purchase, date of installation, and all pertinent information supporting the existence of the alleged defect.

In case of warranty compressor, the compressor model tag must be returned to TRUE along with above listed information.

Any action or breach of these warranty provisions must be commenced within one (1) year after that cause of action has occurred.

WHAT IS NOT COVERED BY THIS WARRANTY

TRUE's sole obligation under this warranty is limited to either repair or replacement of parts, subject to the additional limitations below. This warranty neither assumes nor authorizes any person to assume obligations other than those expressly covered by this warranty.

NO CONSEQUENTIAL DAMAGES. TRUE IS NOT RESPONSIBLE FOR ECONOMIC LOSS; PROFIT LOSS; OR SPECIAL, INDIRECT, OR CONSEQUENTIAL DAMAGES, INCLUDING WITHOUT LIMITATION, LOSSES OR DAMAGES ARISING FROM FOOD OR PRODUCT SPOILAGE CLAIMS WHETHER OR NOT ON ACCOUNT OF REFRIGERATION FAILURE.

WARRANTY IS NOT TRANSFERABLE. This warranty is not assignable and applies only in favor of the original purchaser/user to whom delivered. ANY SUCH ASSIGNMENT OR TRANSFER SHALL VOID THE WARRANTIES HEREIN MADE AND SHALL VOID ALL WARRANTIES, EXPRESS OR IMPLIED, INCLUDING ANY WARRANTY OF MERCHANTABILITY OR FITNESS FOR A PARTICULAR PURPOSE.

IMPROPER USAGE. TRUE ASSUMES NO LIABILITY FOR PARTS OR LABOR COVERAGE FOR COMPONENT FAILURE OR OTHER DAMAGES RESULTING FROM IMPROPER USAGE OR INSTALLATION OR FAILURE TO CLEAN AND/OR MAINTAIN PRODUCT AS SET FORTH IN THE WARRANTY PACKET PROVIDED WITH THE UNIT.

RESIDENTIAL APPLICATIONS: TRUE assumes no liability for parts or labor coverage for component failure or other damages resulting from installation in non-commercial or residential applications.

ALTERATION, NEGLIGENCE, ABUSE, MISUSE, ACCIDENT, DAMAGE DURING TRANSIT OR INSTALLATION, FIRE, FLOOD, ACTS OF GOD. TRUE is not responsible for the repair or replacement of any parts that TRUE determines have been subjected after the date of manufacture to alteration, neglect, abuse, misuse, accident, damage during transit or installation, fire, flood, or act of God.

IMPROPER ELECTRICAL CONNECTIONS. TRUE IS NOT RESPONSIBLE FOR THE REPAIR OR REPLACEMENT OF FAILED OR DAMAGED COMPONENTS RESULTING FROM INCORRECT SUPPLY VOLTAGE, THE USE OF EXTENSION CORDS, LOW VOLTAGE, OR UNSTABLE SUPPLY VOLTAGE.

NO IMPLIED WARRANTY OF MERCHANTABILITY OR FITNESS FOR A PARTICULAR PURPOSE: THERE ARE NO OTHER WARRANTIES, EXPRESSED, IMPLIED OR STATUTORY, EXCEPT THE THREE (3) YEAR PARTS & LABOR WARRANTY AND THE ADDITIONAL TWO (2) YEAR COMPRESSOR WARRANTY AS DESCRIBED ABOVE. THESE WARRANTIES ARE EXCLUSIVE AND IN LIEU OF ALL OTHER WARRANTIES, INCLUDING IMPLIED WARRANTY AND MERCHANTABILITY OR FITNESS FOR A PARTICULAR PURPOSE. THERE ARE NO WARRANTIES WHICH EXTEND BEYOND THE DESCRIPTION ON THE FACE HEREOF.

OUTSIDE U.S./CANADA: This warranty does not apply to, and TRUE is not responsible for, any warranty claims made on products sold or used outside the United States or Canada.