

SPECIFICATION DWG

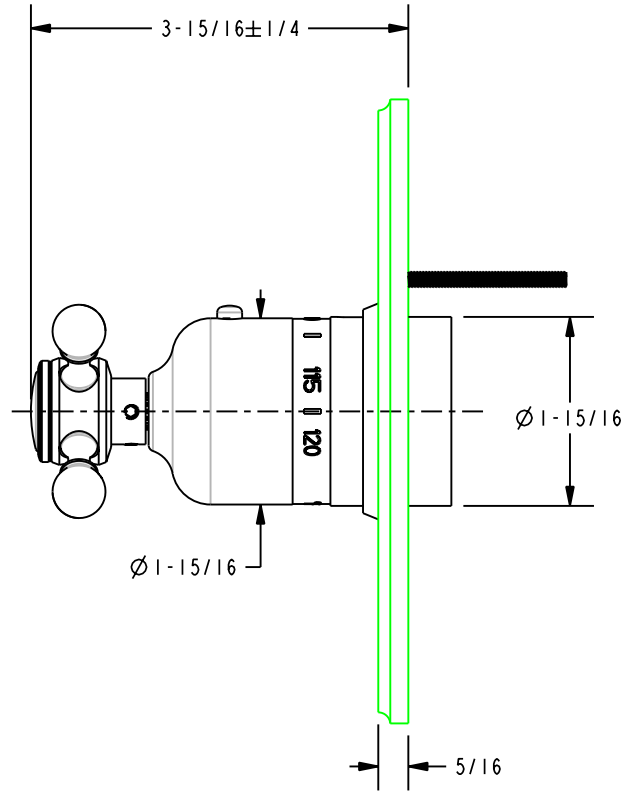
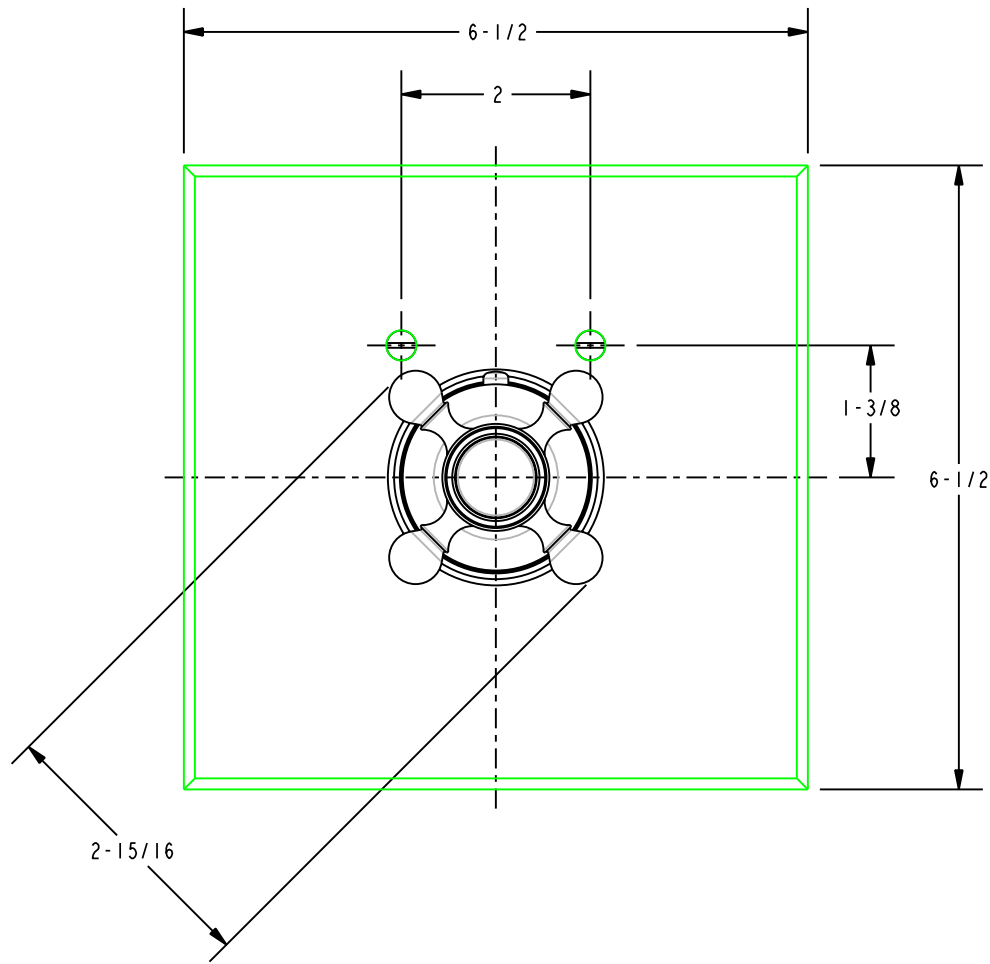

DIMENSIONS ARE IN INCHES AND AN APPROXIMATION OF A TYPICAL INSTALLATION

BRASSTECH INCORPORATED
 2001 E. CARNEGIE AVE.
 SANTA ANA, CA 92705
 (949) 417-5207

SQUARE TRIM THERMO

ASSY. NO. **3-924TS_SPEC**

SCALE 0.500

REF. -

SHEET 1 OF 1

COPYRIGHT ©

A	EO-0078	09/16/02
-	RELEASED	03/01/01
REV	REV DESC	DATE