

Features

- Fits minimum 21-inch base cabinet if installed as top-mount.
- Fits minimum 24-inch base cabinet if installed as under-mount.
- Single bowl.
- 12-1/2-inch depth.
- 1 faucet hole (-1).
- Includes cutout templates.

Material

- KOHLER enameled cast iron.

Installation

- Top-Mount or Under-mount installation.

Recommended Accessories

K-9000 P-Trap

Optional Accessories

K-8801 Sink Strainer









Codes/Standards

ASME A112.19.1/CSA B45.2

See website for detailed warranty information.

Available Color/Finishes

Color tiles intended for reference only.

Color	Code	Description
	0	White
	FF	Sea Salt™
	96	Biscuit
	47	Almond
	95	Ice™ Grey
	7	Black Black™

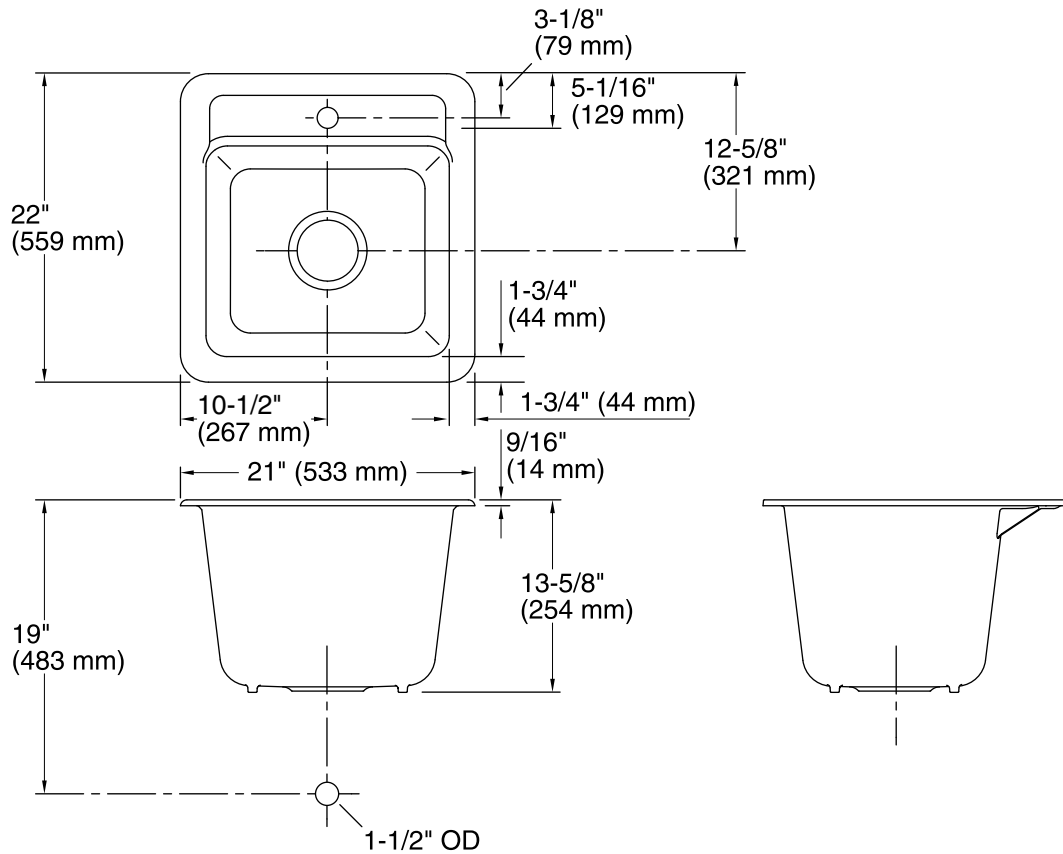

Technical Information

All product dimensions are nominal.

Bowl configuration:	Single
Installation:	Top-mount, Under-mount
Bowl area (Only)	Length: 17-1/2" (445 mm) Width: 15-3/16" (386 mm) Bowl depth: 12-1/2" (318 mm) Water depth: 12-1/2" (318 mm)
Number of deck holes:	1
Faucet hole(s):	1-3/8" (35 mm)
Drain hole:	3-7/8" (98 mm)
Template:	1079985-7, required, included

Notes

Install this product according to the installation instructions.