

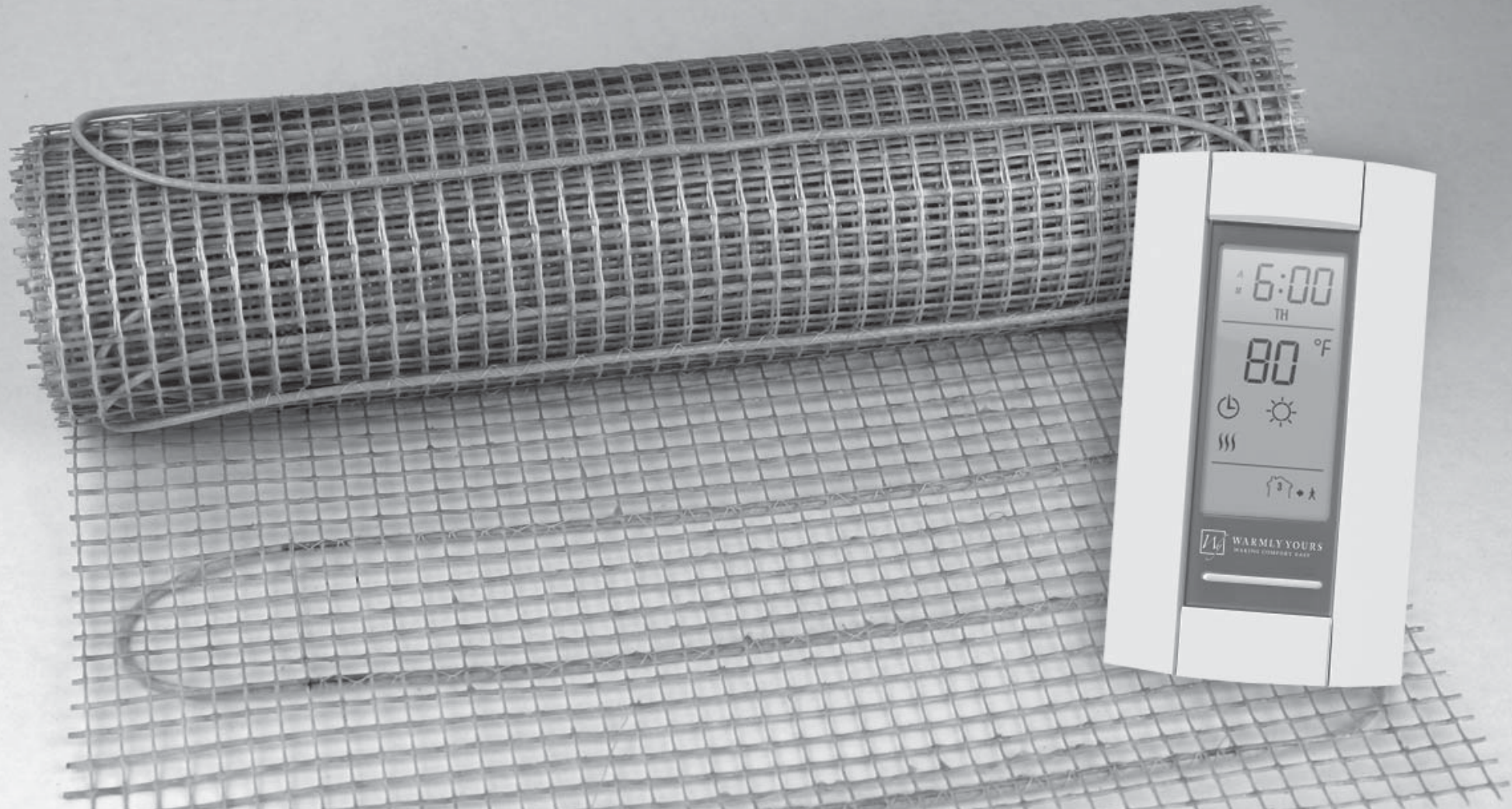

WARMLY YOURS
MAKING COMFORT EASY

Installation Manual for your TempZone™ Electric Radiant Floor Heating System



Please Read Through This Entire Manual to Assure the Proper Installation and Operation of Your WarmlyYours Floor Heating System.

Our aim at WarmlyYours is for our customers to experience the wonderful comfort and warmth that our Radiant Heating System provides. We have worked hard to design the best Electric Under Floor Heating System available in the American market. Please be sure to read this manual carefully and call us with any questions.

How To Use This Manual

The following symbols are used to denote special and important information. This will help you understand the most important considerations and items to pay special attention to.

 **Electrical Information**

 **Good To Know**

 **Very Important**

**24/7 Installation Support
at (800) 875-5285**

Table of Contents

Important Considerations	1
Understanding The System	2
Items Needed	4
Understanding The Plan	5
Cuts & Turns	6
Important Information	8
Testing The Heating Roll	9
Installer's Guide	10
Electrician's Guide	14
Owner's Information	16
Warranty	18

Unpack Your Order

Check and verify the contents of your shipment.

1. Documentation:

- This manual.
- Important Installation Information.
- Wiring Schematic for Control Device.
- Customized Installation Plan.
- Circuit Check Installation.
- Warranty Card.

2. Products:

- Heating roll(s) as indicated on your Installation Plan and quotation.
- The correct Roll length and width.
- Control device(s) of the type ordered.
- If a Programmable Thermostat is ordered, one sensor inside the Programmable Thermostat box.
- Relay Contactor or Power Modules, if required.

IMPORTANT - Cross check the items you received against the packing list and the materials list on the installation plan to ensure that the roll length(s) and thermostat type(s) are an exact match.

Check Your Documents

This installation manual covers all of the general information you will need to install the WarmlyYours Floor Heating System. It is specifically designed to cover the process of installing tile or stone as a final floor covering. For specific information on how to install the WarmlyYours mesh in cement, under carpet, vinyl, laminate or wood floors, see Pages 13 and 14.

NOTE: Keep in mind that no matter which type of flooring you install, it is critical that you follow two steps to ensure success:

- Never cut the heating element; cut the mesh only.
- Always test the resistance of the floor heating system before, during, and after its installation with a digital Ohms meter.

Double Check Your Dimensions

Check and verify that your Installation Plan has the correct room dimensions. Your order consists of the exact amount of material required to complete your project. If the measurements of your space have changed, this will affect how much product is required and how it will be installed. Once the roll(s) is/are cut into panels, it cannot be returned. If there are any discrepancies or you have any questions, call WarmlyYours.

**Monday - Thursday 7:30 am - 5:30 pm CST
Friday 9 am - 5 pm CST
(800) 875-5285
or email us 24/7 at
support@warmlyyours.com**

Important General Considerations

Your Floor Covering Choice

WarmlyYours' Floor Heating Systems are most commonly installed under stone or tile floors. If you will be installing another floor covering, please make sure you embed the WarmlyYours Floor Heating System in a minimum 3/8" of thinset or self-levelling cement before you install the final flooring material.

Insulation

Are you installing on a concrete slab? Consider adding a layer of insulation. For more details, see page 3.

Professional Electrical Installation

The installation of electrical systems presents risks of fire and electrical shock which can result in personal injury. Caution should be taken to guard against each such risk. Only a qualified electrician should connect the Floor Heating System to the control device and to the electrical circuit in accordance with the National Electrical Code and Local Codes. A tile setter, a flooring contractor, or a qualified Do-It-Your-selfer can install the Floor Heating System in the floor before the electrician connects it to the electrical circuits.

The Safety of GFCI

The WarmlyYours Floor Heating System must be connected to the electrical system via a Ground Fault Circuit Interrupter. This GFCI feature may be incorporated in the thermostat's functionality or it can be provided by the electrician, either at the circuit breaker or at the line's end, near the control device.

Protect Your Investment

To avoid damage to the Heating Element during the installation, care must be taken so that tools with sharp edges or points are not dropped or used carelessly on the Heating Element. Minimize walking on these elements and remember that when rising from a kneeling position, metallic toecaps may exert too much uneven pressure on the Heating Element. We recommend covering the exposed areas with thick pieces of cardboard or carpeting to reduce the risk of damage.

Nothing On Top

The WarmlyYours Floor Heating System must not be installed under cabinets or plumbing fixtures that will be permanently installed and attached to the floor. Built-in cabinets and other furniture or fixtures with solid bases must not be placed on the heated portion of a WarmlyYours system. Additionally carpets or area rugs thicker than 3/4" should be avoided, as they act as an insulator over the heated area, reducing the efficiency of the installation.

How High Is The Floor

While the Warmly Yours Floor Heating System is only 1/8" inch thick, it is a requirement to have a layer of thinset cement a minimum of 3/8" thick from the surface on which it rests to the bottom of the floor covering. This and the final floor covering should be calculated in the other aspects of your space such as doors, thresholds and other permanent fixtures.

Testing 1, 2, 3 Testing

If there are only two things you remember about this manual they should be: **Do Not Cut The Heating Element and Test the Resistance of the Floor Heating System Before, During and After its installation.**

1. **Before**-Test the Ohm resistance of each Heating Roll once it has been removed from the box to assure that it was not damaged in transit.
2. **During**- Test the Ohm resistance of each Heating Roll once it has been placed and secured to the subfloor to verify the Heating Roll was not damaged during the installation process. The next step will be to encase the entire system in thinset cement. Once this is done, it is very difficult to remove the product.
3. **After**- Once the floor covering is complete, test again to verify that the Heating Element was not damaged during tile setting.

An Ounce Of Prevention

Prepare your subfloor as you would for any standard installation. We recommend that you follow the standard guidelines set forth by the Tile Council of America. Special consideration should be paid to the removal of any nails, staples or other objects that may damage the Heating Element.

Beware Of Sharp Objects

Nails or screws may not be installed close to the Heating Elements and cold lead wires. At no point in time should walls or permanent fixtures be installed on top of the heated area. It is important to keep track of the Installation Plan so you or a future owner will know where the Heating Roll is located. Indicate the location of an in-floor sensor on your Installation Plan if one was installed.

9 Times Out Of 10

The easiest way to solve a problem is to pick up the phone and call us at (800) 875-5285. While we encourage you to read through the entire manual and to double check the trouble shooting section first, we want your installation experience to be trouble free.

Understanding The System Components

The Heating Roll

- A. Heating Element
- B. Fiberglass Mesh
- C. Polyblend Thread
- D. Cold Lead Wire (white)
- E. Cold Lead Wire (120V yellow or 240V red)
- F. Factory Splice
- G. Floor Sensor (optional)

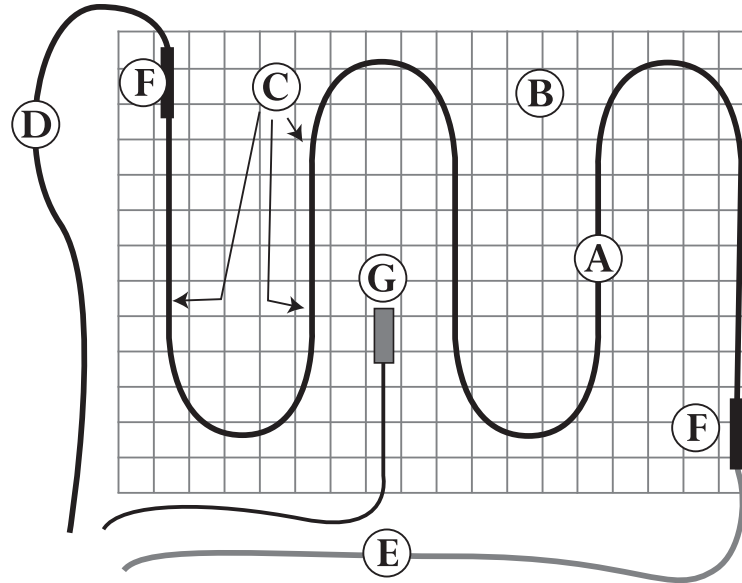
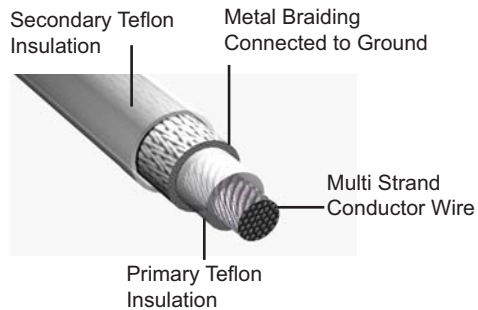

The Heating Element

The Heating Element consists of a copper alloy resistance wire covered by Teflon™ insulation. A braided metal surrounds the primary Teflon™ insulation and serves as ground sheath, before a second layer of Teflon™ insulation, serves as the outer shell. The Heating Element (A) is sewn in a serpentine pattern to a flexible Fiberglass Mesh (B) with a polyblend thread (C). The Fiberglass Mesh is designed to keep the Heating Element evenly spaced throughout the roll. The two cold lead return wires (D & E) are factory installed at each end of the Heating Roll and must run back to the power supply along the perimeter of the heated space. One return power lead (D) is marked with WHITE marks and is 26-feet in length, the other return power lead (E) is marked YELLOW for 120V or RED for 240V and is 13-feet in length. The two leads are spliced to the Heating Element (F) at the factory. If necessary these lead wires may be cut short or even extended.

Floor Sensor (not required for all systems)

Systems using a SmartStat Programmable Thermostat or EasyStat require a Floor Sensor (G). This Sensor is embedded in the floor and monitors the floor temperature. The Floor Sensor should be centered in between 2 resistance wires leaving approximately 1" on either side and extend about 6" into the heated area. Avoid placing the sensor in an area affected by a draft, a radiator or the sun. Must be installed if using a thermostat. Some people choose to install a second (Backup) sensor. For an additional cost you may purchase a second sensor.

Relay Contactor or Power Modules (not required for all systems)

Systems installed in large spaces will most likely require a Relay Contactor or Power Module(s) in addition to the control device to operate properly. The Relay or the Power Modules may be located in the same vicinity as the control device. If your system will be using this option, all, cold leads will be connected to the relay contactor or power module and not directly to the control device.

Heating Roll(s): Types and Sizes

Roll(s) are rated at 15-watts per square foot and vary in length. Each roll is designed to draw a specific amount of electricity and therefore produce the proper amount of heat based on its length. For this reason the length of the roll(s) can never be shortened to make a proper fit. Your Installation Plan has been designed to specifically accommodate your space. The same is true for rooms that have multiple rolls. Multiple rolls are never wired to each other. Each roll is wired in parallel to the control device or relay contactor.

Working With The Heating Roll(s)

The roll(s) that make up your system have been selected to fit into your floor plan. The Installation Plan shows precisely where each roll starts and ends. The "Lead Wires" on each roll are designed to travel back to the control device location. These wires do not heat. All connections are made at this point. While it may be required to cut and alter the "Fiberglass Mesh", the "Heating Element" must stay intact. Page 6 shows in detail how to make the necessary turns to install your Floor Heating System.

Separating The Heating Element From The Mesh

During the installation you may need to separate the Heating Element from the Fiberglass Mesh. This can be done with small scissors provided the Heating Element is not cut and the shielding is not nicked or punctured. It will be necessary to do this when releasing the Heating Element to make step turns and position it in a "Free Form" space.

Understanding The System

How The System Works

You can feel the heat of a campfire even though you are not directly above it. Radiant energy transfer is caused by a warm surface (the campfire) giving up its heat to a cooler surface (your body). This radiant energy travels through space without heating the space itself. It only turns into heat when it contacts a cooler surface. By transferring this heat to all of the objects in the room, the heat slowly moves to warm the air which starts to rise.

Proper Heat Dissipation

All radiant heating systems rely on a “Heat Bank”. The heat moves from the source (Heating Element) into the Heat Bank (thinset) and spreads out and warms the floor without creating an excessively hot spot. In the WarmlyYours Floor Heating System the thinset and/or self-levelling cement acts as the Heat Bank. It is important to follow the installation guidelines to create a proper Heat Bank.

Insulation – Proper Heat Retention

When WarmlyYours floor heating systems are installed on a concrete slab, we strongly recommend adding a layer of insulation to the slab prior to installing the radiant floor heating system.

While WarmlyYours systems provide up to 25% more heating power per square foot than the nearest competitor, the slab will always act as a “heat sink.” Some of the heat that would otherwise be transferred to the flooring surface will remain in the slab, causing the floor’s surface temperature to be considerably lower. This is true with any floor heating system.

When installed on top of a concrete slab without insulation, it is generally accepted that a radiant floor heating system will take the chill away from the floor and provide a small amount of warmth.

Adding insulation on top of the slab and beneath any floor heating system will allow a greater percentage of the heat generated to transfer to the flooring surface.

This leads to greater efficiency and therefore faster warm up times, higher expected surface temperatures and lower energy usage. The floor will have the capacity to warm to a comfortable temperature, and in some cases can be employed as the primary heat source for that room.

Securing The Roll(s)

Once the roll(s) is fitted into the space, it needs to be secured to the subfloor to prevent movement during the installation of the floor covering. The options for securing the roll(s) are discussed in detail on Page 12. Regardless of the method you choose, it is vital that the integrity of the Heating Element be maintained. Staples should never cross, pierce or nick the Heating Element.

Protecting The Heating Element

It is vital that proper care be taken to insure that the Heating Element is not damaged during the installation of the system or by the floor covering. A thorough preparation and detailed inspection of the subfloor will assure that any and all objects that may damage the Heating Element are removed prior to installation. Heavy gauge cardboard or carpet scraps should be used to protect the system from traffic during the flooring installation.

Never Cut The Heating Element

The key to the system is the uninterrupted flow of electricity through the Heating Element.

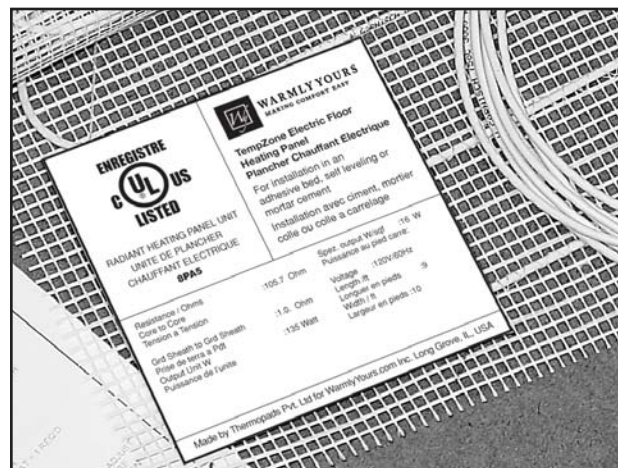

Control Device Options

Option 1: Programmable Thermostat

The SmartStat has an in-floor sensor and a digital display that indicates the exact floor temperature. It also features a manual set-back to a “high” and a “low” temperature level, and a built-in GFCI. The programmable function allows you 4 setting changes for each day of the week. Its maximum capacity is 1800 watts at 120 VAC or 3600 watts at 240 VAC . Any floor requiring more power will need to be zoned with more than one SmartStat™ and a Relay Contactor or with a Master Thermostat and a Power Modules.

Option 2: EasyStat Non-Programmable Thermostat

The EasyStat™ has an in floor sensor just like the SmartStat™, but requires no programming. Just enter the floor temperature using either Fahrenheit or Celcius. It is equipped with a GFCI and is available in 15 amps at both 120 volt and 240 voltages. A floor requiring more power will need to be zoned with more than one SmartStat and a Relay Contactor or with a Master Thermostat and Power Modules.

Option 3: Comfort Regulator

The Comfort Regulator has an ON-OFF switch and a manual dial control that allows you to increase or decrease the floor temperature. The Comfort Regulator has a built-in GFCI. Its maximum capacity is 1800 watts at 120 VAC or 3600 watts at 240 VAC . Any floor requiring more power will need to be zoned with multiple SmartStats or use a relay contactor or power module.



Items Needed For The System Installation

System Components From WarmlyYours

1. The Customized Installation Plan (or layout).
2. Heating Roll(s) (15-watt/ sq. ft.) If multiple rolls are connected to the same control device, they must be of the same voltage type and wired in parallel.
3. Control Device (one of the following):
 - SmartStat™ Programmable Thermostat
 - EasyStat™ Non-Programmable Thermostat
 - Comfort Regulator
4. You may also have a relay contactor or power module if your system is being installed in a large area.

IMPORTANT - Cross check the items you received against the packing list and the materials list on the installation plan to ensure that the roll length(s) and thermostat type(s) are an exact match.



Double Check Your Dimensions

Check and verify that your plan has the correct room dimensions. Your order consists of the exact amount of material required to complete your project. If the measurements of your space have changed, this will affect how much product is required and how it will be installed. Once the Heating Roll is cut into panels, it cannot be returned. If you have any discrepancies or questions call, WarmlyYours at (800) 875-5285.

Circuit Check

This device is provided in every order from WarmlyYours and is a continuity checker that you connect to the cold lead wires before installation of the flooring material.

Ground Fault Circuit Interrupter

GFCI or 'GFCI-breaker' indicating its capacity if not incorporated into the control device you are using. This is a built-in feature of the SmartStat Programmable Thermostat, EasyStat or Comfort Regulator.

Digital Ohm Meter (multi-meter)

Test the Heating Roll(s) before, during, and after the installation. A digital meter is strongly recommended because of the precise measurements needed.

Electrical Housing Boxes/Switch Plates

All control devices except a Relay Contactor fit into a deep single gang box. If a double gang box is used it will need to be fitted with a single gang mud ring. We strongly recommend a double gang box with a single gang mud ring as it provides more room to place all the wires.

Electrical Conduit

Local electrical codes often require the power leads be inside a metal or plastic conduit when running through the wall from the Heating Roll to the control device. When using an in-floor sensor, if local code requires the low voltage sensor wire be housed in conduit, it must use a separate conduit from the power leads (high voltage).

A Permanent Marker And Tape Measure

To measure and mark Installation Plan points onto the prepared subfloor as well as where to alter the Fiberglass Mesh of the Heating Roll(s).

Utility Scissors

Scissors are the best tool to trim and alter the Fiberglass Mesh of the Heating Roll and to separate any lengths of Heating Element from the Mesh. Never cut the Heating Element.

Hot Glue Gun, Double-Sided Tape And Or Stapler

Use these tools to affix the Fiberglass Mesh portion of the Heating Roll to the prepared subfloor before covering with thinset cement. Beware that misuse of a stapler can cause damage to the Heating Element. NEVER staple across or on top of the Heating Element.

Off-Cuts Of Cardboard Or Carpet Scraps

To protect the Heating Element during the installation.

Understanding The Customized Installation Plan

The Customized Installation Plan

This is your key to a successful installation. Your plan has been custom designed for your individual project based on the dimensions you gave us. It will indicate the placement of each Heating Roll, the electrical service requirements, and the location of the control device(s). It should be reviewed to verify that the dimensions of your room are accurate as well as the location of the permanent fixtures in your space. **If you have made any alterations to your floor plan, contact WarmlyYours to have your Installation Plan updated.**

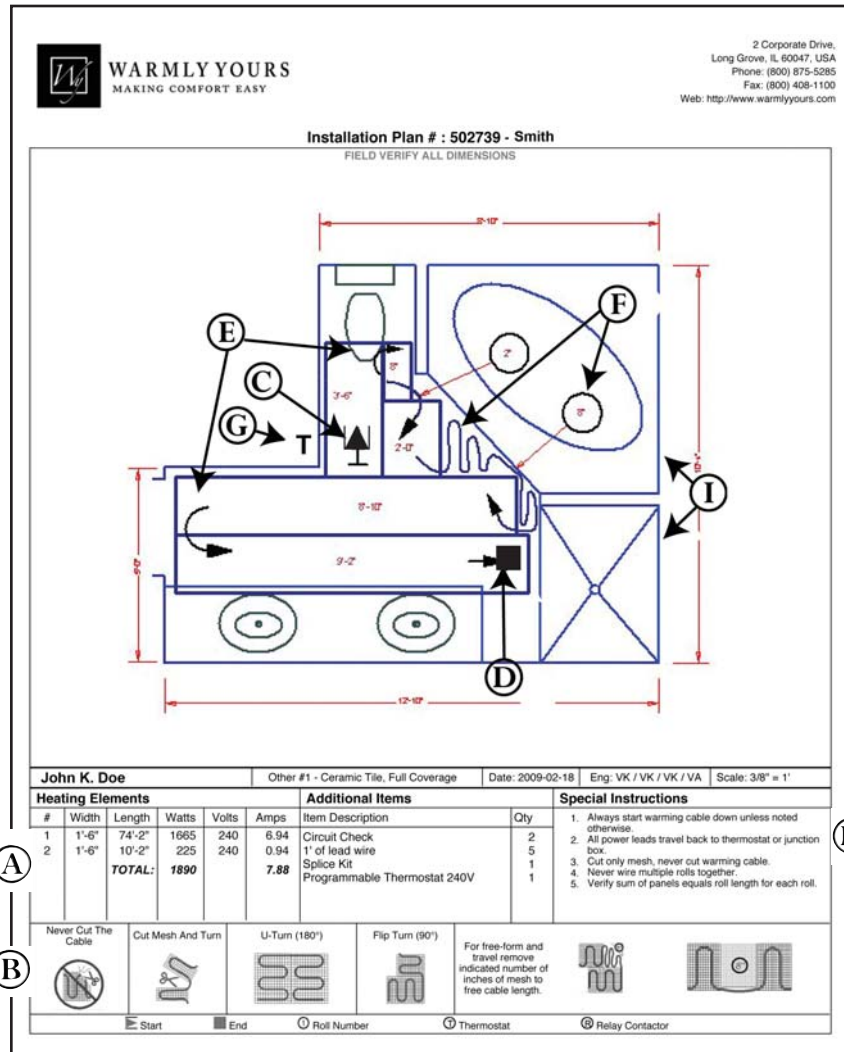

A. Materials List:

Indicates the items included in your order.

B. Legend:

Description of the items on the Installation Plan.

C. Starting Point:

Indicates where the Heating Roll(s) starts.

D. Ending Point:

Indicates the end of the Heating Roll(s).

E. Turn:

Indicates where the "Mesh" needs to be cut to make a turn allowing the roll to continue in a new direction. See Page 6 for full details on how to execute turns.

F. Free Form Space:

Indicates a length of Fiberglass Mesh that needs to be removed and separated from the Heating Element. For every 2" of Mesh removed, 1' 6" of Heating Element will be freed. This "free" wire should be manually positioned on the floor and secured with tape or glue. Staples are never recommended on the Heating Element.

G. Control Device:

Indicates where the control device is to be located on the wall.

H. Notes:

Indicates any additional information you may need including the total watts and amps drawn by the Floor Heating System.

I. Permanent Fixtures:

Indicates the location of permanent fixtures. Please note that these fixtures must not be placed on top of the heated area.

IMPORTANT - Cross check the items you received against the packing list and the materials list on the installation plan to ensure that the roll length(s) and thermostat type(s) are an exact match.

One Good Turn Deserves Another

The complimentary Installation Plan provided by the WarmlyYours team is very important. It shows the recommended placement of your Heating Roll(s) for safety and optimal efficiency. The plan will also serve as the reference for any future inspections or floor work that needs to be performed.

The Heating Element of the WarmlyYours product is sewn in a serpentine pattern on to lengths of Fiberglass Mesh forming a roll. It is quick and simple to cover large areas.

Your plan shows you where any modification is necessary. These are all easily done by cutting through the Fiberglass Mesh material (NOT the Heating Element), see Photo A , so that the roll is in two or more, moveable -but connected- pieces which are called "Panels" see Photo B. These panels can be angled, turned or completely flipped over in order to cover the space.

To cover very small or odd shaped areas, the Heating Element is used in "Free Form". A section of the Fiberglass Mesh is removed in order to release an appropriate length of Heating Element to fill the space, see Photo C. This "free" wire is placed in areas not reached by the main Heating Elements of the panels. It is also used to make "step turns" possible. Always maintain 2" spacing in all free form and step turns.

Photo A

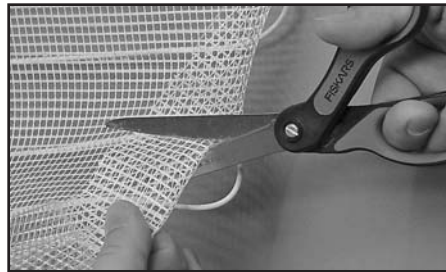

Make a single cut through the entire width of the Fiberglass Mesh. Never Cut the Heating Element.

Photo B

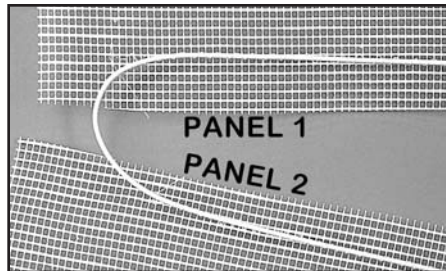

The resulting sections are called panels.

Photo C

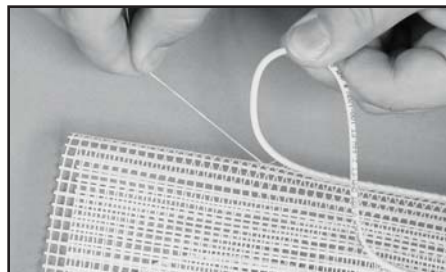

To release the required amount of Heating Element for a free form area first make the two straight cuts and then carefully cut the polyblend thread and remove it.

Cut & Turn

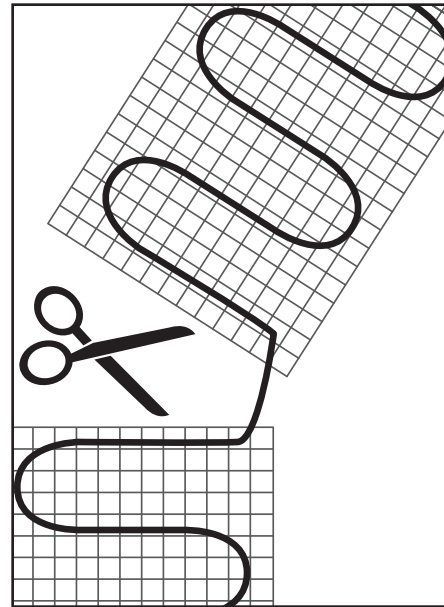

By cutting **Only The Mesh** (see Photo A), you can move the remaining section of the Heating Roll in a new direction. By doing this, you are creating what are now referred to as "panels." (see Photo B). This is the first step in any turn or alteration of the Heating Roll(s).

A turn is indicated on the Installation Plan by an arc with an arrowhead. By examining the relationship between two panels, you will determine the type of turn needed.



U Turn (180°)

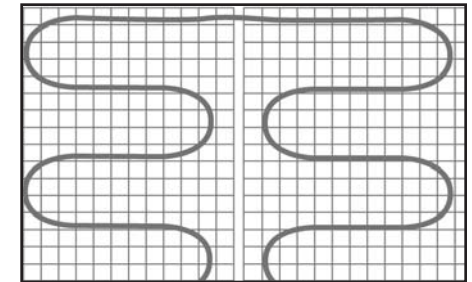

Make a Straight cut and then slide the balance of the panel around and head back in the opposite direction. Your plan will tell you exactly where to make your cut.

Flip Over Turn (90°)

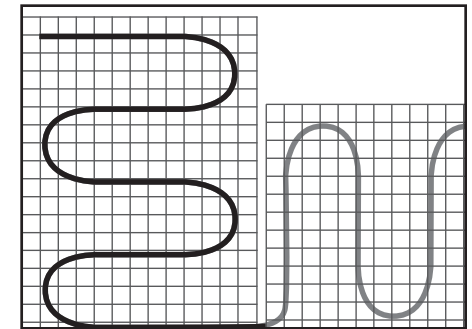

Make a Straight cut and flip the section over so that the Heating Element is now above the Mesh and continues in a perpendicular direction. Use the Installation Plan to determine the exact location for the cut.

One Good Turn Deserves Another

Free Form

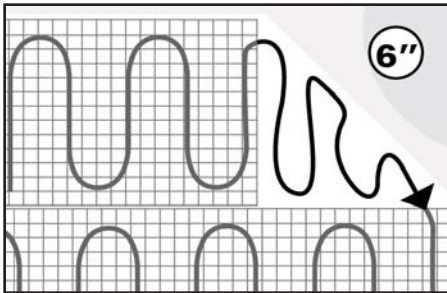

Free form spaces are filled with loose lengths of Heating Element.

A wavy line with an arrow will appear on the Installation Plan to indicate the area that needs to be filled. This symbol



is accompanied by a unit of measure in a circle that will indicate the amount of Fiberglass Mesh to be removed. (See Page 5, Item F on Installation Plan.)

Once the polyblend thread is trimmed, the Heating Element separated and the Fiberglass Mesh removed, position the Heating Element by hand and secure it to the floor with Hot Glue or Tape. Try to maintain the 2 inch spacing similar to the spacing on the Heating Roll(s).

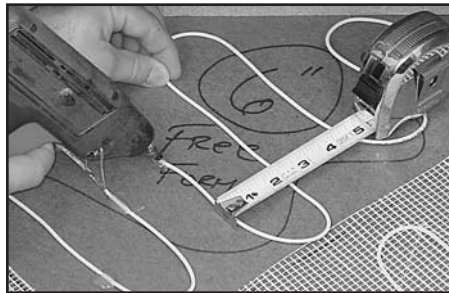

Step Turn

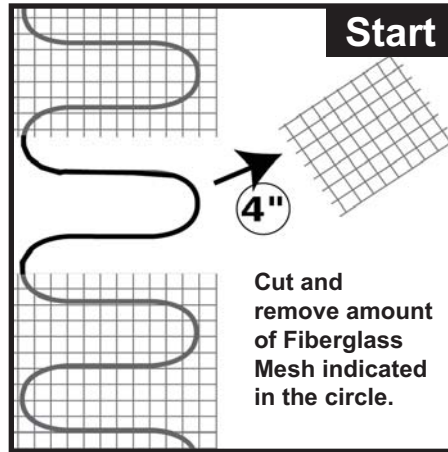

Cut and remove the amount of Fiberglass Mesh indicated in the circle and then make a U Turn. The released Heating Element is then placed in a free form manner in the stepped gap. (See Free Form this section)

This is the most popular way to do a step turn because it keeps the Heating Element under the Fiberglass Mesh offering some protection during floor covering installation.

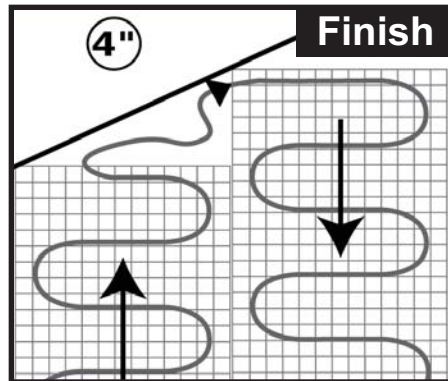

Step Turn With Flip Over

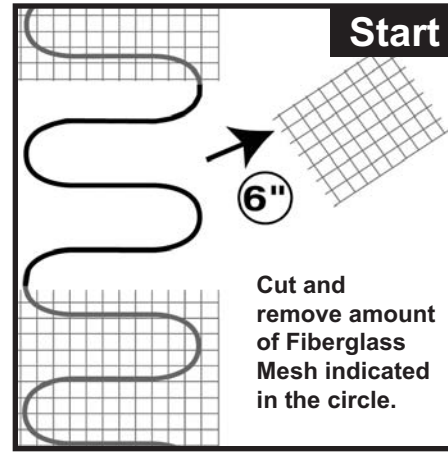

Cut and remove the amount of Fiberglass Mesh indicated in the circle and make a 180° flip turn. The released Heating Element is placed in a free form manner in the stepped gap. (See Free Form)

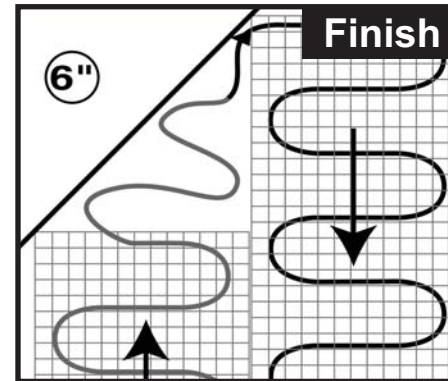

Some installations will require a Heating Panel to be placed with the wires facing up. We recommend that at the next turn the panel should be flipped over so that the Fiberglass Mesh sits on top of the Heating Element.

Working Around Obstacles

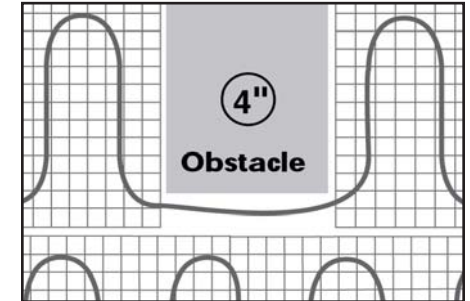

Special circumstances will require the Heating Element to circumvent an obstacle. The released Heating Element is not needed to fill an area but to simply continue the circuit.

Experience Is The key

As you begin to work with the Heating Panels, you will become more comfortable with the product. The ultimate goal is to keep even spacing of the Heating Element and the integrity of the electrical circuit.



Important General Considerations

UNBELIEVABLY IMPORTANT INFORMATION

The most important consideration is to maintain the integrity of the Heating Element. This can be easily done by following these simple rules.

1. NEVER CUT the Heating Element.
2. NEVER CUT the Heating Roll(s) to make it shorter.
3. NEVER fold or position the Heating Element so that it overlaps itself or other wires. This will cause dangerous overheating.
4. NEVER run the Cold Lead Wires or Sensor Wire across the Heating Element.
5. NEVER place built-in cabinets and other furniture with solid bases on the heated portion of the floor.
6. ALWAYS make sure the system is inspected and the Ohms tested before, during and after installation.
7. ALWAYS make sure everyone involved in the installation is aware of the care needed to protect the Heating Element from damage.
8. ALWAYS maintain consistent spacing when positioning the Heating Element.
9. NEVER connect two Heating Rolls to each other (in series). Only connect them in parallel to the same control device.
10. A dedicated circuit must be provided for the system.
11. Tiles will only be warm where the heating wire is installed. If there is no heating wire directly under the area, it will not be warm.

Note for the System Installer

Provide the homeowner with a copy of the Installation Plan provided to you by WarmlyYours.

This will help you and future owners of the home. The plan should indicate where the WarmlyYours Heating Roll(s) is installed, the location of the control device and the amperage of the system. If a sensor is used, indicate its location on the plan. The electrician should put the code labels (UL) from any Heating Roll used in a convenient place such as the circuit breaker box. The labels should have Ohm resistance readings written on them. These are a useful reference for future inspections and possible troubleshooting.

Complete the Warranty Card and return to WarmlyYours within 90 days.

Keep your plan and this installation manual safe for future reference.

Record your installation information here:

Name/Company of Electrician _____

Address _____

Tel.# _____

Location of UL labels _____

Name/Company of Floor Installer _____

Address _____

Tel.# _____

Location of Installation Plan _____

Date of installation _____

The instructions in this manual must be observed when installing the WarmlyYours Floor Heating System. Failure to follow these instructions may inhibit optimal performance of your Floor Heating System and void the system warranty. A tile-setter, flooring contractor or qualified Do-It-Yourselfer can install the WarmlyYours Heating Roll(s). However, a qualified electrician must complete the electrical connections of the system to the main electrical circuit in accordance with the National Electrical Code and your local codes. We trust that your installation goes well and that you enjoy your warm floors! Always be aware of your plan!

This is a Test - Not Only A Test

DO NOT SUPPLY THE SYSTEM WITH ELECTRIC CURRENT

All testing is done with a digital Ohm meter. Supplying the system with a 120 volt or 240 volt electric current before the installation is complete is not needed to test the system

Taking The Ohm Readings

The electrical resistance of the Heating Roll(s) must be checked before you start, and monitored throughout the installation process to ensure there has been no damage causing shorts or breaks. We recommend at least three readings be taken:

1. Before starting installation.
2. After securing the Heating Roll(s) in place on the subfloor.
3. After installing the flooring surface above the Heating Roll(s).

The Ohm resistance measurement should be within +/- 15% variance of the original measurement indicated by the factory on the UL label.

Store The UL Labels

The electrician should carefully mark the initial Ohm reading taken onto the UL label(s) from the Heating Roll(s), then place the labels in a convenient place such as the circuit breaker box. These are a useful reference for future inspections and possible troubleshooting. Should the initial Ohm reading be outside the 15% +/- variance, refer to the electrical trouble shooting section on Page 14, or call Technical Support at (800) 875-5285.

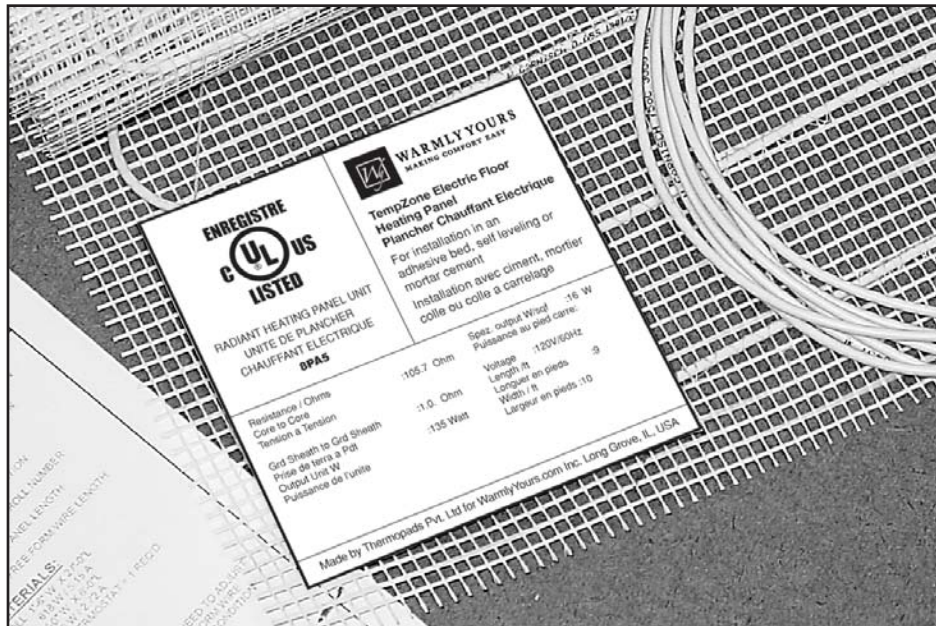

Go By The Numbers

The Ohm resistance should be measured from the inner core of the yellow (120V), or red (240V) lead wire at one end, to the inner core of the white lead wire at the other end. Make sure that the probe of the Ohm meter does not touch the tinned sheath wire at either end. Even your body's electrical resistance **can affect the reading if you touch the meter poles. Do not hold the wires onto the probes with your fingers.** A digital meter is easier to use and strongly recommended. It is wise to verify that the batteries of the Ohm meter are good. Set your Ohm meter to measure resistance in the range of 0 to 200 Ohms.

Four (4) Ohm Readings should be taken for each roll of WarmlyYours TempZone at each stage of the installation and recorded in the table below.

- 1) **Core to Core** - This is the reading between the two inner conductors on the lead wires.
- 2) **Sheath to Sheath** - This is the reading between the two outer ground sheaths on the lead wires.
- 3) **Core to Sheath START Lead** - This is the reading between the inner core and the outer ground sheath on the lead wire at the beginning of the roll. This reading should be infinity.
- 4) **Core to Sheath END Lead** - This is the reading between the inner core and the outer ground sheath on the lead wire at the finish point of the roll. This reading should be infinity.

Product # or Size	Core to Core	Sheath to Sheath	Core to Sheath START lead	Core to Sheath END lead
Ohm Reading	Ohms	Ohms	INFINITY	INFINITY
After Unpacking			<input type="checkbox"/> Check	<input type="checkbox"/> Check
After laying roll on floor			<input type="checkbox"/> Check	<input type="checkbox"/> Check
Now connect Circuit Check and leave connected until installation of the floor is complete				
After laying tile			<input type="checkbox"/> Check	<input type="checkbox"/> Check
Record the Ohms readings on the warranty card included with your system and return it to WarmlyYours				

After the installation, if necessary, the position of a break can be found with a time domain reflectometer. Repair kits and guidance are available from the WarmlyYours support line. Details of how to repair a damaged Heating Element are also available on our web site at www.warmlyyours.com/install/floor-heating/manuals-diagrams/. Look under troubleshooting.

Installer's Guide

STEP 1

Electrical Planning

The power supply to the Floor Heating System and the control device will be located at the same point in the room and indicated on your plan. If this location has changed, call WarmlyYours to determine if this will require a new Installation Plan. The yellow (120V) or Red (240V) lead wire is 13' long and the white lead is 26'. You can relocate the control device as long as your leads reach the new location.

The thermostat requires a deep single or a double gang box with a single gang mud ring and should be positioned in a convenient place for easy access. From the gang box, two sets of wires will go to the floor:

- Set 1) The 120-volt or 240-volt cold lead wires that power the system
- Set 2) The low voltage sensor wire if a SmartStat or EasyStat thermostat is being installed.

⚡ Some local electrical codes require the low voltage and/or 120-volt wires above the floor to be installed in conduit. **The low voltage sensor wire must not be placed in the same conduit as the 120-volt or 240-volt power supply.** The portion of the cold lead that is installed in the floor will be directly covered with thinset cement or a flooring adhesive.

All lead wires will travel back to the control location (either directly or through a Relay Contactor) **AND MUST NOT CROSS OR COME IN CONTACT WITH THE HEATING ELEMENT.**

STEP 2

Prepare The Subfloor

Inspect the subfloor surface carefully. Remove all debris and grind any sharp edges of cracks. It is important to remove any sharp edges or pointed objects that might damage the Heating Element.

Cement Subfloors - Insulate for Heat Retention

We strongly recommend adding a layer of insulation to the concrete slab prior to installing the floor heating system. Secure the insulation to the subfloor before installing the floor heating system.

! Expansion joints require special consideration. Heating panels cannot cross these joints and your Installation Plan should accurately indicate all joints. If your Installation Plan does not match your subfloor, contact Warmly Yours to have a new plan designed.

Plywood & Cementboard Subfloors

Remove all debris, staples and nails. Repair any loose boards and sand the edges of any boards that are at different elevations. Although you may lay the Floor Heating System directly on top of the wood subfloor, some installers prefer to avoid direct contact by first applying a 1/8" to 1/4" layer of thinset cement and letting it dry. Both methods are acceptable.

Mudbed Subfloors

The Heating Roll(s) are always installed on top of the Mudbed in the thinset used to adhere the tiles.

! It is advised to prepare the subfloor as you would for any conventional installation along the Tile Council of America Guidelines.

STEP 3

Mark The Floor

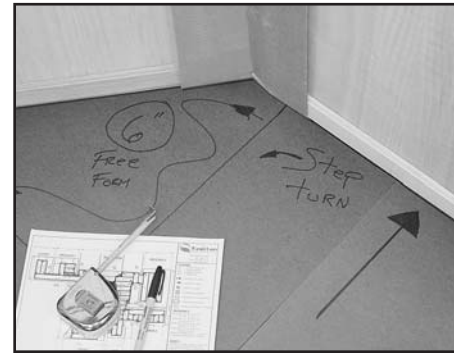

Using a suitable pen, and referring to the Installation Plan provided, mark off areas on the floor where permanent/heavy fixtures will rest. (Cabinets, toilet bases, etc.)

Mark the position of the sensor (if one is to be used) as well as the planned route of the cold lead wires and sensor wire (if used).

Indicate where the Heating Roll(s) will need to be cut and the Fiberglass Mesh will be removed to customize the roll(s) with flips, turns and where freeform spaces will be located as indicated on your Installation Plan.

! Refer to Page 6 to understand how to customize and alter the Heating Panels with flips, turns and freeform spaces.

! Refer to Page 7 to develop an understanding of where the Heating Panels need to be placed in relation to permanent fixtures and trafficked areas.

STEP 4

Mark The Roll

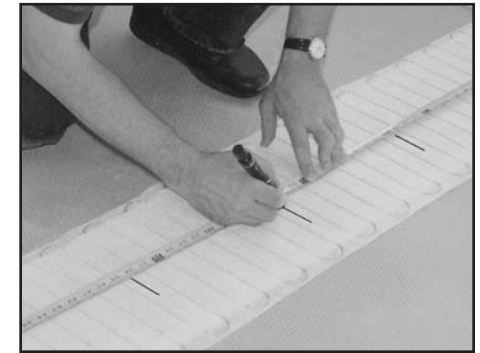

On the Heating Roll(s), mark the location for the planned cut and turns and the length of the free form cuts. Do this from the beginning to the end of the roll; this is the last time you can make sure that the total of all panel lengths on your Installation Plan is the same as the length of the roll you received.

If there are any changes or discrepancies with the Installation Plan, you will be able to choose different locations for the cut-&-turns, but the reference marks on the roll will help you to always know if you are effecting turns a few inches ahead-or-behind what was designed on the Installation Plan. Remember that **if you extend 3 panels by 4", at the end you will be missing a 1' length of Heating Roll.** Plan any deviation from the Installation Plan accordingly.

Installer's Guide

STEP 5

Check Roll(s)

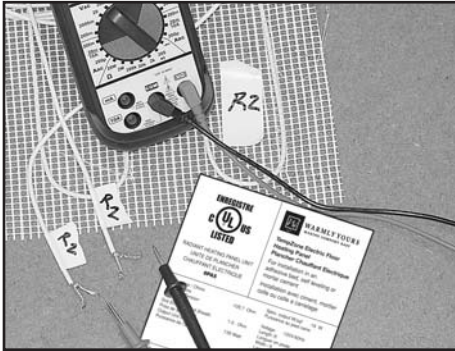

Unpack the Warmly Yours Heating Roll(s) and check the Ohm resistance between the two conductor wires to ensure there is no break or short in the cold lead conductors or the heat resistance wire. Each Heating Roll is labeled with its size and Ohm resistance.

If your installation uses two or more rolls, label each one with the corresponding roll number (ie. "R2", R3, etc.) found on the Installation Plan. Be sure to mark the UL label on the roll itself and the ends of both cold leads so that subsequent testing will allow you to determine which roll your Ohm readings are from. Record the readings from each roll on the Ohm log on Page 9 of this manual.

Ohm Reading #1

The Ohm resistance measurement should be within +/- 15% variance of the original measurement indicated by the factory on the UL label. If your readings are outside of this range, refer to the electrical trouble shooting section on Page 14, or contact Technical Support at (800) 875-5285.

STEP 6

Place Roll(s)

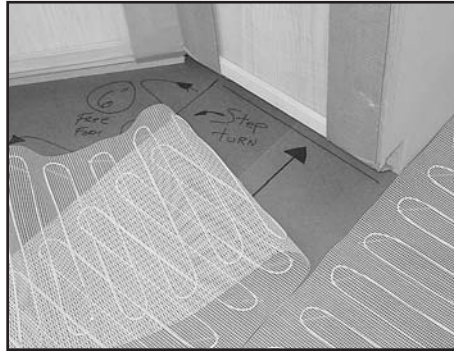

Dry fit the Heating Roll(s) according to the Installation Plan and your floor markings. This will give you an opportunity to make any adjustments in roll location. Be careful not to fold the roll sharply as any sharp kink may damage the Heating Element.

! Refer to Page 1 on the key areas to cover and avoid.

When fitting the Heating Roll(s), the Heating Element can be either above ("wires up") or below ("wires down"). We designed your Installation Plan to assure that most Heating Panels will be installed wires-down, with the Heating Element below the Fiberglass Mesh. Application of thinset cement will be easier when the Heating Element is below the Mesh and the Mesh offers some protection during the floor installation. Only after a 90° flip-over turn will the heating Element be above the Mesh, and we recommend that at the next free-form opportunity you reverse to a wires-down position.

STEP 7

IMPORTANT



Careless use of tools and excessive traffic during the next few steps is the leading cause of damage to the Heating Element. Never drop or bang a tool on the Heating Element.

Minimize walking on the Heating Elements and remember that when rising from a kneeling position, toecaps may exert too much uneven pressure on the elements.

We recommend the use of thick scraps of cardboard or carpeting squares to reduce the risk of damage.

Make sure that everyone involved in the installation or performing other work in the space during the installation process is aware of the extra care needed to protect the Heating Element.

STEP 8

Fit The Roll(s)

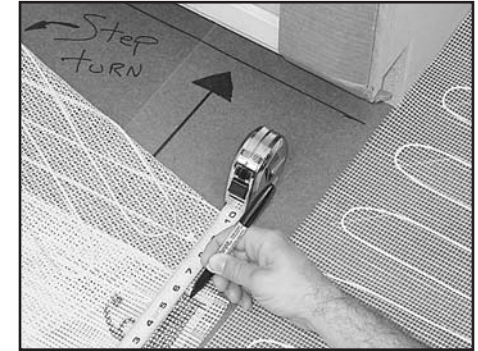

Fit the Heating Roll(s) one panel at a time. Execute the cuts-&-turns according to your Installation Plan and modify the roll into successive and interconnected panels shaped to cover the planned area.

Use the instructions on Pages 6 & 7 to make the proper turns and fill the freeform spaces with the length of Heating Element indicated on your Installation Plan.

! When customizing your Heating Roll(s), cut only the Fiberglass Mesh. Never cut the Heating Element when fitting the panels. Follow the guidelines on Pages 6 & 7.

Installer's Guide

STEP 9

Secure The Panels



Once you have determined that the Heating Panels will fit in accordance with the Installation Plan and that the cold lead wires will travel back to the power supply without crossing over the Heating Element, you can start to secure the Heating Panels to the subfloor.

We recommend using a hot melt glue gun with high temp melting glue sticks. Glue can be placed on the Fiberglass Mesh and the Heating Element as needed to secure all of the panels to the subfloor. (Double stick tape is also suitable for securing the panels)

▲ While a staple gun will work on wood subfloors it is vital to avoid any contact between staples and the Heating Element.

STEP 10

Check Spacing

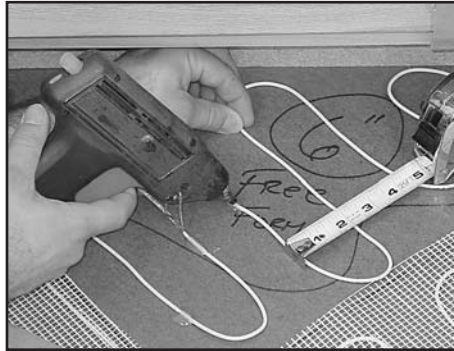

Secure the Heating Panels in the free form areas. Heating panels must not be laid too close together. Check the maximum distance between wires inside the Fiberglass Mesh and maintain at least 60% of this distance when positioning free form areas.

Spacing the wires too widely may create cold areas. Remember heat will travel only 1" from each wire.

⚡ Never overlap wires. Heating Panels that overlap will cause dangerous overheating. Cold lead wires that overlap the Heating Panels may cause a short circuit.

Ensure that the yellow (120V) or red (240V) and the white (cold) power leads can reach the control device without overlapping other wires.

STEP 11

Install The Sensor

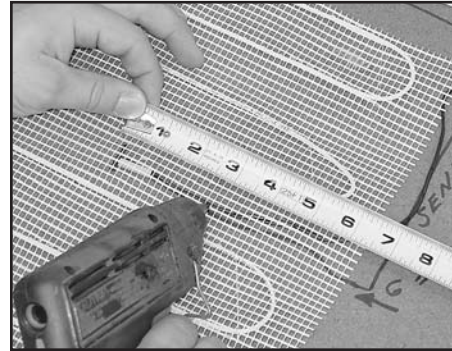

If you are installing a Comfort Regulator go to Step 12.

If you are installing a Thermostat, the floor sensor should be placed below the Fiberglass Mesh centered between the Heating Element and held in place with a little thinset or hot glue.

Check the Ohms reading of the sensor wire before and after installation to make sure it has not changed. Most sensor wires have Ohms readings of 8,000 to 20,000 and your OHM meter must have a 20 kohm setting for this measurement.

The sensor wire cannot cross any Heating Element or lead wire. It must project at least 6" into the heated area. The sensor and its wire should be covered directly with thinset cement or adhesive.

If the local electric code in your area requires low voltage wires behind the wall to be installed in conduit, it should be **placed in a separate conduit than the one used for the higher voltage cold lead wires that power the system.**

STEP 12

Affix Lead Wires

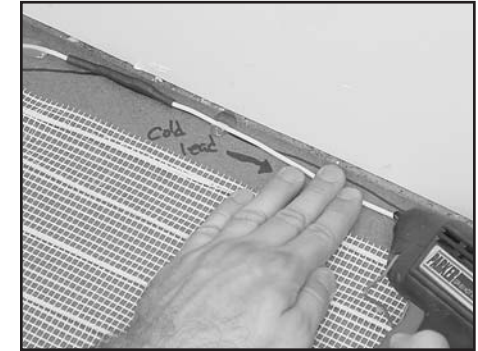

The two cold lead (non-heating) power wires are 1/8" thick and are factory installed at the ends of the Heating Roll. These cables may be shortened or extended, but remember that they are constructed like coaxial cables with a sheath around the core conductor. The sheath needs to be grounded at the control end.

The yellow or red cold lead is approx. 13 feet long and is generally considered the "Start" of the Heating Roll. The white cold lead is approx. 26 feet long and is generally considered the "End" of the Heating Roll.

The return cold lead wires should be placed above the subfloor, along the side of the Heating Panels. Secure them with suitable tape or hot glue before the thinset or floor adhesive is applied over the cables.

The return cold lead will go into the conduit for electrical wiring flush with the wall. Use plastic bushings. .

Read Steps 13,14 & 15 Before Proceeding

STEP 13

Ohm Reading #2

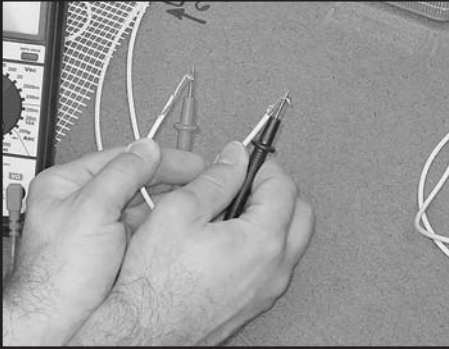

Take another Ohm reading to check the element for damage.

Record readings on Page 9 of this guide.

A 'good' reading is within 15% variance +/- of the factory reading which is on the UL label.

If your system uses two or more Heating Rolls, make sure you have labeled the cold lead wires with their roll number.

Keep in mind that the next step is to embed the Heating Roll(s) in a layer of thinset cement. NOW is the time to discover any problems with the Heating Element continuity. Once the thinset is applied it becomes much more difficult to repair any damage. Before embedding Heating Roll(s) in thinset attach the Circuit Check to the cold leads

STEP 14

Embed Elements



Embed the Heating Roll(s) over the subfloor with a single or double layer of a "modified" thinset cement. Acrylic, latex or polymer "modified" thinset cement are all examples of thinset applications that will work well.

Make sure that your adhesive is compatible with your flooring material. Contact the adhesive manufacturer or the Tile Manufacturer to find out.

Careless use of the trowel can cause damage to the Heating Element. Never drop or bang a tool directly on the Heating Element.

A single or double layer method may be used over any subfloor (plywood, cement slab, concrete backer board or mud bed). These methods are suitable for any stone or tile floor covering.

If your floor covering will be carpet, vinyl or laminate you will need a two stage application to produce the smooth surface for these types of flooring.

STEP 15

▲ Choose This ▲

**FOR TILE & STONE FLOORING
CHOOSE 1 OF THESE:**

1. Single Layer Method

Apply a layer of 3/8" (minimum) thinset cement or adhesive over the Heating Roll(s).

Lay the tile or stone directly into that layer of thinset cement.

OR

2. Double Layer Method

Embed the Heating Roll(s) in a skim coat of thinset or adhesive completely covering the Heating Element and the sensor wire.

Apply a second layer of thinset or adhesive and lay the tile as usual. A required minimum total for both layers is 3/8" of thinset or adhesive.

In choosing between the single layer or the double-layer method you may want to consider the following: We do NOT recommend the single-layer method if you will install mosaics or a combination of tiles of different sizes, or if this is the first time you install an electric radiant heating system under ceramic tiles or natural stones. The single layer method is used most by experienced installers in small applications with easy access (example: a rectangular area in front of the kitchen sink, but not necessarily a small bathroom with an odd shape area that is difficult to access).

▲ Choose This ▲

▲ Waiting Period ▲

Ceramic tile and stone installations require 2 to 14 days for the thinset to cure. **You must allow the thinset material to fully cure before the WarmlyYours Floor Heating System may be operated fully.** Failure to do so will result in damage to the system and cause the thinset to become brittle.

Warmup Time

! If you desire a warm up time of approximately one hour, then the amount of material above the heating element should not exceed one inch.

FOR CARPET, VINYL OR LAMINATED FLOORING

Two Stage Method

Embed the Heating Roll(s) in a first layer of thinset or adhesive and let it dry.

Float a second layer of self-leveling cement to obtain a smooth, flat surface. A minimum total for both layers is 3/8" of thinset, self leveling cement and/or adhesive is recommended.

NAILED HARDWOOD FLOORING

On the plywood subfloor you need to place wood sleepers every 18". These spacers are 3/8" or 1/2" high and about 1" to 2" wide. They create 18" lanes in which you would place the WarmlyYours Heating Roll(s). Make sure your Installation Plan has incorporated that feature or call WarmlyYours at 1-800-875-5285. The Heating Roll(s) is then covered with 3/8" of self leveling cement to come up to the level of the wood sleepers, and finally, the hardwood floor is nailed into the wood sleepers

STEP 9

▲ IMPORTANT ▲



Ohm Reading #3

Take a third Ohm reading to check the Heating Element for damage.

Record readings on Page 9 of this guide. At this time your three readings should match within the 15% variance.

Electrician's Guide

▲ IMPORTANT ▲

Call An Electrician!

A tile-setter, flooring contractor or qualified Do-It-Yourselfer can install the WarmlyYours Floor Heating System.

A qualified electrician must complete the electrical connections of the system to the main electrical circuit in accordance with the National Electrical Code or local codes.

If you would like help locating an experienced electrical professional, please contact WarmlyYours. We have worked with hundreds of electricians and will be happy to try and locate one in your area.

TURN OFF THE POWER AT THE MAIN POWER PANEL TO AVOID ELECTRICAL SHOCK.

IMPORTANT

Checking Continuity for Electrical Short Circuits

On rare occasions during the installation process, the insulation between the tinned multi-stranded sheath and the core conductor of the Heating Element may be damaged.

An opening in the insulation layer may create an electrical short, even though the Ohm reading from the white conductor to the yellow or red conductor is normal and does not indicate any circuit break

There should be no continuity (that is, an 'infinite' resistance reading, not

'zero') between the white conductor and the white sheath.

There should be no continuity between the yellow/red conductor and the yellow/red sheath.

There should be a low resistance reading between the white sheath and the yellow/red sheath.

Connect Electricity

Before shortening the cold leads, make sure the color indicators on the wire are visible at the box and thermostat location. If not, place a piece of corresponding colored tape on each of the leads.

The electrical wiring should follow the wiring instruction schematic provided. Multiple Heating Rolls may be connected in parallel to the same control device. **The Heating Rolls may not be connected in series to each other.**

The amps rating of the control device limits the total number of Heating Rolls that can be controlled by a single control device. A Relay Contactor or Power Modules is required when the amps drawn is greater than the amps rating of the field installed control device.

GFCI

The Floor Heating System must be connected to the electrical service via a Ground Fault Circuit Interrupter (GFCI). The GFCI feature may be incorporated in the thermostat. A GFCI circuit breaker will be needed ONLY if using an RC-40 Relay. GFCI protection is not provided by the thermostat when using an RC-40 relay.

Floor Sensor

Connect the sensor wire to the designated screws on the terminal block on the base of the thermostat. The sensor wire must pass outside the electrical box and follow the wall down to the floor.

As the sensor wire is low voltage, most electrical regulations do not demand conduit. However, do not house the low voltage wire in the same conduit as the 120 or 240 volt return power lead wires.

Electrician's Guide - Trouble Shooting

Examine System

The WarmlyYours Floor Heating System is maintenance free and guaranteed for 10 years against factory defects. If a complete system fails to function as expected, first check the following:

1. Make sure the breaker or fuse is delivering power to the system.
2. Re-read all control device instructions.
3. See if the Ground Fault Circuit Interrupter (GFCI) has been tripped. This could indicate wire faults, but may be due to external factors such as a power surge.

If your system contains more than one Heating Roll and you have a cold area, or if the above actions do not yield results, you will need to call your installer. Be sure to give the Model Number from the UL label(s) of your system.

Electrician's Guide - Trouble Shooting (Cont.)

If further technical assistance is necessary, your electrician may contact WarmlyYours.com at 1-800-875-5285.

Note: “Beware Of Using A Continuity Checker!”

Our smaller Heating Rolls have a high Ohm resistance and some continuity checkers do not send enough current to go through and emit the noise or light that affirms proper continuity. If your instrument cannot function on a small Heating Roll, please use a digital Ohm meter.

Electrical Fault-Finding

Once the system has been turned off and made safe, have a suitably qualified person:

1. Ensure all wires have been connected as per the wiring diagrams.
2. Make sure multiple rolls have been wired in parallel and not in series.
3. Confirm that control devices are receiving correct voltage.

Use a well calibrated digital Ohm meter with good batteries. The Ohm resistance level of each Heating Roll should be checked and the reading compared with the resistance that was recorded during installation on the corresponding UL label(s) (located on the circuit breaker) and in the log on Page 9 of this Manual.

If your reading is not within the 15%+/- range from the original reading, the roll may be damaged in some way.

If you get zero across the core or ground sheath, this indicates an open or short circuit beneath the finished flooring. The electrical contractor must locate the point of break or short, in coordination with the Technical Services Department of WarmlyYours.com.

Locating A Break Or A Short

If your installation is complete, all wiring connections have been verified to be correct, including grounding of the system, you have checked the sensor wire for proper Ohms reading, and you suspect the system is still not working; you need to determine if there is a break or a short under the floor.

Checking For Breaks

The Ohm resistance of each roll should be measured from the core of the yellow or red conductor wire at one end, to the core of the white conductor wire at the other end.

Make sure the probes of the Ohm meter do not touch the sheath wire at either the yellow/red or the white ends.

Make sure you do not touch either of the probe ends with your fingers, or the meter will be reading your internal body resistance.

Make sure your Ohm meter is set on the proper scale (0-to-200 for Heating Rolls, or 0-to-20,000 for the sensor wire).

Your Ohm resistance readings should come within 15% (plus or minus) of the original measurement indicated by the factory on the UL label.

If your Ohm reading is within 15% of what it should be, there is no break. However, you still need to check for an electrical short.

If your Ohm reading is lower (outside the 15% range), but there is clearly some continuity, check your Ohm meter and your batteries. If these are good, there is a possibility that you have several electrical shorts.

Infinity Ohm Reading?

If you have absolutely no reading (= infinity on your meter), and you are sure you adjusted the setting of the Ohm meter to the correct reading range (0-to-200 for the Heating Rolls, or 0-to-20,000 for the sensor wire), then you have a break (= total cut) in the conductor.

Checking For Electrical Short

In some rare occasions an installation may have suffered from a high pressure point that broke the insulation between the core conductor and the tinned multi-stranded sheath. Such an opening in the insulation layer can create an electrical short, even though the Ohm reading from the white conductor to the yellow or red conductor is normal and does not indicate any circuit break. In these rare occasions a continuity test will show continuity between the white core conductor and the white sheath wires, and/or between the yellow or red core conductor and the yellow or red sheath wires.

There should be no continuity (=“ infinite” resistance reading, not zero) between the white conductor and the white sheath.

There should be no continuity (=“ infinite” resistance reading, not zero) between the yellow/red conductor and the yellow or red sheath.

There should be a low resistance reading between the white ground sheath and the yellow/red ground sheath (generally under 3 Ohms, never over 8 Ohms in 120V rolls or 14 Ohms in 240V).

If your instrument reveals continuity between the white core conductor and the white sheath, there is a short in the circuit. You can approximate the location of the circuit short with 4-Ohms resistance measurements.

Approximating The Location Of An Electrical Short:

In order to locate the approximate position of the short, you need to take 4-Ohm resistance measurements:

1. From the white core conductor to the yellow/red core conductor.
2. From the white sheath to the yellow/red sheath.
3. From the white core conductor to the white sheath.
4. From the yellow or red core conductor to the yellow/red sheath.

The percentage ratio of the third and fourth Ohm measurement reveals the approximate location of the circuit short. For example: if the third Ohm measurement is 25% of the total of third-&-fourth Ohm measurement, the circuit short is approximately at 25% of the roll length, starting from the white end.

There is another way to locate breaks or circuit shorts with an underground fault detector.

A short can most easily be found with a “time domain reflectometer” tester, which will measure the distance of the wire between the tester and the short point. WarmlyYours has several of these testers available to assist our installers.

Breaks and shorts may generate some heat and they can also be found with infra-red cameras scanned over the floor.

Have your electrician call WarmlyYours.com at

1-800-875-5285 if you need any assistance.

Owner's Information

Check The Work

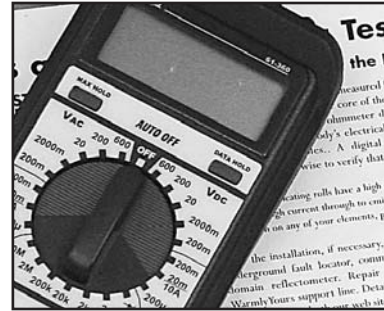

Make sure the person doing the electrical work has:

1. Completed the log on Page 9 of this Manual.
2. Labeled the circuit that supplies the WarmlyYours Floor Heating System.
3. Remembered to put the UL label/s in a safe place (e.g. taped to the circuit breaker door) for future reference.

Be sure to record the Electrician's details on Page 8 of this Manual. It will be helpful to use the installation Notes section below to record any information about your installation for future reference.

Installation Plan

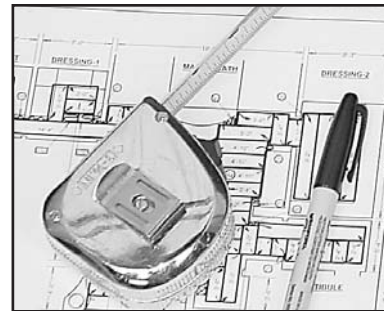

When the floor surface is laid over the embedded Heating Roll(s), ensure care is taken not to drill or drive nails and screws in the vicinity of the Floor Heating System.

Make everyone aware of the Installation Plan.

The Installation Plan should be passed along with the sale of your home.

At no point in time should there be walls or permanent fixtures installed over the heated areas of the system. It is your responsibility to pass this information along to the next homeowner or any remodelers.

An Example of Parallel Wiring



WARMLY YOURS
MAKING COMFORT EASY

WIRING DIAGRAM

FOR 120V & 240V MULTIMAT TEMPZONE WITH
SMARTSTAT™ / EASYSTAT™ / COMFORT REGULATOR

ITEM #: TH115-AF-GA
ITEM #: TH114-AF-240GA
ITEM #: TH113-R-GA-08

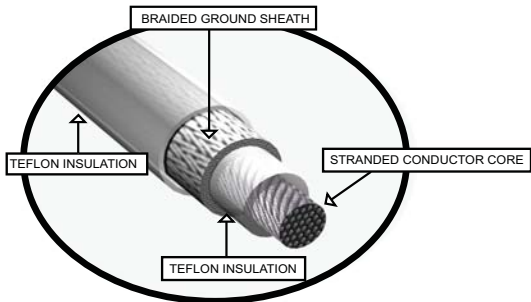

1. MAT HAS **NO** POLARITY
2. RED OR YELLOW INDICATORS ON COLD LEAD INDICATE "BEGINNING" OF MAT. WHITE INDICATORS SIGNIFY "END" OF MAT
3. COLD LEAD IS 13" AT "BEGINNING" OF MAT, 26" AT "END" OF MAT (20' & 40' LEADS ON 3' WIDE MATS)
4. ENSURE THAT ALL COLD LEADS PRESENT IN THERMOSTAT BOX ARE THE SAME DIAMETER
5. **DO NOT** SHORTEN MAT

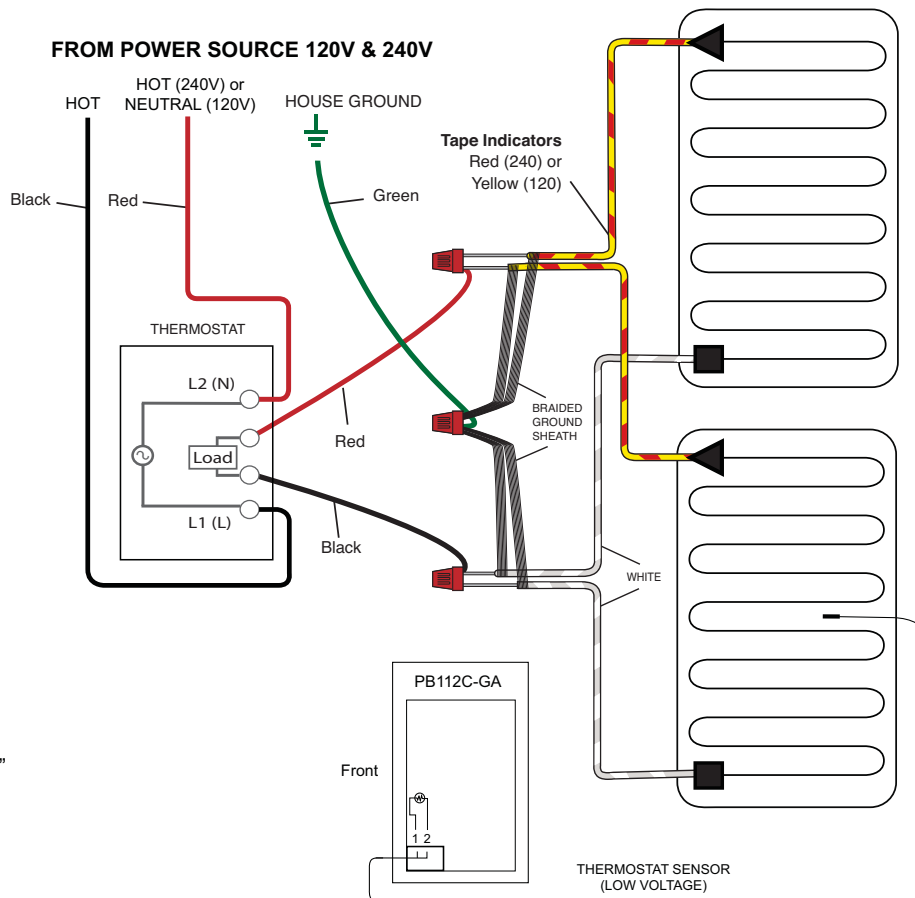

ENSURE THE SYSTEM IS GROUNDED



