

Royal® Model Flushometer

144 144-1.6



► Description

Concealed Water Closet Flushometer, for wall hung back spud bowls.

► Flush Cycle

- Model 144 Water Saver (3.5 gpf/13.2 Lpf)
- Model 144-1.6 Low Consumption (1.6 gpf/6.0 Lpf)

► Specifications

Quiet, Concealed, Diaphragm Type, Rough Brass Closet Flushometer for either left or right hand supply with the following features:

- PERMEX™ Synthetic Rubber Diaphragm with Dual Filtered Fixed Bypass
- ADA Compliant Metal Oscillating Non-Hold-Open Handle with Triple Seal Handle Packing
- 1" I.P.S. Wheel Handle Bak-Chek™ Angle Stop
- Adjustable Tailpiece
- High Back Pressure Vacuum Breaker
- Spud Coupling for 1½" Concealed Back Spud
- Sweat Solder Adapter
- Elbow Flush Connection
- Exposed parts Chrome Plated
- High Copper, Low Zinc Brass Castings for Dezincification Resistance
- Non-Hold-Open Handle, Fixed Metering Bypass and No External Volume Adjustment to Ensure Water Conservation
- Flush Accuracy Controlled by CID™ Technology
- Diaphragm, Handle Packing, Stop Seat and Vacuum Breaker to be molded from PERMEX™ Rubber Compound for Chloramine Resistance

Valve Body, Cover, Tailpiece and Control Stop shall be in conformance with ASTM Alloy Classification for Semi-Red Brass. Valve shall be in compliance to the applicable sections of ASSE 1037, ANSI/ASME 112.19.6, and Military Specification V-29193.

► L Dimension

Specify the "L" Dimension for the proper length of the Handle Assembly and Flush Connection. The "L" Dimension is equal to the Wall Thickness (to the nearest whole inch) plus 2¾" (70 mm).

► Variations

- TP** Trap Primer Elbow
- WB** For installation with Sloan Easy Access® Wall Box
- YI** Two Wall Bumpers (for open front seat without cover)

See Accessories Section of the Sloan catalog for details on these and other Flushometer variations.

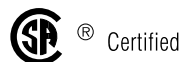
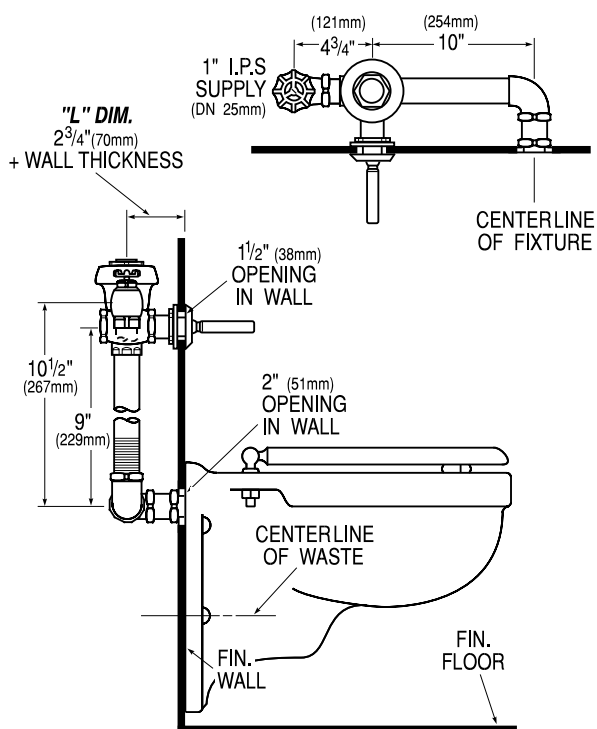

This space for Architect/Engineer approval

The information contained in this document is subject to change without notice.

SLOAN®

Made in the U.S.A.
SLOAN VALVE COMPANY • 10500 SEYMOUR AVE. • FRANKLIN PARK, IL. 60131
Ph: 1-800-9-VALVE-9 or 1-847-671-4300 • Fax: 1-800-447-8329 or 1-847-671-4380
<http://www.sloanvalve.com>