

Knob and Lever Latchsets

- Will fit 2 1/8" bore.
- For commercial and residential use.
For commercial use, please specify at time of order.
- 2 3/8" and 2 3/4" backsets available.
- Supplied for 2 3/8" backset and 1 3/8" door thickness unless otherwise specified.
- All lever latchsets are ADA approved.

Concealed Screw Roses:

Modern	2 9/16" dia. x 7/16" proj.
Traditional	2 5/8" dia. x 1/2" proj.
Beaded	2 5/8" dia. x 1/2" proj.
Roped	2 5/8" dia. x 1/2" proj.
Reed & Ribbon	2 5/8" dia. x 1/2" proj.
Ornate	2 5/8" dia. x 1/2" proj.

Thru-bolted roses have been specifically designed for use with the knobs and levers with which they are shown. Each set consists of solid brass knobs or levers, concealed screw thru-bolted roses, latch, spindle and all necessary mounting screws, installation template and instructions.

About our Tubular Latch

- Patented worldwide.
- Star shaped hubs for knobs and square shaped hubs for levers.
- All dimensions are standard to fit existing bores for replacement installations.
- Tough, non-rusting materials used throughout. Face covers and strikes are solid brass. No. 013 "T" strike supplied as a standard or No. 014 "Full Lip" strike as an option. Specify when ordering.
- Critical interior parts are made of solid brass.
- For over three decades these latchsets have been opening and closing hundreds of thousands of doors all around the world.



All Omnia lever latchsets meet ADA accessibility requirements.

Knob Strength Latches

- 109: 2 3/8" backset latch for oval knobs with square hub for 7mm spindle.
- 111: 2 3/4" backset latch for oval knobs with square hub for 7mm spindle.
- 114: 2 3/8" backset latch for knobs with star hub for 3/8" dia. threaded spindle.
- 116: 2 3/4" backset latch for knobs with star hub for 3/8" dia. threaded spindle.

Lever Strength Latches

- 110: 2 3/8" backset latch for levers with square hub for 7mm spindle — pitched.
- 112: 2 3/4" backset latch for levers with square hub for 7mm spindle — pitched.
- 115: 2 3/8" backset latch for levers with star hub for 3/8" dia. threaded spindle.
- 117: 2 3/4" backset latch for levers with star hub for 3/8" dia. threaded spindle.

DRAWINGS NOT TO SCALE

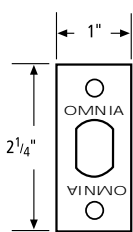

FACEPLATE

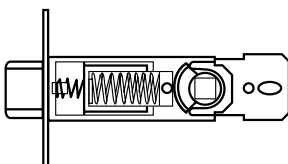

Assembly Detail

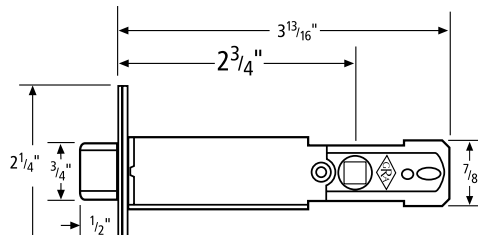
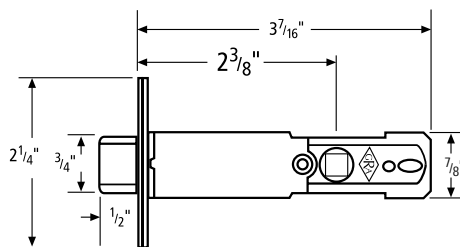

SPECIFY 2 3/8" OR 2 3/4" BACKSET.

NO. 013 "T" STRIKE — STANDARD

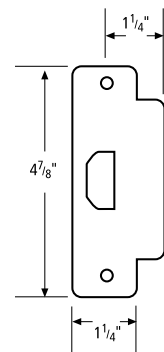
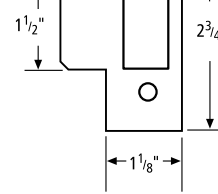

NO. 019 STRIKE — OPTIONAL

NO. 014 "FULL LIP" STRIKE — OPTIONAL

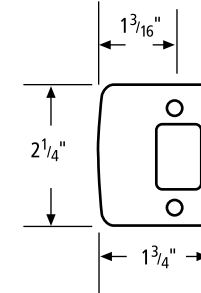

Functions

Passage: Latch operates by knob or lever from either side of door.

Privacy: Latch operates by knob or lever from either side. Spindle locked by privacy block mechanism on inside rose; emergency release on outside rose. For bathroom or bedroom.

Closet Trim: Operated by knob or lever outside and turnpiece inside.

Pair Dummy: Trim on both sides of door. Knob or lever with thru-bolted or concealed screw rose set. (See rose options on page 5).

Single Dummy: Trim on one side of door only. Available for surface mounting or thru-bolting. Knob or lever with rose. (See rose options on page 5).

Dummy applications not recommended for commercial use.



Latchset — Exploded To Show Detail

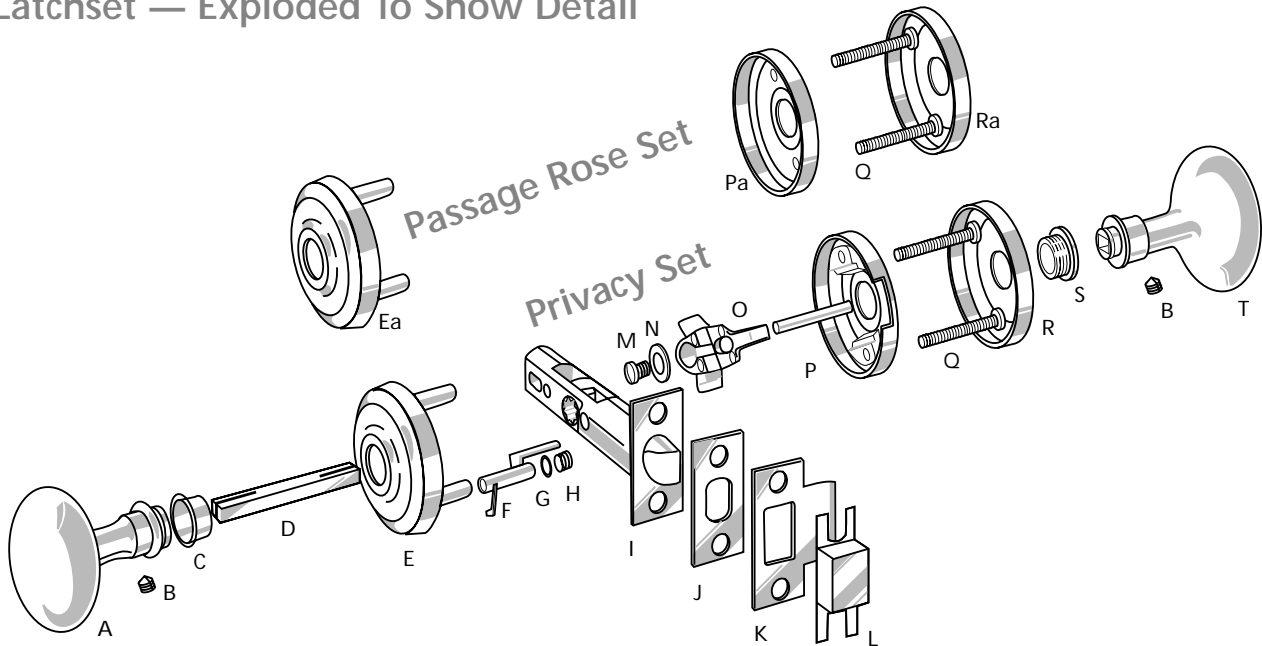

- | | |
|--|---|
| A) Outside Door Knob/Lever Handle | K) Tubular Latch Strike Plate |
| B) Set Screws | L) Tubular Latch Dust Box |
| C) Brass Unthreaded Bushing | M) Privacy Locking Block Fixing Screw |
| D) Spindle (shown upside down to show detail;
for round door knobs the spindle is threaded) | N) Privacy Locking Block Nylon Bushing |
| E) Outside Privacy Rose | O) Privacy Locking Block |
| Ea) Outside Passage Rose | P) Inside Privacy Sub-Rose (Unfinished) |
| F) Emergency Release Arm | Q) Thru-Bolt Screws (2) |
| G) Emergency Release Arm Rubber Washer | R) Inside Privacy Rose (Finished) |
| H) Emergency Release Arm Retainer Spring | Ra) Inside Passage Rose (Finished) |
| I) Tubular Latch | S) Brass Threaded Bushing |
| J) Tubular Latch Faceplate | T) Inside Door Knob/Lever Handle |

Options for Single or Pair Dummy Roses

Single Dummy

1. Surface Mounted — Exposed Screws

A quick, easy, uncomplicated mount when exposed screws are not objectionable. A great way to eliminate sagging levers due to the additional torque that is applied when the hardware is assembled at the factory. This option comes fully assembled.

2. Thru-bolted — Concealed Screws

This is our strongest mounting format as the entire door supports the dummy. The screws are concealed for a clean look on the exterior side. Thru bolt screw heads and decorative washers are visible on the interior side.

Completely factory assembled so that maximum torque is achieved to maintain the proper lever orientation. This method of mounting requires that the door will have to be drilled through for installation.

3. Surface Mounted — Concealed Screws

Also a clean look with no exposed screws. Shipped unassembled, requiring site assembly. The installer needs to achieve proper orientation and sufficient torque on the job site.



Pair Dummy

1. Thru-bolted — Exposed Screws (one side only)

In pair dummy applications, this is the preferred option when exposed screws are not objectionable. Factory assembly affords maximum torque strength insuring lever orientation over time. Installation is quick and uncomplicated.

2. Thru-bolted — Concealed Screws

No screws are exposed in this format. One side is factory assembled, while one side is left unassembled requiring the installer to achieve proper orientation and sufficient torque on the job site.

Single Dummy Options

Exposed

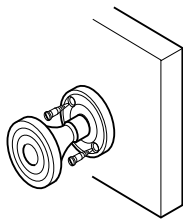

Option 1

Thru-Bolted

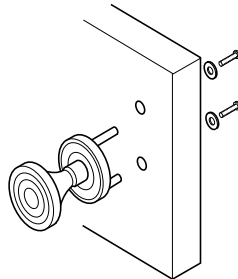

Option 2

Concealed Screws

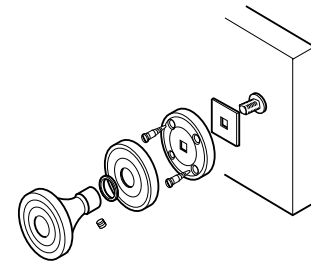

Option 3

Pair Dummy Options

Thru-Bolted

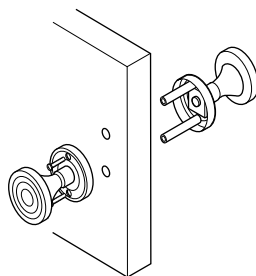

Option 1

Concealed Screws

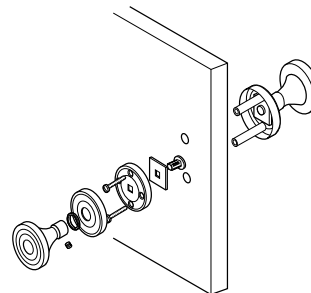

Option 2