

Features

- Acrylic
- For alcove installations
- One-piece construction
- Removable drain cover
- Drain hole at rear
- 60" (152.4 cm) x 42" (106.7 cm) x 4-9/16" (11.6 cm)

ACRYLIC SHOWER RECEPTOR K-9996

ALSO K-9333, K-9337

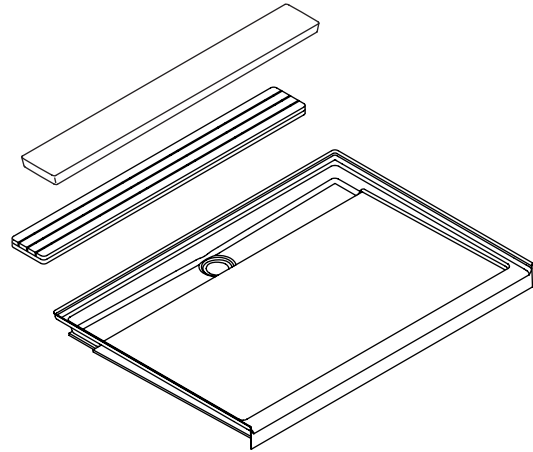

Codes/Standards Applicable

Specified model meets or exceeds the following:

- CSA B45
- IAPMO/cUPC
- ANSI Z124.1.2

Colors/Finishes

- 0: White
- Other: Refer to Price Book for additional colors/finishes

Accessories

- CP: Polished Chrome
- PB: Vibrant® Polished Brass
- SH: Bright Silver
- NA: None applicable
- Other: Refer to Price Book for additional colors/finishes

Specified Model

Model	Description	Colors/Finishes		
K-9996	60" (152.4 cm) receptor	<input type="checkbox"/> 0	<input type="checkbox"/> Other_____	
Required Accessories				
K-9333	Aluminum drain cover OR	<input type="checkbox"/> SH		
K-9337	Teak drain cover	<input type="checkbox"/> NA		
Recommended Accessories				
K-9132	Drain	<input type="checkbox"/> CP	<input type="checkbox"/> PB	<input type="checkbox"/> Other_____
Optional Accessories				
Refer to the Fixtures Price Book for shower door selections, glass options, and color information.				

Product Specification

The acrylic shower receptor with removable drain cover shall be 60" (152.4 cm) in length, 42" (106.7 cm) in width, and 4-9/16" (11.6 cm) in height. Shower receptor shall be for alcove installations. Shower receptor shall be one-piece configuration with drain hole at rear. Shower receptor shall be Kohler Model K-9996-_____.

GROOVE™

Technical Information

Fixture*:	
Weight	72 lbs (32.7 kg)
Configuration	one-piece
Drain hole	3-3/8" (8.6 cm) D.
* Approximate measurements for comparison only.	

Installation Notes

Install this product according to the installation guide.

Shimming may be required to level the fixture.

Shimming may be required between the stud frame and the fixture.

The stud opening tolerance is +1/4" (6 mm), -0" (0 mm).

When fire rated construction is specified, dimensions are to the inside of the fire-rated wall.

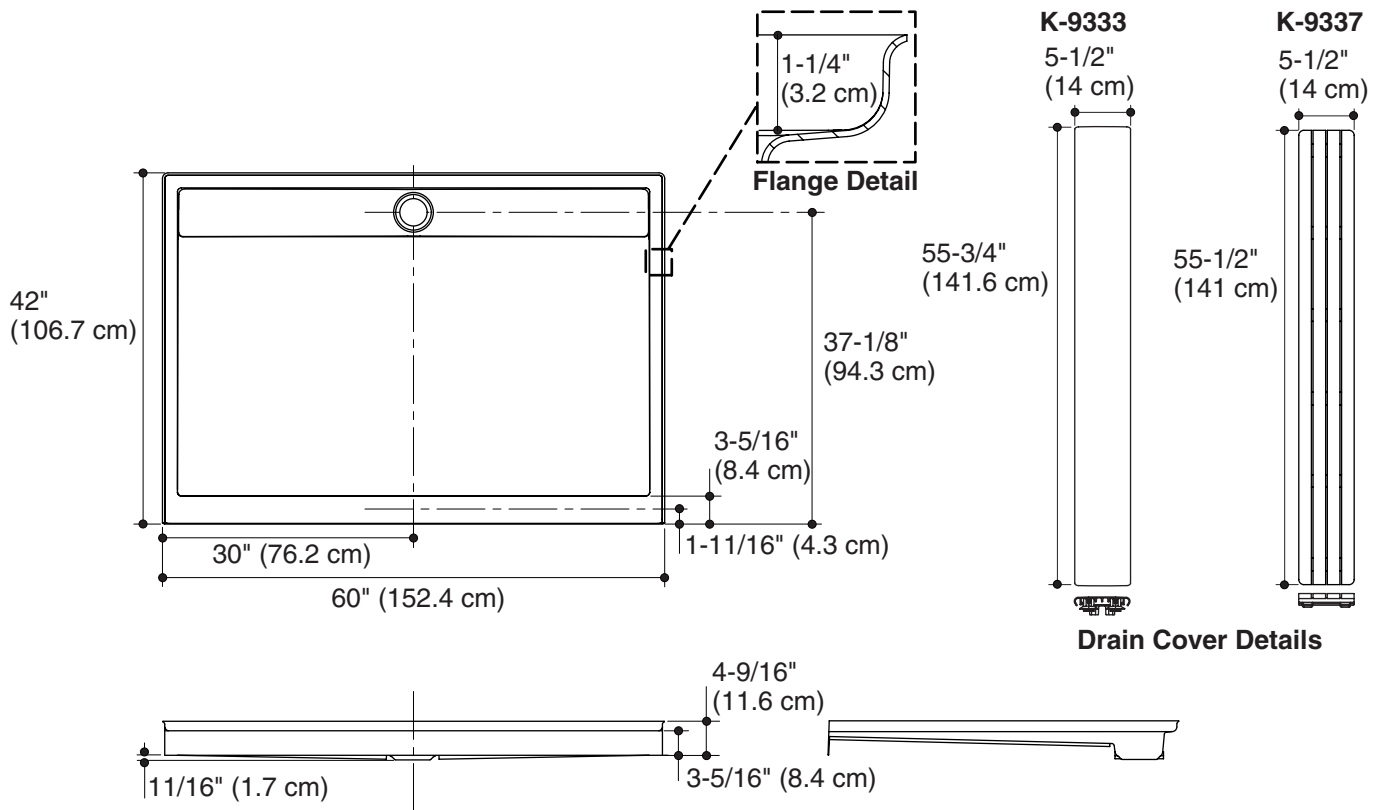

Product Diagram