

**BATH FAUCET TRIM
K-T10585**

Features

- Brass construction
- Bath- or deck-mount
- Lever handle(s)
- Complements Bancroft™ Suite
- 7" (17.8 cm) non-diverter spout with slip-fit connection

Codes/Standards Applicable

Specified model meets or exceeds the following:

- ASME A112.18.1
- CSA B125
- IAPMO/UPC

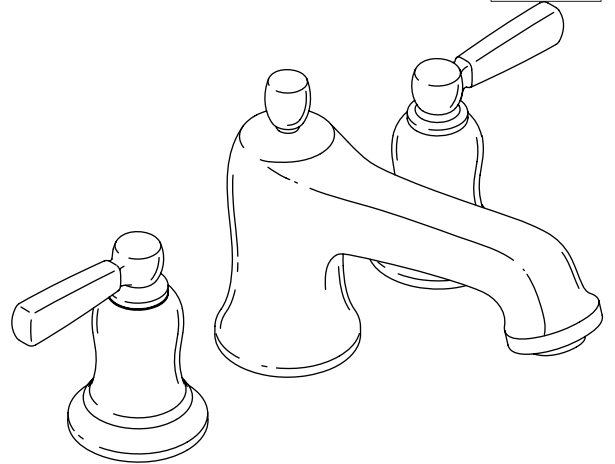

ADA



Colors/Finishes

- CP: Polished Chrome
- PB: Polished Brass
- Other: Refer to Price Book for additional colors/finishes

Specified Model

Model	Description		
K-T10585-4	Metal lever handle deck/bath-mount high-flow bath faucet trim	<input type="checkbox"/> CP <input type="checkbox"/> Other _____	
K-T10585-4P	Ceramic lever handle deck/bath-mount high-flow bath faucet trim		<input type="checkbox"/> CP <input type="checkbox"/> Other _____

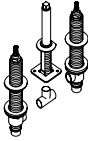
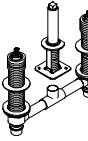
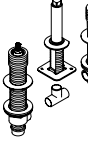
Required Accessory				
K-300-K	1/2" High-flow ceramic disc valve system	<input type="checkbox"/> NA		
K-300-KR	1/2" High-flow ceramic disc valve system, rigid connections		<input type="checkbox"/> NA	
K-301-K	3/4" High-flow ceramic disc valve system			<input type="checkbox"/> NA

Product Specification

Two-handle bath- or deck-mount high-flow bath faucet trim shall be of brass construction. Product shall include a 7" (17.8 cm) non-diverter spout with slip-fit connection. Product shall include lever handles. Faucet trim shall be Kohler Model K-T10585-_____-_____- and valve system shall be Kohler Model K-_____-_____-NA.

BANCROFT™

Technical Information

Applicable faucet trim:		
With metal lever handles	K-T10585-4	
With ceramic lever handles	K-T10585-4P	
Applicable valve:		
1/2" valve system	K-300-K-NA	shown*
1/2" valve system with rigid connections	K-300-KR-NA	not shown*
3/4" valve system	K-301-K-NA	not shown*
* Required for the configuration illustrated.		
Lever handles are ADA compliant		ADA

Installation Notes

Install this product according to the installation guide.

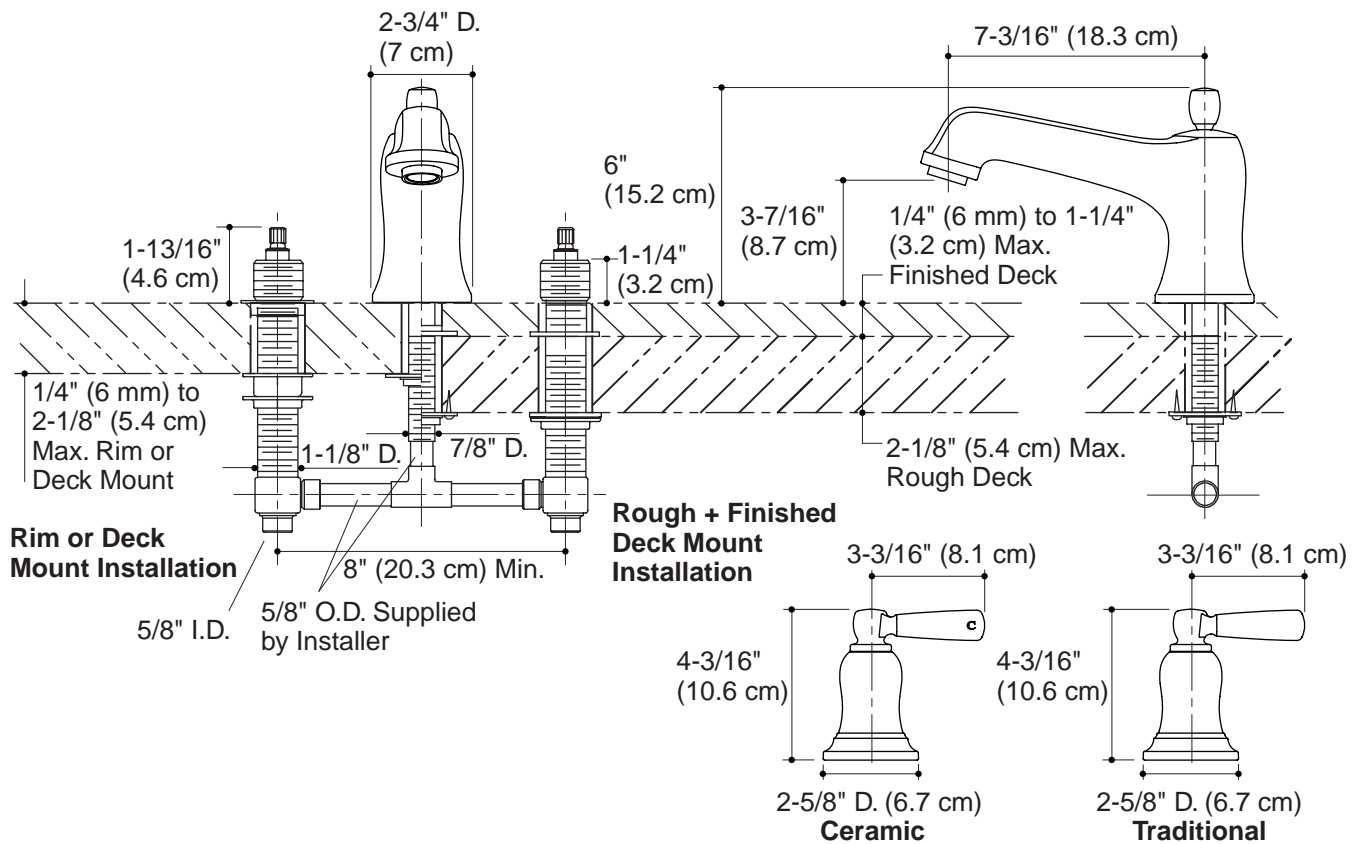

Product Diagram