

Features

- Vitreous china.
- Two-piece toilet.
- Comfort Height® Elongated bowl.
- AquaPiston® flushing system.
- Includes left-hand polished chrome trip lever.
- 1.6 gpf (6.0 lpf).
- 2-1/8" (54 mm) fully glazed trapway.
- 12" (305 mm) rough-in.
- Less seat and supply.
- 11-3/4" (298 mm) x 9-1/2" (241 mm) water area.
- 30-3/8" (772 mm) x 17-13/16" (452 mm) x 31-7/16" (799 mm).
- Floor mount / Floor outlet.

Optional Accessories

- K-9167-L Trip Lever
- K-4650 Toilet Seat
- K-1954 Touchless Toilet Flush Kit
- K-4108 Toilet Seat with Cleansing Functionality
- K-4636 Toilet Seat
- K-4652 Toilet Seat
- K-4659 Toilet Seat
- K-4684 Toilet Seat
- K-4688 Toilet Seat
- K-4694 Toilet Seat
- K-4709 Toilet Seat with Cleansing Functionality
- K-4733 Toilet Seat
- K-4737 Toilet Seat with Cleansing Functionality
- K-4748 Toilet Seat
- K-4774 Toilet Seat
- K-4814 Toilet Seat
- K-4888 Elongated Toilet Seat
- K-5588 Elongated Toilet Seat
- K-7637 Angle Supply with Stop (single)
- K-4712-T Toilet Seat
- K-4761-BN Toilet Seat
- K-4761-CP Toilet Seat

Components

Product includes:

- K-4380 Toilet Bowl
- K-4641 Toilet Tank

Additional included component/s: Tank cover, Trip lever, Bolt cap accessory pack, and Tank accessory pack.



ADA CSA B651 OBC

Codes/Standards







ASME A112.19.2/CSA B45.1
DOE - Energy Policy Act 1992
California Energy Commission (CEC)
ADA
ICC/ANSI A117.1
CSA B651
OBC

KOHLER® One-Year Limited Warranty

See website for detailed warranty information.

Available Color/Finishes

Color tiles intended for reference only.

| Color | Code | Description |
|--|------|--------------|
|  | 0 | White |
|  | 96 | Biscuit |
|  | 47 | Almond |
|  | NY | Dune |
|  | 95 | Ice™ Grey |
|  | G9 | Sandbar |
|  | 7 | Black Black™ |

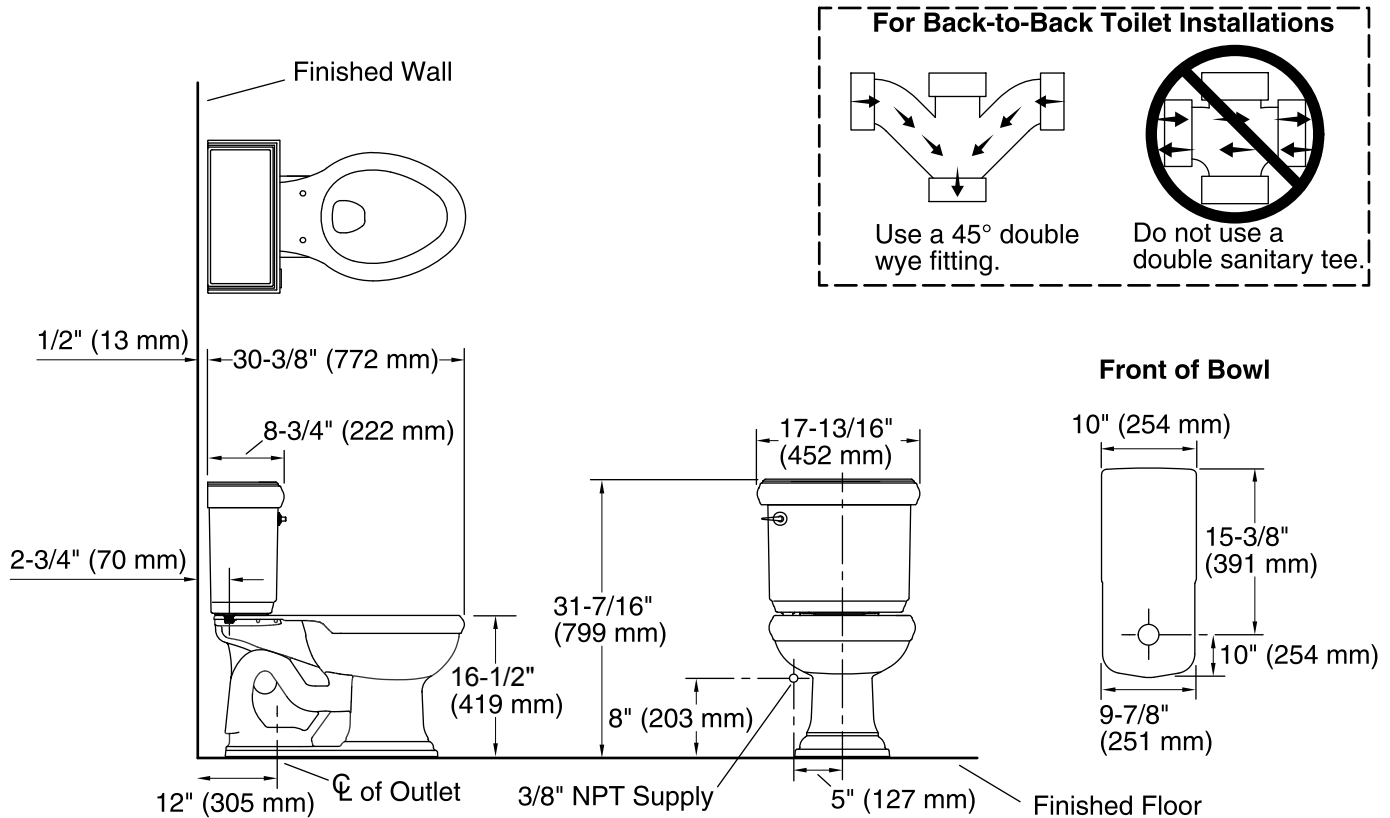

Technical Information

All product dimensions are nominal.

| | |
|-----------------------|------------------------------------|
| Toilet type: | Two-piece, Floor-mount |
| Waste Outlet: | Floor |
| Bowl shape: | Elongated front |
| Flush type: | AquaPiston |
| Trap passageway: | 2-1/8" (54 mm) |
| Water Consumption | |
| Full: | 1.6 gpf (6 lpf) |
| Water surface size: | 11-3/4" x 9-1/2" (298 mm x 241 mm) |
| Rim to water surface: | 6-1/8" (156 mm) |
| Rough-in: | 12" (305 mm) |
| Seat-mounting holes: | 5-1/2" (140 mm) |

Notes

Install this product according to the installation instructions.

For back-to-back toilet installations: Use only a 45° double wye fitting.

ADA, OBC, CSA B651 compliant when installed to the specific requirements of these regulations.

Plumbing Codes require elongated toilets and elongated, open-front toilet seats in public bathrooms.

Accessibility standards require controls to be located on the open side of the toilet.