



Vault™

Top-mount Apron Front Kitchen Sink
K-3944-3

Features

- 36-inch minimum base cabinet width.
- 18-gauge stainless steel.
- Top-mount.
- Double equal bowls.
- Three faucet holes.
- With integral shortened self-trimming apron.
- With SilentShield® sound-absorption technology.
- 35-3/4" (908 mm) x 24-5/16" (618 mm)

Optional Accessories

- K-6429 Utility Rack
- K-6432 Saddle Towel Bar
- K-6434 Saddle Utility Rack
- K-6475 Sink Rack
- K-8801 Sink Strainer

Components

Product includes:

- 1130570 Hardware Kit, Self-Rimming
- 1173293 Hardware Kit, Side Clip



Codes/Standards

ASME A112.19.3/CSA B45.4

Lifetime Limited Warranty for KOHLER® Stainless Steel Sinks

See website for detailed warranty information.

USA/Canada: 1-800-4KOHLER (1-800-456-4537)

Kohler Co. reserves the right to make revisions without notice to product specifications.

For the most current Specification Sheet, go to www.kohler.com.

3-7-2017 07:37

THE BOLD LOOK
OF **KOHLER®**

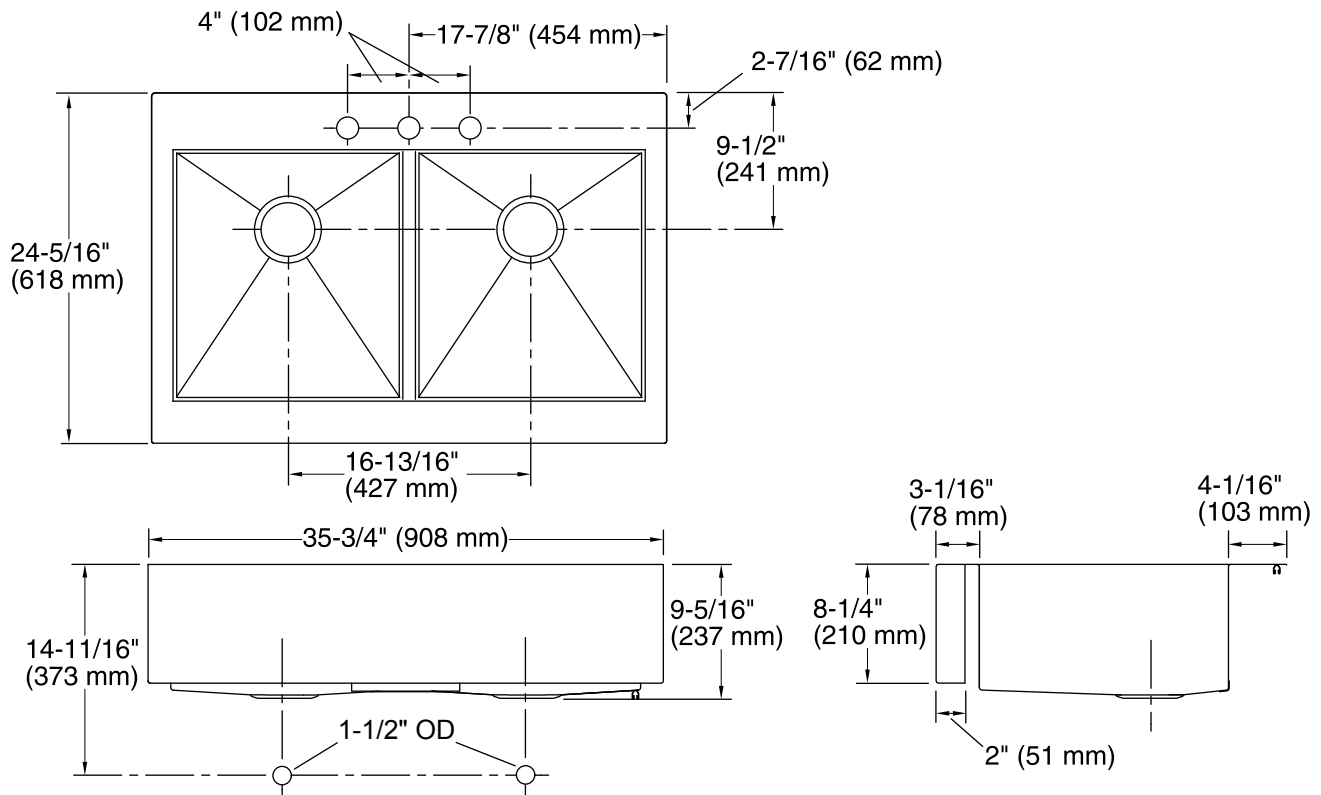

Technical Information

All product dimensions are nominal.

Bowl configuration: Double equal

Installation: Top-mount

Min. base cabinet width: 36" (914 mm)

Bowl area (Left)
Length: 17-3/16" (437 mm)
Width: 15-11/16" (398 mm)
Water depth: 9" (229 mm)

Bowl area (Right)
Length: 17-3/16" (437 mm)
Width: 15-11/16" (398 mm)
Water depth: 9" (229 mm)

Number of deck holes: 3

Faucet hole(s): 1-7/16" (37 mm)

Drain hole: 3-5/8" (92 mm)

Template: 1166717-7, required, included
1178341, required, included

Notes

Install this product according to the installation instructions.