

6' BATH WITH INTEGRAL APRON

K-1259

FEATURES

- 72" x 36" x 20"
- Acrylic
- Left or right outlet
- Integral apron
- Integral tile flange

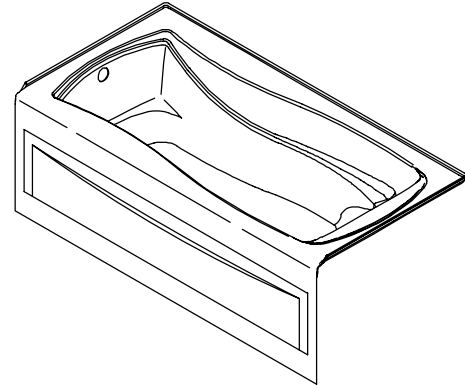

CODES/STANDARDS APPLICABLE

Specified model meets or exceeds the following:

- ANSI Z124.1
- IAPMO/UPC

COLORS/FINISHES

- 0 White
- Other Refer to Fixtures Price Book for additional colors

Accessories:

- CP Polished Chrome
- PB Polished Brass
- Other Refer to Faucets Price Book for additional finishes

SPECIFIED MODEL:

Model	Description	Colors/Finishes	
K-1259-LA	Bath with left outlet, integral apron	<input type="checkbox"/> 0 White	<input type="checkbox"/> Other_____
K-1259-RA	Bath with right outlet, integral apron	<input type="checkbox"/> 0 White	<input type="checkbox"/> Other_____

Recommended Accessories				
K-7166-AF	Drain	<input type="checkbox"/> CP	<input type="checkbox"/> PB	<input type="checkbox"/> Other_____

PRODUCT SPECIFICATION:

The bath shall be 72" in length, 36" in width, and 20" in height. Bath shall be made of acrylic. Bath shall have left or right outlet. Bath shall have integral apron. Bath shall have integral tile flange. Bath shall be Kohler Model K-1259-_____-_____.

MARIPOSA™

PRODUCT INFORMATION

Fixture*:	basin area	top area	weight
Bathing well	50" x 24"	65" x 27"	77 lbs.
	water depth	capacity	
To overflow	14"	72 gal.	
* Approximate measurements for comparison only.			

INSTALLATION NOTES

NOTICE: Unless otherwise specified, floor support under bath must provide for a minimum of 80 lbs./square foot loading.

If installing a rim-mount faucet, make sure any plumbing does not interfere with drain overflow and circulating system before drilling any holes. Consult local and national codes for minimum air gap requirements if installing a spout on the faucet deck.

Roughing-In Notes

No change in measurements if connected with drain illustrated.

Faucet area		recommended
-------------	--	-------------

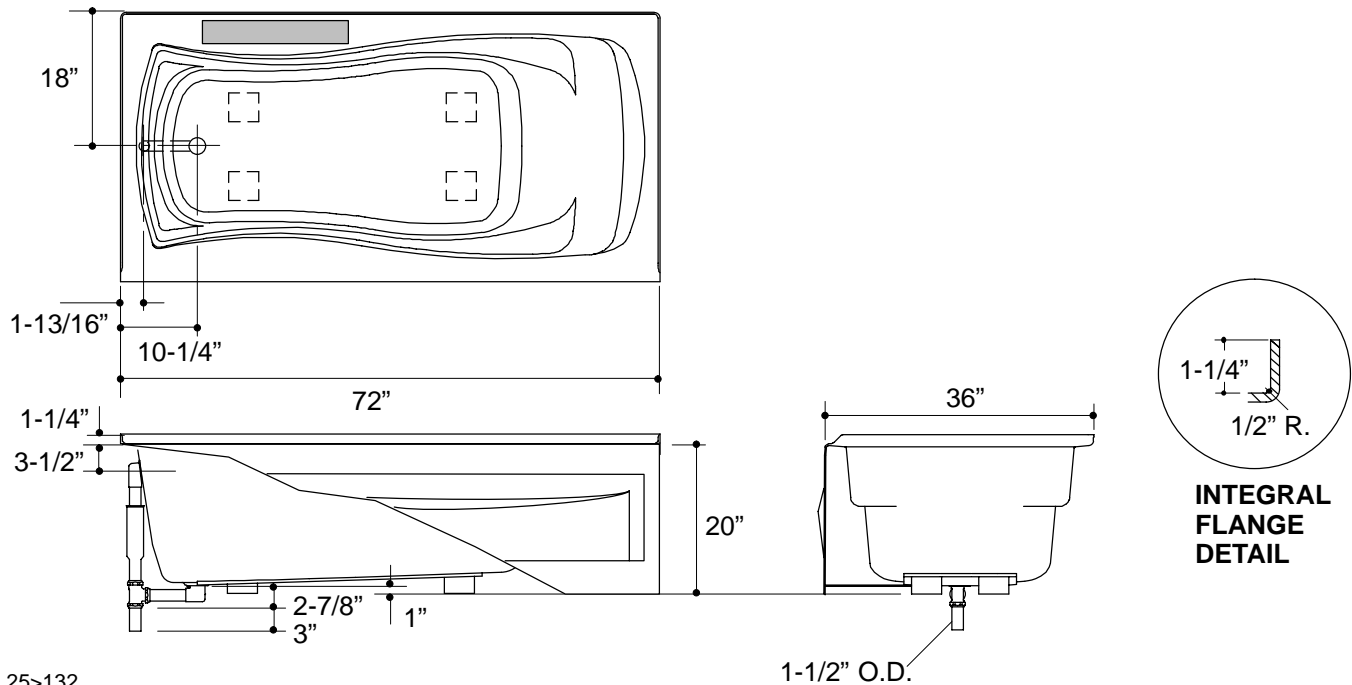

PRODUCT DIAGRAM