

## Features

- Single-function rainhead
- MasterClean™ sprayface features an easy-to-clean surface that withstands mineral buildup
- Optimized sprayface for maximum performance
- 1.75 gpm (6.6 lpm) maximum flow rate

## Material

- Solid-brass construction for durability and reliability

## Technology

- Katalyst® air-induction technology infuses water with air, creating bigger drops for a more powerful spray

## Installation

- 1/2 -14 NPT connection
- Ceiling-mount

## Required Products/Accessories

K-7392 12" ceiling-mount single-function rainhead arm & flange

or

K-7394 6" ceiling-mount single-function rainhead arm & flange

or

K-7396 3" ceiling-mount single-function rainhead arm & flange

## Recommended Products/Accessories

K-23723 Faucet cleaner



## Codes/Standards









ASME A112.18.1/CSA B125.1  
DOE - Energy Policy Act 1992  
EPA WaterSense®  
California Energy Commission (CEC)

## KOHLER® Faucet Lifetime Limited Warranty

See website for detailed warranty information.

## Available Colors/Finishes

*Color tiles intended for reference only.*

Color	Code	Description
	CP	Polished Chrome
	SN	Vibrant® Polished Nickel
	BGD	Vibrant® Moderne Brushed Gold
	BN	Vibrant® Brushed Nickel
	BV	Vibrant® Brushed Bronze
	BL	Matte Black
	2MB	Vibrant® Brushed Moderne Brass
	RGD	Vibrant Rose Gold
	TT	Vibrant Titanium

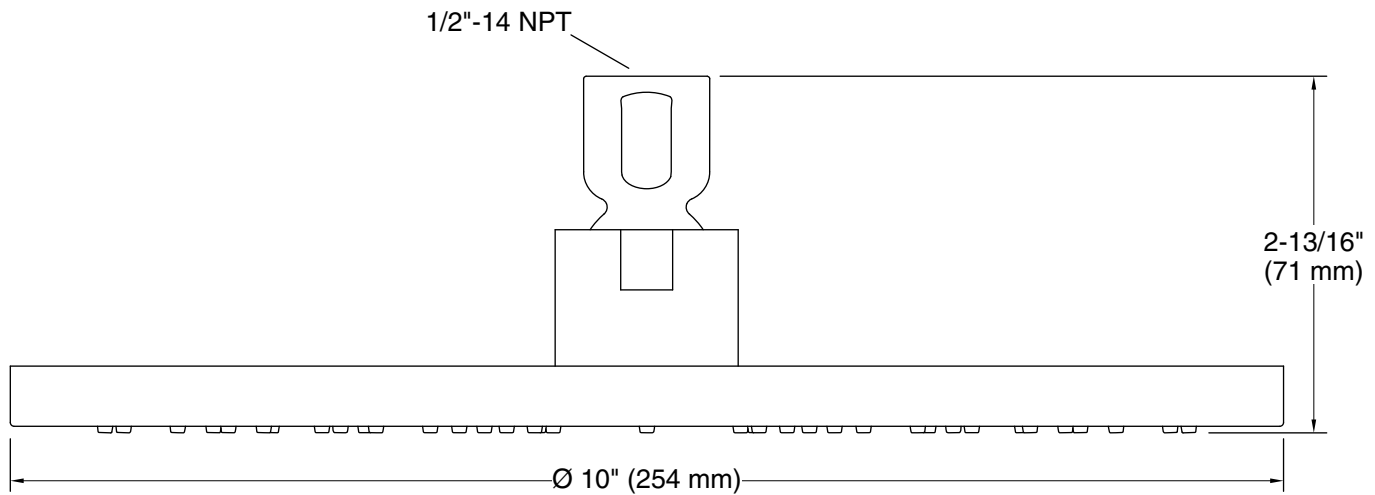

### Technical Information

All product dimensions are nominal.

#### Showerhead/Body Spray:

Rated maximum flow: 1.75 gal/min (6.6 l/min)

flow:

Pressure: 80 psi (5.5 bar)

### Notes

For use with automatic compensating valves rated at 1.4 gal/min (5.3 l/min) or less.

Install this product according to the installation instructions.