

Family: Revere | Item No. 1185 SN

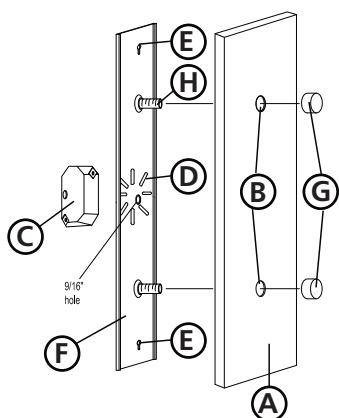

▼ start here

Drawing 1 - Fixture Mounting



Drawing 2 - Fixture Assembly

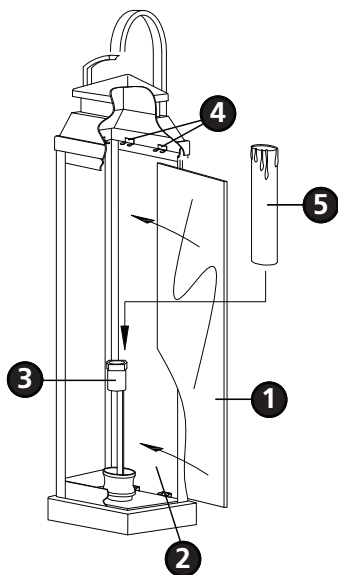

1

1. Find a clear area in which you can work.
2. Unpack fixture and glass from carton.
3. Carefully review instructions prior to assembly.

***** The construction of this fixture will be accomplished by first installing the glass, mounting the mounting strap to the junction box, making all necessary electrical connections, and then mounting the fixture to the wall.**

SAFETY WARNING: READ WIRING AND GROUNDING INSTRUCTIONS (I.S. 18) AND ANY ADDITIONAL DIRECTIONS. TURN POWER SUPPLY OFF DURING INSTALLATION. IF NEW WIRING IS REQUIRED, CONSULT A QUALIFIED ELECTRICIAN OR LOCAL AUTHORITIES FOR CODE REQUIREMENTS.

2

1. To install glass, open side door (not shown on drawing 3) of fixture by lifting up on the small wire tab located on the right side of the fixture when looking at it straight on - see **Drawing 2**.
2. Install small panel of glass (1) on left side of fixture by slipping the glass into the cage through the door opening (2) at a slight angle and around the socket (3) and into position.
3. Fold glass clips (4) located at the top and bottom of the cage so they contact the glass and hold it in position.
4. Repeat procedure for front and back large panels of glass. Starting with the back panel.
5. When all glass panels are installed, the candle sleeve (5) can be slipped over socket (3).
6. Fixture can now be lamped accordingly.

3

1. To prepare fixture for mounting, unthread decorative knobs (G) from front of the backplate (A) and remove retainer plate (F) from the inside of the backplate - see **Drawing 1**.
2. Determine which knockouts (D) will have to be removed to mount retainer plate (F) vertically to the junction box (C).
3. Attach retainer plate (F) to the junction box using screws provided.

Make electrical connections from supply wire to fixture lead wires. Refer to instruction sheet (I.S. 18) and follow all instructions to make all necessary wiring connections. Then refer back to this sheet to continue installation of this fixture.

4

1. Mount the fixture by slipping the holes (B) in the back plate (A) over mounting studs (H), make sure to tuck wires inside backplate carefully making sure not to pinch them - see **Drawing 1**.
2. Hold fixture in position and thread decorative knobs (G) removed earlier to secure fixture.
3. It is recommended to run a bead of silicone around the backplate where it contacts the house in order to seal it from the weather.

Note: Maximum wattage for 1185 fixture is 60 watts per bulb.

5.18.10