

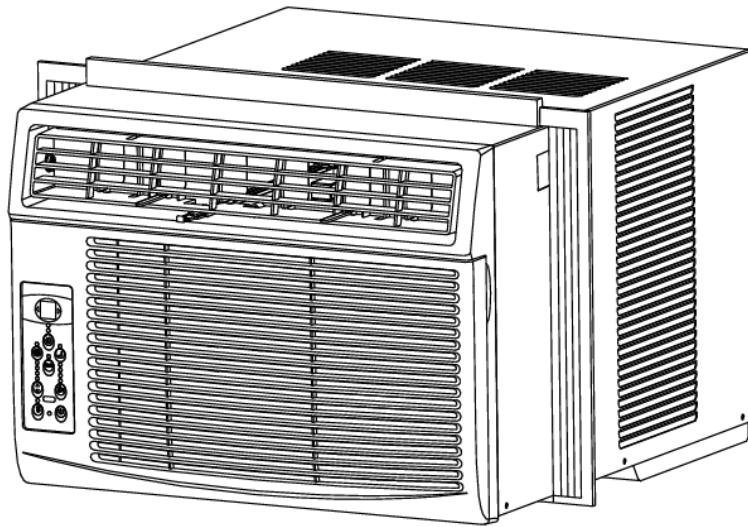

Window Air Conditioner



WAC8002WCO

Owner's Manual

For more information on other great EdgeStar products on the web, go to <http://www.edgestar.com>
To use the EdgeStar self-diagnostic tool, go to <https://support.edgestar.com>

Important Safety Information



Warning: The water produced by the window AC is not potable or suitable for drinking.
Do not drink the water drained from the unit as it contains contaminants and could make you sick.

Improper handling can cause serious damage to the appliance and/or to the user. Please read the following safety information.

Electrical Safety

- Make sure your hands are dry and not wet before operating the unit.
- Do not wet the front housing or control panel.
- Do not directly spray water on this Air Conditioner.
- Do not pull the unit by the cord.
- Always turn the unit off and unplug it from the socket when cleaning.
- Unplug the unit if it is not going to be used for a long period of time.
- Do not operate the unit with a damaged or loose plug and / or socket.
- Use only the correct power supply with appropriate amperage.
- If the power cord is damaged, it must be replaced by the manufacturer, a service agent, or qualified technician.
- Do not turn the unit off or on by inserting or pulling the power plug.
- Do not modify the power cord length or share the outlet with another appliance.
- Do not use this unit with an extension cord and/or adapter plug.
- Do not use this unit near flammable gases/combustibles or in close proximity to heating appliances.
- During operation, do not remove any part of the outside casing.

General Safety

- Do not let people or pets sit or set an object directly in front of air flow.
- If a strange sound, smell, or smoke comes from the unit, turn it off and review the troubleshooting page of this manual.
- Stop operation and unplug the unit in the event of a severe storm.
- To ensure proper air flow and intake, make sure the air vents are not obstructed.
- See instructions for cleaning air filters and how often cleaning should occur.
- Do not use strong detergents when cleaning.
- Children should be supervised when operating this unit.
- Do not allow children to play with the controls or drop any objects into the air outlets or vents.
- Do not place objects or let any person sit on top of the unit.
- Route the power cord carefully to avoid a tripping hazard.
- This unit is intended for domestic home use only. Do not use the window air conditioner for commercial or industrial use. Any other use may invalidate the warranty.
- Use caution when unpacking and installing the unit as there may be some sharp edges.

Operation of Safety Plug



Note: Electrical products should not be disposed of with household waste. Please contact your local recycling center for more information on how to recycle electronic waste.



Your cool-only window air conditioner is supplied with a Leakage-Current Detection and Interruption (LCDI) safety plug. This device provides protection to reduce the risk of fire due to arcing faults in the power supply cord. Before using your window air conditioner, follow the instructions below to ensure that the LCDI plug is working properly:

1. Plug the power cord into a grounded outlet.
2. Press the TEST button on the LCDI plug. This should trip the plug and cut the power to the air conditioner. If the plug does not trip and you are able to turn on the unit, please contact EdgeStar support.

DO NOT USE YOUR COOL-ONLY WINDOW AIR CONDITIONER IF THE TEST FAILS.

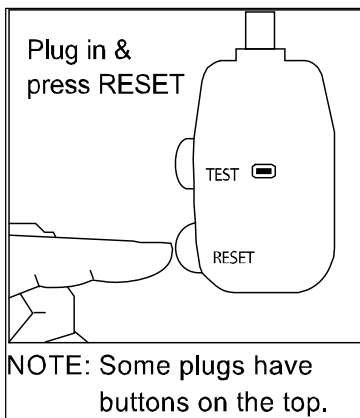

3. Press the RESET button to start using your air conditioner.



Notes:

- Always make sure the “Reset” button is pushed in for proper operation.
- The power supply cord with LCDI plug must be replaced if it fails to reset.
- Do not use the TEST and RESET buttons as an ON/OFF switch.

Table of Contents

IMPORTANT SAFETY INFORMATION	I
OPERATION OF SAFETY PLUG.....	II
TABLE OF CONTENTS	III
INTRODUCTION	1
PARTS IDENTIFICATION	2
FRONT/SIDE VIEW.....	2
PREPARATIONS FOR INSTALLATION	3
TOOLS NEEDED.....	3
PARTS SUPPLIED.....	3
WINDOW INSTALLATION INSTRUCTIONS	4
PREPARING THE UNIT FOR WINDOW INSTALLATION	4
<i>Attaching the Top Channel and Side curtains</i>	4
INSTALLING UNIT INTO WINDOW.....	6
SEALING AIR GAPS.....	9
COMPLETING INSTALLATION.....	10
CONTROL PANEL OPERATIONS	11
USING THE CONTROL PANEL.....	11
<i>To Turn the Unit On</i>	11
<i>To Change the Temperature</i>	11
<i>To Adjust the Fan Speeds</i>	11
<i>To Select Operating Mode</i>	12
<i>To Operate in Auto Mode</i>	12
<i>To Operate in Fan Only</i>	12
<i>To Operate in Dry Mode</i>	12
<i>To Use the Energy Saver Feature</i>	12
<i>To Use the Sleep Feature</i>	12
<i>To Use the Timer (Auto Start/Stop) Feature</i>	13
<i>To Use the Check Filter Feature</i>	13
<i>Digital Display</i>	13
AIR LOUVERS	13
ADDITIONAL TIPS	13
REMOTE OPERATIONS	14
ADDITIONAL NOTES ON REMOTE OPERATIONS	15
MAINTENANCE	16
AIR FILTER CLEANING.....	16
CABINET CLEANING.....	17
NORMAL SOUNDS	17
ERROR CODES	17
ENERGY SAVING GUIDE	17
TROUBLESHOOTING	18
SPECIFICATIONS	20
EDGE STAR LIMITED WARRANTY	21

Introduction

Thank you for purchasing this Koldfront by EdgeStar window air conditioner. We hope that this purchase will be the beginning of a lasting and rewarding relationship between you and EdgeStar. We will provide the customer support and exemplary products necessary to nurture that relationship.

This manual contains important information regarding the proper installation, use and maintenance of your window air conditioner. Following this manual will ensure that your product will work at its peak performance, efficiency, and safety.

Please save the original product packaging in case you need to safely transport your window air conditioner.

For Your Records:

Please write down the model number and serial number below for future reference. Both numbers are located on the ratings label on the back of your unit and are needed to obtain warranty service. You may also want to staple your receipt to this manual as it is the proof of your purchase, and is also needed for service under your warranty.

Model Number: _____

Serial Number: _____

Date of Purchase: _____

For a more efficient experience, please do the following before contacting customer service:

- If you received a damaged product, immediately contact the dealer that sold you the product.
- Read and follow this instruction manual carefully to help you install, use and maintain your window air conditioner.
- Read the troubleshooting section of this manual as it will help you diagnose and solve common issues.
- Visit us on the web at <http://www.edgestar.com> for product guides, additional troubleshooting resources and up-to-date information. You can also find an interactive self-diagnostic tool at <https://support.edgestar.com>. If you need service, our friendly customer service representatives are available via email at service@edgestar.com or by telephone at **1 (866) 319-5473**.

Parts Identification



Caution: Make sure the drain plug is firmly installed before using the unit to prevent leaking.

Front/Side View

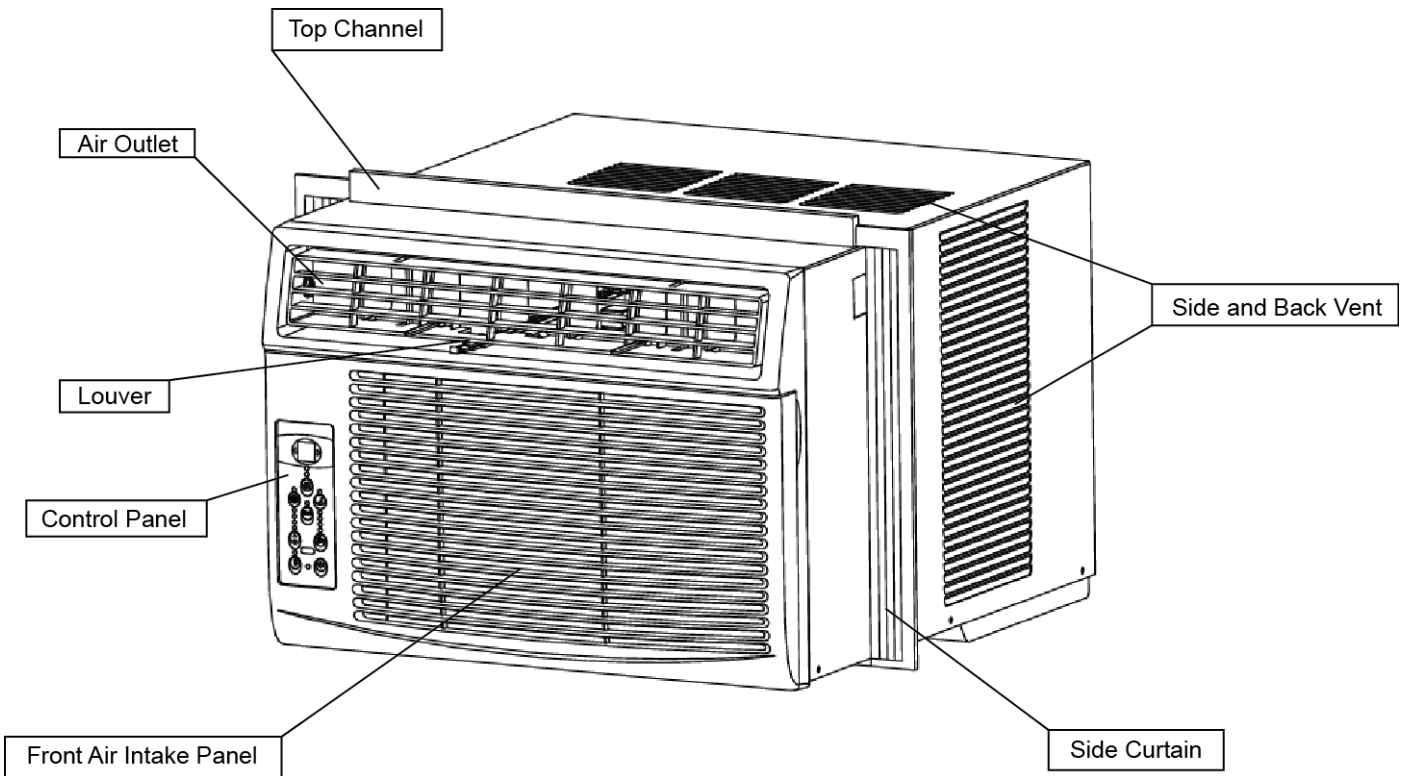

Preparations for Installation



Note: You may need to contact your electrician if your room's circuit is not able to power your unit.



Note: To avoid risk of injury and/or product/property damage, please take the following precautions:

- Two or more people are needed to properly handle and install.
- Use proper lifting and carrying techniques.
- Before installation, make sure to inspect the window and sill to ensure they are able to handle the weight and size of this unit.
- Wearing protective gloves will help to avoid injury from sharp edges.

Before you begin, make sure you have all the parts necessary for installation.

If you have multiple windows, choose one that is near an electrical outlet that will be able to provide sufficient power to your unit. See the power requirements listed on the product label printed on the side or the back of your window air conditioner.

The following measurements are required to properly install the air conditioner.

- Window Width: 23" to 36"
- Window Minimum Height: 14"

Tools Needed

- Philips Screwdriver • Tape Measure • Level • Drill • 1/8" Drill Bit

Parts Supplied

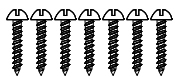

1/2" Phillips Screws (7)



3/8" Phillip Screws (4)

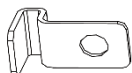

Side Curtain Brackets (2)

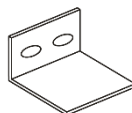

Window Lock Bracket (1)

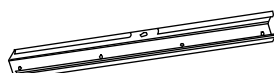

Top Channel (1)

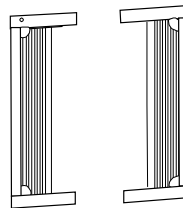

Set of Side Curtains (1)



Window Sash Seal (1)



Weather Stripping (5)



Energy Efficiency
Insulation Panel

Window Installation Instructions



Note: When choosing your window make sure the power supply cord is within 4 feet of a grounded 3-prong outlet.

Please follow all installation instructions to avoid personal injury or damage. It is important that you save all original packaging materials in case you need to safely transport your window air conditioner. Packaging materials must be stored away from children and in a safe manner.



Note: The unit must be installed firmly and securely to prevent excessive noise and vibration.

Preparing the Unit for Window Installation

Attaching the Top Channel and Side curtains

Make sure to attach the top channel and side curtains prior to installing the cabinet into the window.

1. Set the air conditioner unit on a table or other solid work surface.
2. Place the top channel on top of the air conditioner cabinet, lining up the four (4) holes in the top channel with the four (4) holes on top of the cabinet.
3. Use four (4) $\frac{3}{8}$ " Phillips screws to attach the top channel to the top of the cabinet.

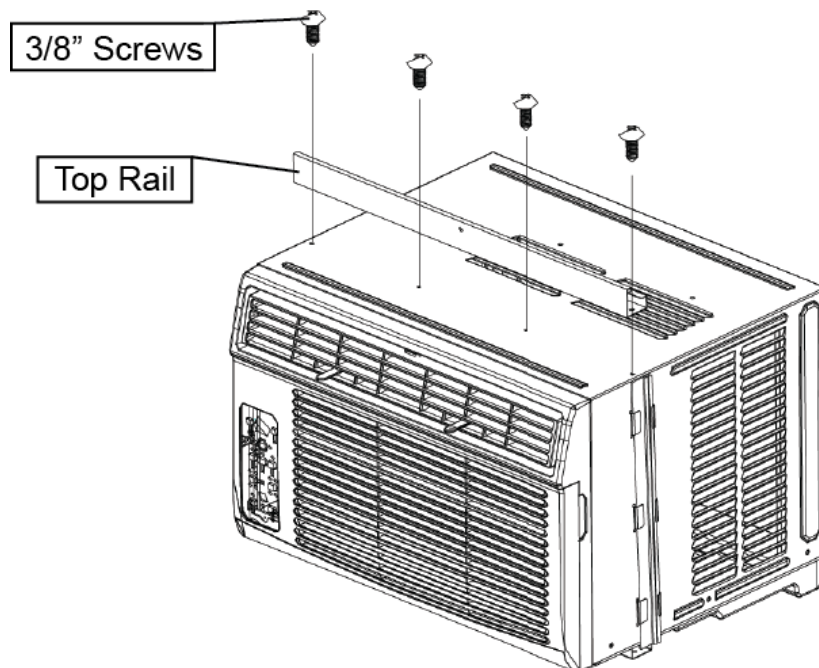

- 4. To attach the side curtains to the air conditioner, start by gently extending the accordion panel until you can insert the open end into the connector tabs located on the side of the unit.

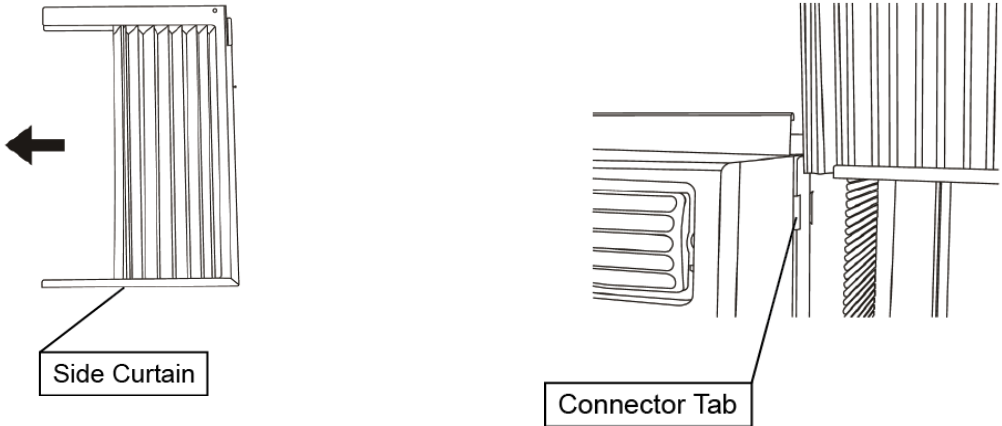

- 5. Insert the top and bottom of the curtain housing into the top curtain and bottom curtain channel.

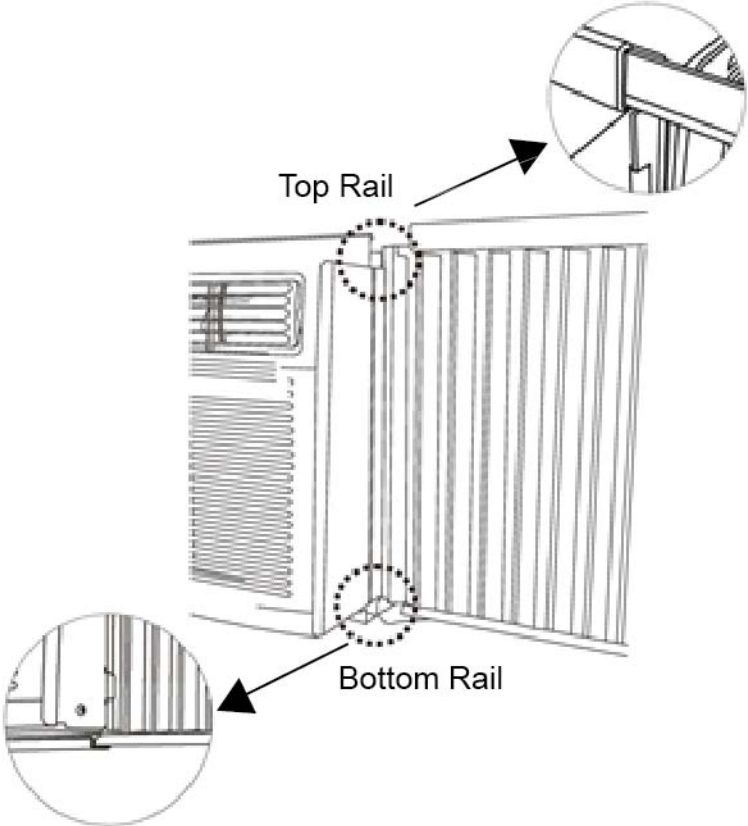

Installing Unit into Window



Note: When choosing your window make sure the power supply cord is within 4 feet of a grounded 3-prong outlet.

Follow the steps listed below to install the air conditioner into the window.

1. Center the air conditioner cabinet into the window:
 - Check that the lower rail of the air conditioner cabinet is behind and against the back side of the window sill.
 - Maintain a firm hold on the cabinet and lower the window sash to hold the cabinet in place.
 - Measure the distance of the right side and left, and adjust until the unit is perfectly centered.

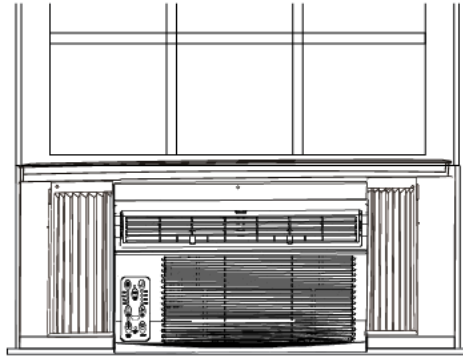

Note: Check that the air conditioner cabinet is tilted back about $1\frac{1}{8}$ " to $1\frac{1}{2}$ ", which should be about 3-4 degrees downward to the outside. After proper installation, condensation should not drain from the overflow drain hole during normal use, correct slope or otherwise.

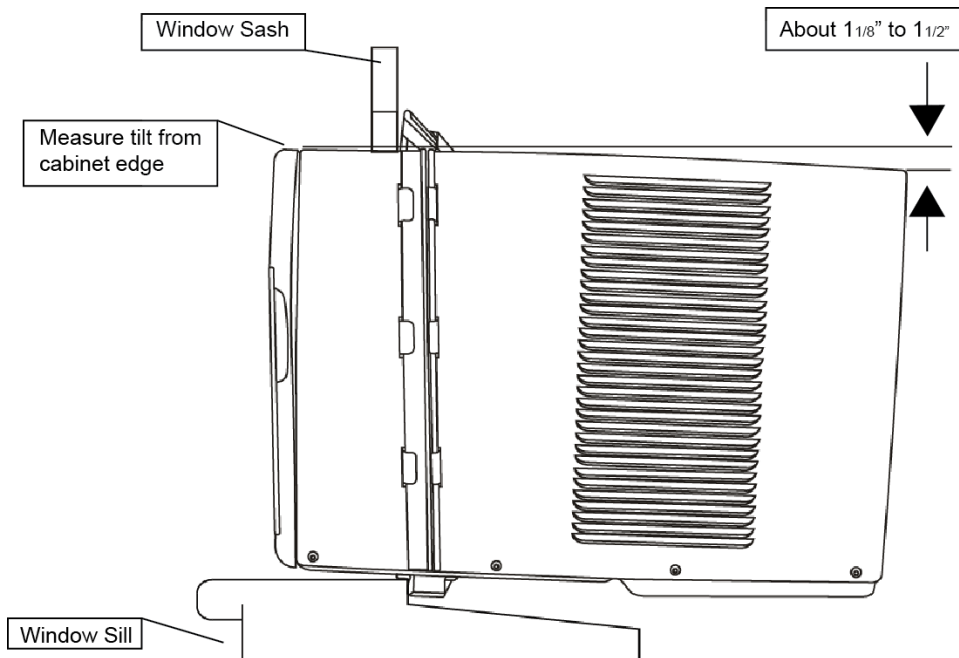

2. Extend both Side Curtains outward until they are flush with the window frame.

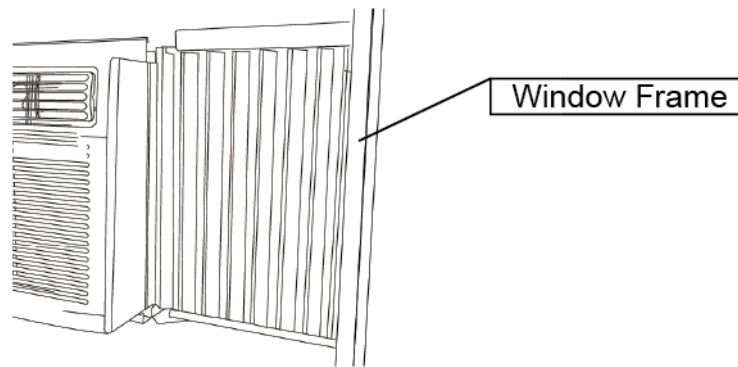

3. Attach Curtain Brackets

- The Curtain Brackets will secure the lower frame of the side curtains to the window sill.
- Place the Curtain Bracket in between the accordion extensions as shown in the image below.
- Use one (1) ½" Philips head screw to attach the Curtain Brackets to the window sill.
- Repeat this procedure for the remaining side curtain.



Note: Use a 1/8" drill bit to drill pilot holes in the window sill to prevent splitting before driving the screws into place.

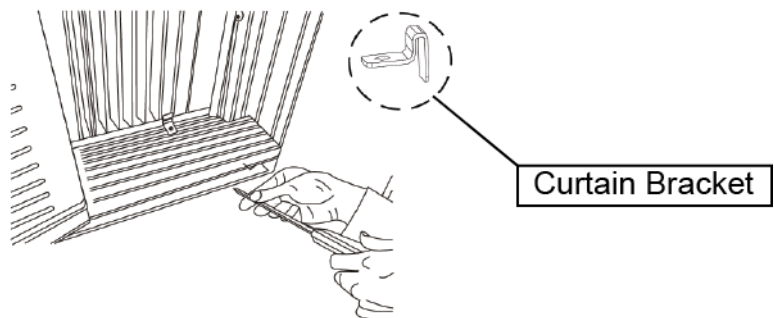

4. Attach Side Curtains to Window Frame

- Use three (3) ½" Philips head screws to attach the side curtain frame and top channel to the window sash.



Note: Use a 1/8" drill bit to drill pilot holes in the window sill to prevent splitting before driving the screws into place.

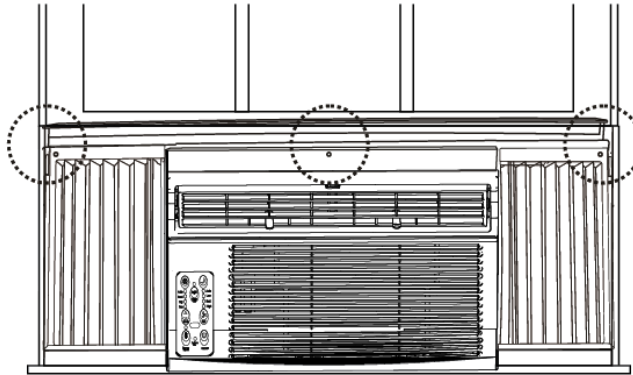

5. Attach Window Lock Bracket

- Secure the lower window sash to the upper window sash with the Window Lock Bracket.
- Use two (2) ½" Philips head screws to attach the bracket to the upper window sash.
- Once installed, the bracket will prevent the lower window sash from being raised upwards.

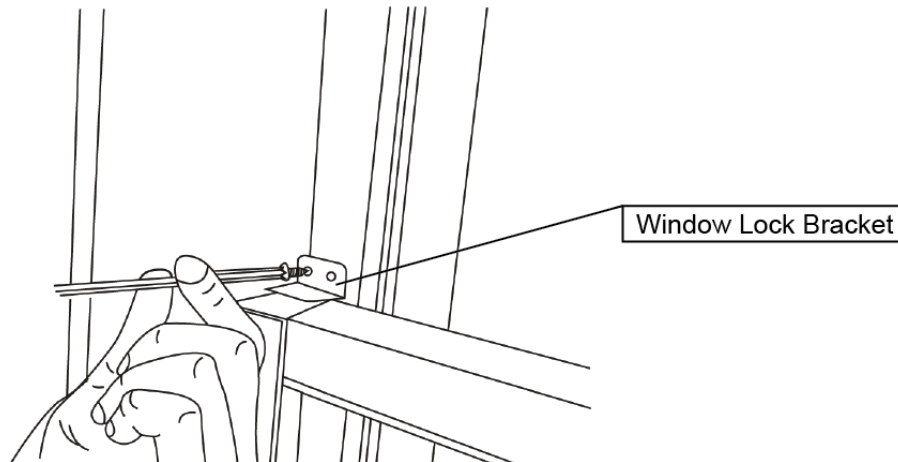

Sealing Air Gaps

1. Install Window Sash Seal

- Trim the window sash seal (foam) to the appropriate length and insert it into the gap that is between the upper and lower window sashes.

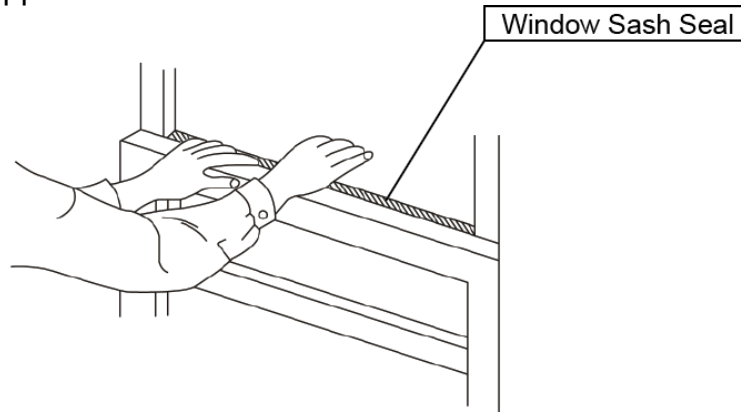

2. Install Energy Efficient Insulation Panels

- This unit comes with insulating sheets that should be installed into each of the side curtains to maximize energy efficiency.
- Start by measuring the inner width of both side curtains.

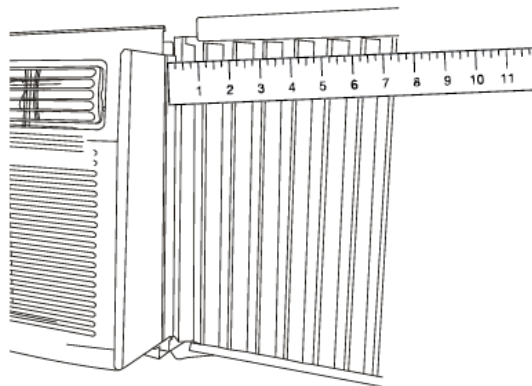

- Locate the insulation panel supplied with this unit and cut each panel to the correct width.
- Slide the insulation panels into each side curtain as shown below with the pattern side facing inward (indoors).

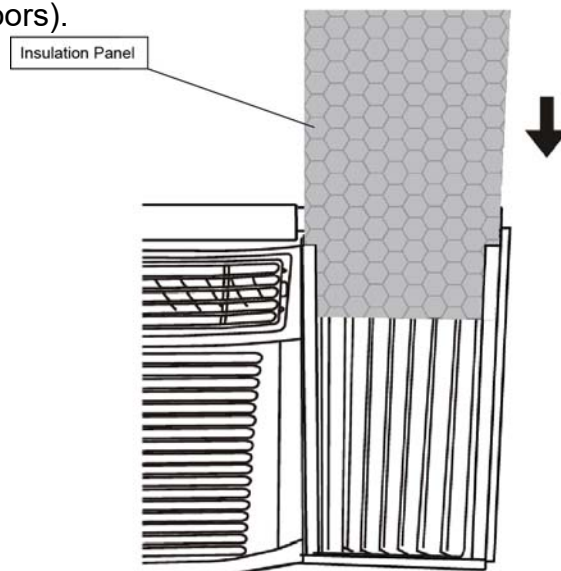

3. Attach Weather Stripping

- In order to minimize air leaks, this unit comes with weather stripping that should be installed as needed to plug any gaps that may be present after you have secured the air conditioner into the window.
- Inspect all of the potential air gaps around the window opening.
- Cut to size and attach weather stripping as needed.

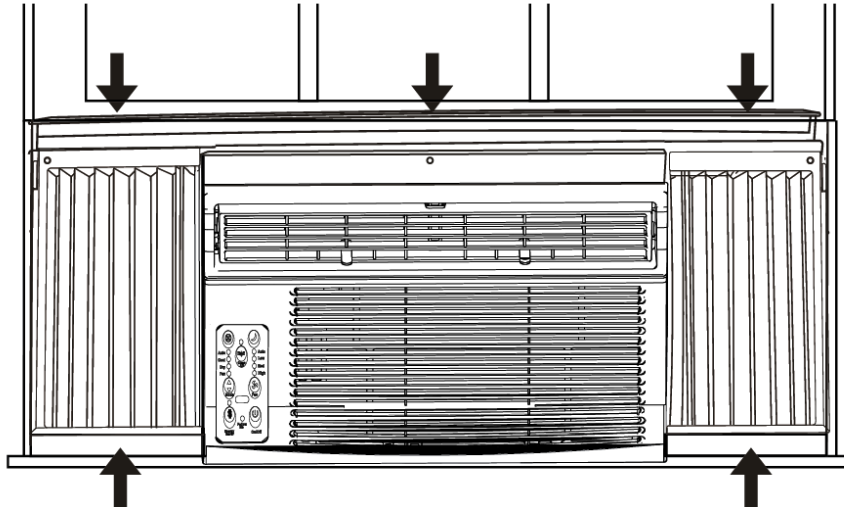

Completing Installation

Now that you have completed the installation steps, your window air conditioner is ready for use.

1. Plug the power cord into a properly grounded 3-prong outlet.
2. Press "Reset" on the LCDI plug.
3. Read the Control Panel Operations section for instructions on all modes and settings for your air conditioner unit.

Control Panel Operations

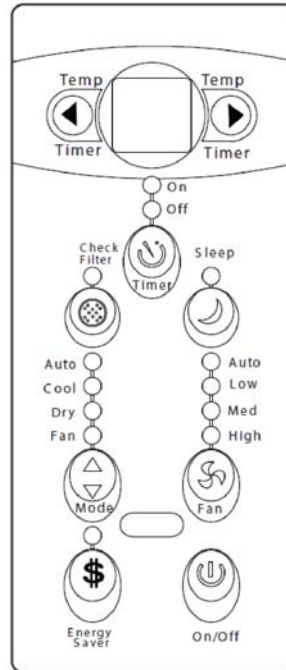
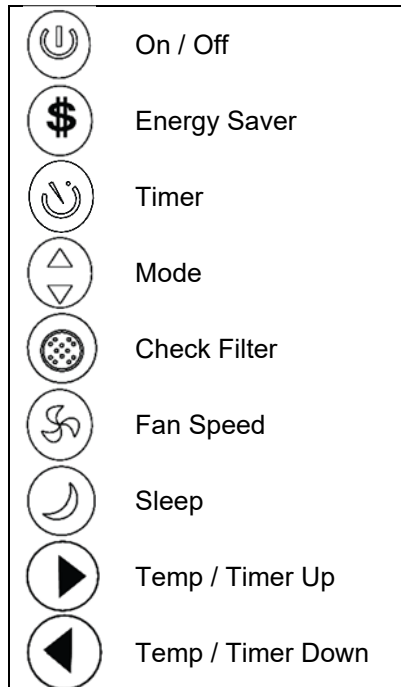

Using the Control Panel

To Turn the Unit On:

Press the On/Off Button .



Note: The Energy Saver feature will automatically turn on in “Cool,” “Dry,” and “Auto” modes.

To Change the Temperature:

Press or hold either Up or Down button until desired temperature is seen on the digital display. This temperature will be automatically maintained anywhere between 62 °F (17°C) and 86°F (30°C). If you want the display to read the actual room temperature, see the “To Operate in Fan Only” section.

To Adjust the Fan Speeds:

To select the speed of the fan press Fan Speed which cycles through four steps- Auto, Low, Medium, and High. Each time the button is pressed the fan speed mode is shifted to the next speed option.



Note: During “Dry mode” the fan speed is set at Low automatically.

To Select Operating Mode:

To choose the operating mode, press the Mode button . Each time you press the button a mode is selected in a sequence that goes from Auto, Cool, Dry, to Fan. The indicator light adjacent to the mode label will be illuminated and remain on once the mode is selected.

To Operate in Auto Mode:

- When you set the unit to “Auto” mode it will automatically select cooling or fan only operation depending on the temperature selected and the current room temperature.
- Once the temperature you selected is achieved, the unit will automatically maintain the room temperature.
- In this mode the fan speed cannot be adjusted. It will start automatically at a speed calibrated to the actual room temperature.

To Operate in Fan Only:

- Use this function only when cooling is not desired, such as for room circulation or to exhaust air (remember to open the vent). You can choose any speed you prefer.
- In this mode, the display will show the actual room temperature as in the cooling mode.
- In Fan Only mode, the temperature is not adjusted.

To Operate in Dry Mode:

In this mode, the air conditioner will operate as a dehumidifier. Because the conditioned space is closed or sealed, some degree of cooling will continue to occur.





To Use the Energy Saver Feature:

To start the Energy Saver feature, press the Energy Saver button . This feature is available on “Cool”, “Dry”, and “Auto”. The fan will continue to run for 3 minutes after the compressor shuts off. The fan then cycles on for 2 minutes at 10 minute intervals until the room temperature is above the set temperature, at which point the compressor turns back on and cooling starts.

To Use the Sleep Feature:

To initiate, press the Sleep button . In this mode the selected temperature will increase by 2°F (1°C) 30 minutes after the mode is selected. The temperature will then increase by another 2°F (1°C) after an additional 30 minutes. This new temperature will be maintained for six (6) hours before it returns to the originally selected temperature. This ends the Sleep mode and the unit will continue to operate as originally programmed. The Sleep Mode program can be cancelled at any time during operation by again pressing the Sleep button.

To Use the Timer (Auto Start/Stop) Feature:

- When the unit is on or off, press the Timer button  and the “Timer On” indicator light will Silluminate. It indicates that the Auto Start program is initiated.
- To switch the timer off press the Timer button  again and the “Timer Off” indicator light will illuminate. It indicates that the Auto Stop program is initiated.
- Press or hold the Up  or Down  button to change the Auto Time by ½ hour increments up to 10 hours, or 1 hour increments thereafter up to 24 hours. The control will count down the time remaining until start.
- The selected time will register in five (5) seconds and the system will automatically revert back to display the previous temperature setting or room temperature when the unit is on.



Note: When the unit is off there is no display.

To Use the Check Filter Feature:

This feature is a reminder to clean the Air Filter for more efficient operation. The LED light will illuminate after 250 hours of operation. To reset the check filter timer and to turn off the Check Filter indicator, simply clean the filter as indicated in the maintenance section of this manual and press Check Filter button .

Digital Display:

Displays the set temperature in °C or °F and the Auto-Timer settings. While in Fan Only mode the display shows the room temperature.

Air Louvers

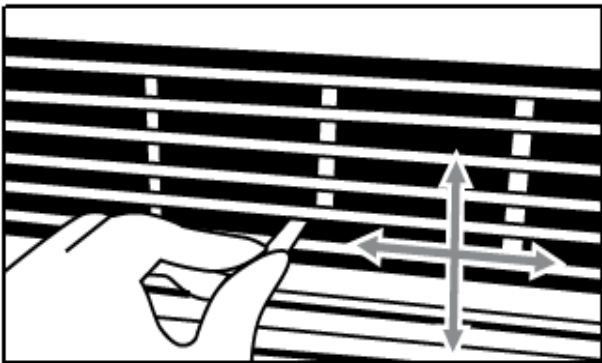

The 4-way air directional louvers allow you to direct the air flow Up, Down, Left, and Right throughout the room as needed. To adjust the air directional louvers side-to-side use the center handles.

Additional Tips:

The “Cool” mode has an automatic three (3) minute timed delay start if the unit is turned off and on quickly. This prevents overheating of the compressor and possible circuit breaker tripping. The fan will continue to run during this time.

The control is capable of displaying the temperature in Fahrenheit or Celsius. To convert from one to the other, press and hold the Up and Down Temp/Timer buttons at the same time for three (3) seconds

Remote Operations

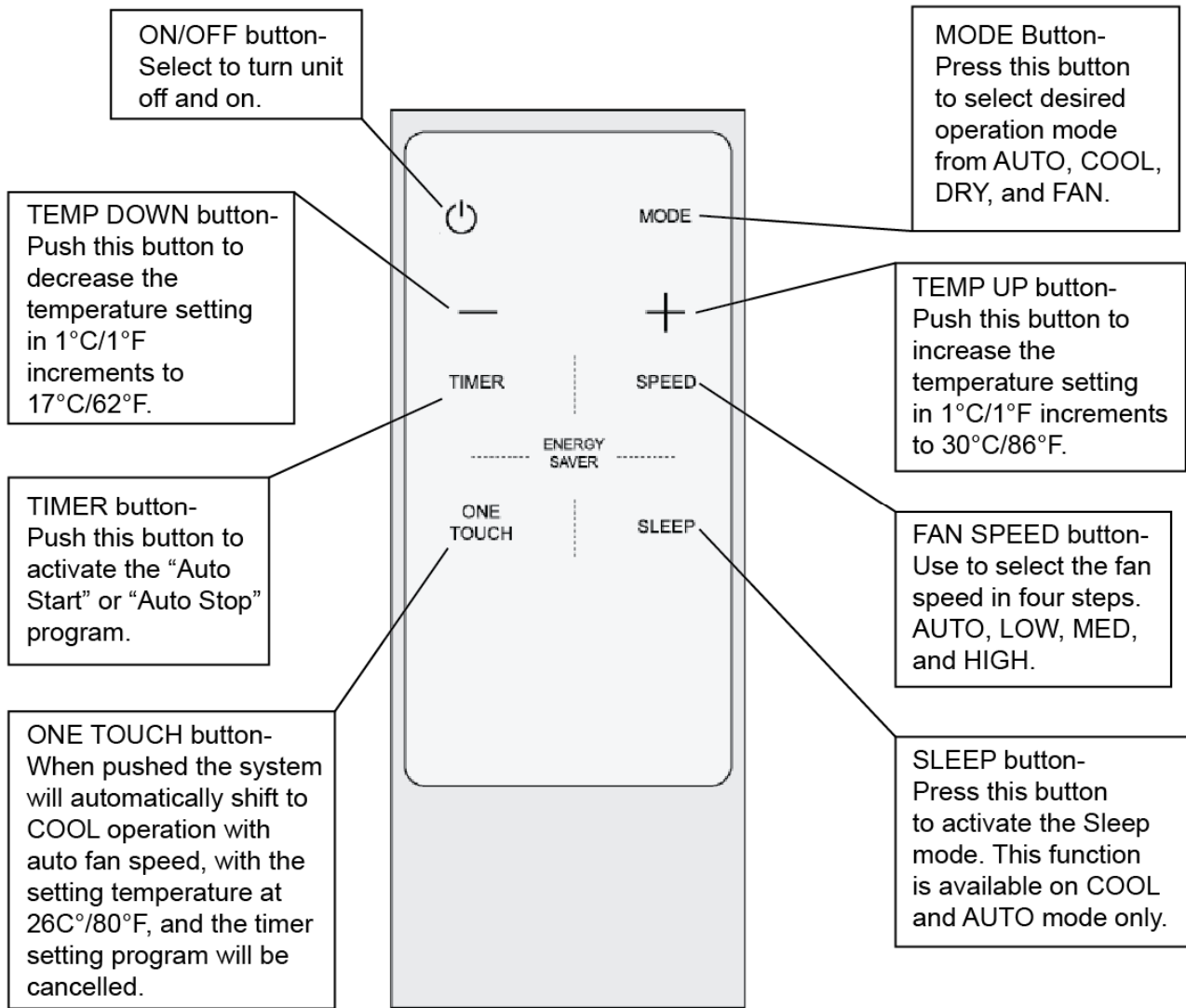

Warning:

- This product contains a lithium button/coin cell battery which is a potential Chemical Burn Hazard. Keep away from children.
- Always completely secure the battery compartment. If the battery compartment does not close securely, stop using the product, remove the batteries, and keep away from children. If a new or used lithium button/coin cell battery is swallowed or enters the body, it can cause severe internal burns and can lead to death in as little as 2 hours. If you think batteries might have been swallowed or placed inside any part of the body, seek immediate medical attention.
- The cells should always be disposed of properly. Even used cells can cause injury.

Additional Notes on Remote Operations

- The remote control has an operating range of 16 ft from the appliance.
- The remote signal receiver/sensor is located on the control panel of the air conditioner.
- Reception of signal commands is confirmed by an audible beep.
- Direct sunlight can interfere with the infrared signal.
- To replace batteries, remove the back cover by pressing where indicated and sliding off the battery cover.

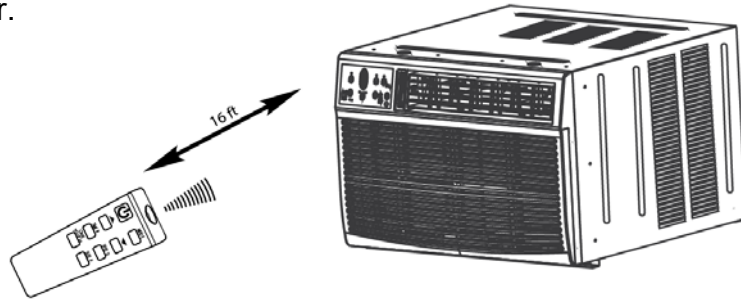

Important:

- The air conditioner will not operate if curtains, doors, or other materials block the signals from the remote control to the unit.
- Do not expose the remote control to direct sunlight or heat or allow any liquid to fall onto it as this could adversely impact its performance.
- If the infrared receiver on the unit is exposed to direct sunlight, the unit may not function properly when operated by the remote control. Use the curtains to prevent sunlight from falling on the infrared receiver.
- If any other electrical appliances react to the remote control, move them away from your air conditioner.



Important:

- This device complies with part 15 of the FCC Rules. Operation subject to the following two conditions: (1) This device may cause harmful interference to other devices, and (2) This device must accept any interference received, including interference that may cause undesired operation.
- This device has been tested and found to comply with the limits for a Class B digital device, pursuant to part 15 of the FCC Rules. These limits are designed to provide reasonable protection against harmful interference in a residential installation. This equipment generates, uses and can radiate radio frequency energy and, if not installed and used in accordance with the instructions, may cause harmful interference to radio communications. However, there is no guarantee that interference will not occur in a particular installation. If this equipment does cause harmful interference to radio or television reception, which can be determined by turning the equipment off and on, the user is encouraged to try to correct the interference by one or more of the following measures:
 - Reorient or relocate the receiving antenna.
 - Increase the separation between the equipment and receiver.
 - Connect the equipment into an outlet on a circuit different from that to which the receiver is connected.
 - Consult the dealer or an experienced radio/TV technician for help.

Maintenance

Clean the air conditioner and filters regularly to maximize performance and efficiency, and prolong the unit's life. Be sure to always unplug the air conditioner from the power outlet before cleaning.

Air Filter Cleaning

The air filter should be checked at least once a month to see if cleaning is necessary. Trapped particles in the filter can build up and potentially cause an accumulation of frost on the cooling coils. After 250 hours of operation, the Check Filter indicator will light up on the control panel as a reminder.

1. Push the vent handle to the "vent closed" position.
2. Open the front panel.
3. Grasp the filter at the center, pull up and out.
4. Wash the filter using liquid dishwashing detergent and warm water. Rinse the filter thoroughly.
5. Gently shake excess water from the filter. Be sure the filter is thoroughly dry before replacing it.
6. You may also gently clean the filter with a vacuum.
7. Reinstall the filter when it is thoroughly dry.
8. Press the Check Filter button on the Control Panel to reset the Check Filter timer.



Warning: Never use hot water over 40°C (104°F) to clean the air filter. Never attempt to operate the unit without the air filter.

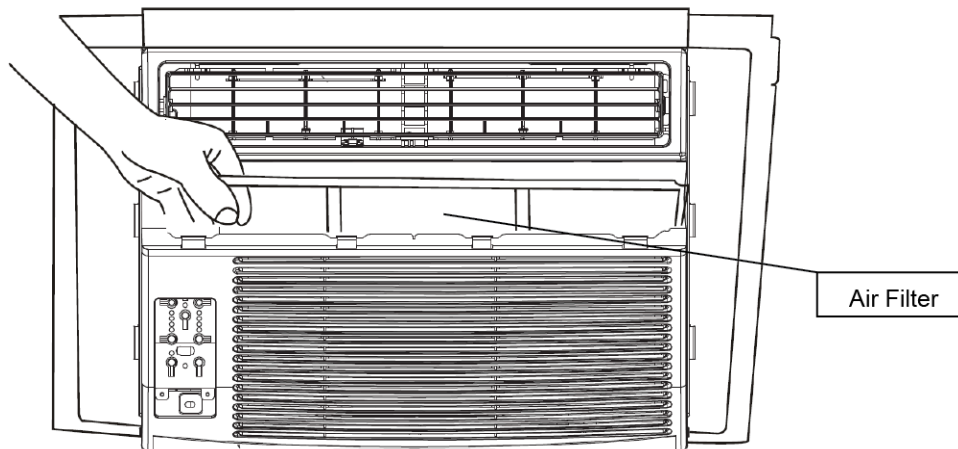

Note: Winter Storage - If you plan to store the air conditioner during the winter, remove it carefully from the window according to the installation instructions. Make sure to clean the unit thoroughly and cover it with plastic or return it to the original carton.

Cabinet Cleaning

- Be sure to unplug the air conditioner to prevent shock or fire hazard. The cabinet and front may be dusted with an oil-free cloth or washed with a cloth dampened in a solution of warm water and mild dishwashing detergent. Rinse thoroughly and wipe dry.
- Never use harsh cleaners, wax, or polish on the cabinet front.
- Be sure to wring excess water from the cloth before wiping around the controls. Excess water in or around the controls may cause damage to the air conditioner.

Normal Sounds

- High Pitched Chatter-High efficiency compressors may have a high pitched chatter during the cooling cycle.
- Sound of Rushing Air-At the front of the unit, you may hear the sound of rushing air being moved by the fan.
- Gurgle/Hiss-Gurgling or Hissing noise may be heard due to refrigerant passing through the evaporator during normal operation.
- Vibration-The unit may vibrate and make noise because of poor wall or window construction or incorrect installation.
- Pinging or Switching-Droplets of water hitting the condenser during normal operation may cause these sounds.

Error Codes

AS-Room temperature sensor error

- Unplug the unit and plug it back in.
- If the error repeats call for service.
- In Fan Only mode it will display “LO” or “HI”

● - Evaporator temperature sensor error

- Unplug the unit and plug it back in.
- If the error repeats, call for service.

Energy Saving Guide

Read and follow the guide below to get the best performance and efficiency from your window air conditioner:

- Do not cover the air outlet (exhaust) while in use.
- Use the timer to operate the unit before it is needed. For example, set the timer to turn on the unit in cooling mode for three (3) or more hours to cool the room before you arrive. You may want to operate the unit all day if you live in a warmer climate.
- Minimize the heat sources (direct sunlight, computers, servers, people, etc.) in the room.
- Close all windows and doors.
- Use the unit in a contained room. For example, a room with four walls and a ceiling, instead of a partitioned studio or warehouse.
- Make sure the unit is secure with no gaps where air can escape.
- Minimize the amount of humidity in the room. Run the unit as a dehumidifier when necessary.
- To prolong the compressor's life, please wait at least three (3) minutes before turning the unit back on after shutting it off.
- Inspect and keep the air filters clean by cleaning regularly.
- Perform routine maintenance.

Troubleshooting

Follow the troubleshooting guide below to resolve common issues.

Issue	Possible Cause	Solution
My air conditioner is not functioning at all.	The wall plug is disconnected.	Make sure the unit is plugged in.
	The LCDI power cord is tripped.	Press the Reset button on the LCDI cord.
	The house fuse is blown or the circuit breaker is tripped.	Replace the fuse with a time delay type or reset circuit breaker.
	The control panel is off.	Turn the control panel ON and set it to your desired setting.
	There is insufficient power.	Move the unit to another outlet. Check your circuit breaker. (Refer to the rating label on the back of the unit to determine the Amperage draw).
The air from the unit does not feel cold enough.	The room temperature is below 17°C (62°F).	Cooling may not occur until the room temperature rises above 17°C (62°F).
	The compressor shut-off by changing modes.	Wait approximately 3 minutes and listen for the compressor to restart when it is set in the COOL mode.
The air conditioner is cooling but the room is too warm. Ice is forming on the cooling coil behind the decorative front.	The outdoor temperature is below 18°C (64°F).	To defrost the coil, set the unit to FAN ONLY mode.
	The air filter may be dirty.	Clean the filter. Refer to the maintenance section. To defrost set the unit to FAN ONLY mode.
	The unit needs to be defrosted.	To defrost the coil, set the unit to FAN ONLY mode. Then, set the temperature to a higher setting.
The air conditioner is cooling but the room is too warm. NO ice is forming on the cooling coil behind the decorative front.	The air filter is dirty and the air is restricted.	Clean the air filter. Refer to the maintenance section.
	The temperature is set too high.	Set the temperature to a lower setting.

Issue	Possible Cause	Solution
The air conditioner is cooling but the room is too warm. NO ice is forming on the cooling coil behind the decorative front.	The air directional louvers are positioned improperly.	Position the louvers for better air distribution.
	The front of the unit is blocked by drapes, blinds, furniture, or other objects that restrict air distribution.	Clear any blockage in front of the unit.
	There are open doors, windows, etc.	When entrances are open cold air escapes. Close doors, windows, etc.
	The unit was recently turned on in a hot room.	Allow additional time to remove "stored heat" from the walls, ceiling, floor, and furniture.
The air conditioner turns on and off rapidly.	The air filter is dirty and the air is restricted.	Clean the air filter.
	The outside temperature is extremely hot.	Set the FAN speed to a higher setting to bring air past the cooling coils more frequently.
There is noise when the unit is cooling.	Some air movement sound is normal.	If the unit is too loud, set it to a slower FAN setting.
	There is window vibration due to poor installation.	Refer to the installation instructions or check with the installer.
There is water dripping INSIDE when the unit is cooling.	The unit was improperly installed.	Tilt the air conditioner slightly to the outside to allow water drainage.
There is water dripping OUTSIDE when the unit is cooling.	The unit is removing a large quantity of moisture from a humid room.	This is normal during excessively humid days.
The remote is not sensing.	The remote control is not located within range of the unit.	Place the remote control within 16 feet and a 180 degrees radius of the front of the unit.
	The remote control signal is obstructed.	Remove the obstruction.
The room is too cold.	The temperature is set too low.	Increase the set temperature.

Specifications

Description of Product	Window Air Conditioner
Model	WAC8002WCO
Voltage/Frequency	115V / 60Hz
Plug Type	LCDI
Power Cord Length	6.5 ft
BTUs (cooling)	8000
Current (cooling)	5.9A
Rated CEER	12.0
Color	White
Coolant	R410A
Timer	24 Hour
Dimensions (Inches) W x D x H	18 ⁹ / ₁₆ " x 17 1/2" x 13 ³ / ₈ "
Net Weight	48.9 lbs

Edgestar Limited Warranty

Full Two-Year Parts and Labor

This product is warranted by EdgeStar and is subject to any conditions set forth as follows:

WHAT IS COVERED:

For a period of TWO (2) YEARS from the date of original retail purchase, EdgeStar will repair or replace any part free of charge, including labor, that fails due to a defect in materials or workmanship. Labor will be performed free of charge at an authorized EdgeStar repair facility and EdgeStar will supply new, rebuilt, or refurbished parts free of charge. EdgeStar may request a defective part be returned in exchange for the replacement part. All replacement parts or products will be new, remanufactured, or refurbished. All products and parts replaced by EdgeStar under warranty service become the property of EdgeStar. After the 24 month period, EdgeStar will no longer be responsible for labor charges incurred or replacement parts. All defective products and parts covered by this warranty will be repaired or replaced on a mail-in basis to an EdgeStar authorized repair facility.

This warranty applies to the original purchaser only, and only covers defects in workmanship experienced during operation of the product under normal service, maintenance, and usage conditions. This warranty applies to the purchase and use of this product in residential settings within the contiguous United States of America.

Exceptions: Commercial or Rental Use Warranty

90 days labor and parts from date of original purchase. No other warranty applies.

WHAT IS NOT COVERED - The following limitations apply to the coverage of this warranty. This warranty does not cover:

- Labor charges for installation, setup, or training to use the product.
- Shipping damage, and any damage caused by improper packaging for shipment to an authorized service center, and any damaged caused by improper voltage or any other misuse, including abnormal service, handling, or usage.
- Cosmetic damage such as scratches and dents.
- Normal wear and tear on parts or replacement of parts designed to be replaced, e.g. filters, cartridges, batteries.
- Service trips to deliver, pick-up, or repair; install the product; or to instruct in proper usage of the product.
- Damages or operating problems resulting from misuse, abuse, operation outside environmental specifications, uses contrary to instructions provided in the owner's manual, accidents, acts of God, vermin, fire, flood, improper installation, unauthorized service, maintenance negligence, unauthorized installation or modification, or commercial use.
- Labor, service, transportation, and shipping charges for the removal and replacement of defective parts, beyond the initial 24 month period.
- Products that have been modified to perform outside of specifications without the prior written permission of EdgeStar.
- Products lost in shipment, or theft.
- Products sold AS IS or from an unauthorized reseller.
- Products with serial numbers that have been removed, defaced, or invalidated.
- Damage from other than normal use.
- Replacement or repair of household fuses, circuit breakers, wiring, or plumbing.
- Damage to personal property from use of product.
- Damage from service other than from an authorized EdgeStar repair facility.
- Hoses, knobs, lint trays and all attachments, accessories, and disposable parts.
- Any service charges not specifically identified as normal such as normal service area or hours.
- Any special or consequential damages arising out of the use of the product.

OBTAINING WARRANTY SERVICE: If you believe your product is defective, contact EdgeStar Customer Support for troubleshooting assistance and warranty service at www.edgestar.com or call 1-866-319-5473. Before contacting Customer Support you are required to have your model number, serial number, and proof of purchase available upon request. Once an EdgeStar authorized representative has confirmed that your product is defective and eligible for warranty service, the product must be returned to an EdgeStar authorized repair facility. EdgeStar is not responsible for damage resulting from shipper mishandling or improper packaging. Do not return a defective product to the place of purchase. Products received without a return authorization number will be refused.

THIS WARRANTY IS IN LIEU OF ANY OTHER WARRANTY, EXPRESS OR IMPLIED, INCLUDING WITHOUT LIMITATION, ANY WARRANTY OF MERCHANTABILITY OR FITNESS FOR A PARTICULAR PURPOSE. TO THE EXTENT ANY IMPLIED WARRANTY IS REQUIRED BY LAW, IT IS LIMITED IN DURATION TO THE EXPRESS WARRANTY PERIOD ABOVE. NEITHER THE MANUFACTURER NOR ITS DISTRIBUTORS SHALL BE LIABLE FOR ANY INCIDENTAL, CONSEQUENTIAL, INDIRECT, SPECIAL, OR PUNITIVE DAMAGES OF ANY NATURE, INCLUDING WITHOUT LIMITATION, LOST REVENUES OR PROFITS, OR ANY OTHER DAMAGE WHETHER BASED IN CONTRACT, TORT, OR OTHERWISE. IN NO EVENT AND UNDER NO CIRCUMSTANCE OF ANY TYPE OR KIND SHALL THE SELLER, MANUFACTURER, AND/OR DISTRIBUTOR BE LIABLE FOR ANY REASON, UNDER ANY THEORY, FOR MORE THAN THE BASIC COST OF THE PRODUCT TO THE PURCHASER OR END USER. SOME STATES DO NOT ALLOW THE EXCLUSION OF INCIDENTAL OR CONSEQUENTIAL DAMAGES, SO THE ABOVE EXCLUSION MAY NOT APPLY TO YOU. THIS WARRANTY GIVES YOU SPECIFIC LEGAL RIGHTS. YOU MAY HAVE OTHER RIGHTS THAT VARY FROM STATE TO STATE.