

INSTALLATION MANUAL FOR TCGG MODELS (CURVED GLASS DELI CASE)



TCGG-48-S



TCGG-72-S

TABLE OF CONTENTS

► **Safety Information**

Safety Precautions	1
Proper Disposal	2
Connecting Electricity	4
Adapter Plugs	4

► **Installation / Operation Instructions**

Ownership	4
Required Tools	4
Uncrating	4
Location	5
Leveling Cabinet	5
Defrost Timer Instructions (Grasslin Timer)	6
Conductors and Circuits	7
Electrical Instructions & Start-up	8
Sealing the Cabinet to the floor	9
Shelving Installation & Operation	9-10

► **Maintenance, Care & Cleaning**

Temperature Control Adjustment	11
Cleaning Condenser Coil	12-13
Stainless Steel Equipment Care & Cleaning	14-15
Light Bulb Replacement	15
Warranty (U.S.A. & CANADA ONLY!)	16

*Spanish, German, and French versions included.

CONGRATULATIONS!

You have just purchased the finest commercial refrigeration available. You can expect many years of trouble-free operation.

TCGG MODELS (CURVED GLASS DELI CASE)

NOTICE TO CUSTOMER:



**Loss Or Spoilage Of Products
In Your Refrigerator/Freezer
Is NOT Covered By Warranty.
In Addition To Following
Recommended Installation
Procedures You Must Run
The Refrigerator/Freezer
24 Hours Prior To Usage.**

True Manufacturing Company, Inc.

SAFETY INFORMATION

How to Maintain Your *TRUE*® Unit to Receive the Most Efficient and Successful Operation

You have selected one of the finest commercial refrigeration units made. It is manufactured under strict quality controls with only the best quality materials available. Your TRUE cooler, when properly maintained, will give you many years of trouble-free service.

WARNING!

Use this appliance for its intended purpose as described in this Owner Manual.

SAFETY PRECAUTIONS

When using electrical appliances, basic safety precautions should be followed, including the following:

- This refrigerator must be properly installed and located in accordance with the Installation Instructions before it is used.
- Do not allow children to climb, stand or hang on the shelves in the refrigerator. They could damage the refrigerator and seriously injure themselves.
- Do not touch the cold surfaces in the refrigerated compartment when hands are damp or wet. Skin may stick to these extremely cold surfaces.
- Do not store or use gasoline or other flammable vapors and liquids in the vicinity of this or any other appliance.
- Keep fingers out of the “pinch point” areas; clearances between the doors and cabinet are necessarily small; be careful closing doors when children are in the area.

NOTE

We strongly recommend that any servicing be performed by a qualified individual.

- Unplug the refrigerator before cleaning and making repairs.
- Setting temperature controls to the 0 position does not remove power to the light circuit or evaporator fans.

SAFETY INFORMATION

DANGER!
RISK OF CHILD ENTRAPMENT

PROPER DISPOSAL OF THE REFRIGERATOR

Child entrapment and suffocation are not problems of the past. Junked or abandoned display cases are still dangerous... even if they will sit for “just a few days.” If you are getting rid of your old display case, please follow the instructions below to help prevent accidents.

Before You Throw Away Your Old Refrigerator or Freezer:

- Take off the doors.
- Leave the shelves in place so that children may not easily climb inside.

Refrigerant Disposal

Your old refrigerator may have a cooling system that uses “Ozone Depleting ” chemicals. If you are throwing away your old refrigerator, make sure the refrigerant is removed for proper disposal by a qualified service technician. If you intentionally release any refrigerants you can be subject to fines and imprisonment under provisions of the environmental regulations.

USE OF EXTENSION CORDS

NEVER USE AN EXTENSION CORD! TRUE will not warranty any display case that has been connected to an extension cord.

SAFETY INFORMATION

WARNING!

HOW TO CONNECT ELECTRICITY

*Do not, under any circumstances, cut or remove the ground prong from the power cord.
For personal safety, this appliance must be properly grounded.*

The power cord of this appliance is equipped with a grounding plug which mates with a standard grounding wall outlet to minimize the possibility of electric shock hazard from this appliance.

Have the wall outlet and circuit checked by a qualified electrician to make sure the outlet is properly grounded.

If the outlet is a standard 2-prong outlet, it is your personal responsibility and obligation to have it replaced with the properly grounded wall outlet.

The unit should always be plugged into it's own individual electrical circuit, which has a voltage rating that matches the rating plate.

This provides the best performance and also prevents overloading building wiring circuits which could cause a fire hazard from overheated wires.

Never unplug your freezer by pulling on the power cord. Always grip plug firmly and pull straight out from the outlet.

Repair or replace immediately all power cords that have become frayed or otherwise damaged. Do not use a cord that shows cracks or abrasion damage along its length or at either end.

When removing the freezer away from the wall, be careful not to roll over or damage the power cord.

USE OF ADAPTER PLUGS

NEVER USE AN ADAPTER PLUG! Because of potential safety hazards under certain conditions, we strongly recommend against the use of an adapter plug.

NEMA plugs
TRUE uses these types of plugs.
If you do not have the right outlet
have a certified electrician install
the correct power source.

 115/60/1
NEMA-5-15R

 115/60/1
NEMA-5-20R

INSTALLATION / OPERATION INSTRUCTIONS

INSTALLATION / OPERATION INSTRUCTIONS

OWNERSHIP

To ensure that your unit works properly from the first day, it must be installed properly. We highly recommend a trained mechanic and electrician install your TRUE equipment. The cost of a professional installation is money well spent.

Before you start to install your TRUE unit, carefully inspect it for freight damage. If damage is discovered, immediately file a claim with the delivery freight carrier.

TRUE is not responsible for damage incurred during shipment.

REQUIRED TOOLS

- Adjustable Wrench
- Phillips Head Screwdriver
- Level

UNCRATING

The following procedure is recommended for uncrating the unit:

A. Remove the outer packaging, (cardboard and bubbles or styrofoam corners and clear plastic). Inspect for concealed damage. Again, immediately file a claim with the freight carrier if there is damage.

B. Move your unit as close to the final location as possible before removing the wooden skid.

NOTE

Keys for coolers with door locks are located in warranty packets.

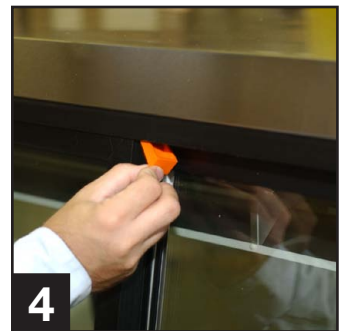
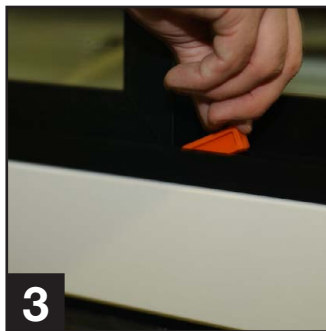

INSTALLATION / OPERATION INSTRUCTIONS

LOCATING

- A.** Remove packing material behind cabinet as a cushion. Carefully lay the unit on its back to remove skid.

When lifting unit remember to leave the cabinet upright for 24 hours before plugging into power source.

- B.** Remove skid by unscrewing all base rail anchor brackets. Place skid to the side.
- C.** Carefully lift cabinet upright.

Removing skid from bottom of cabinet.



LEVELING

- A.** For proper performance of refrigerated cabinet an ambient temperature no greater than 75°F (24°C) with a relative humidity of 55% is required.
- B.** Proper leveling of your TRUE deli case is critical to operating success. Effective condensate removal and door operation will be effected by leveling.
- C.** The deli case should be leveled front to back and side to side with a level (see figure 1). Place the level in the interior floor of the unit in the four positions illustrated. (See figure 2).
- D.** If the cabinet is not level adjust leg levelers by first relieving weight to leveler and adjusting by either hand or wrench. Repeat with all leg levelers until cabinet is level in all directions.

- E.** Ensure that the drain hose or hoses are positioned in the condensate pan. (See Figure 1).
- F.** Free plug and cord from inside the lower rear louver of the cooler (do not plug in). (See figure 1).
- G.** The deli case should be placed close enough to the electrical supply so that extension cords are never used.

WARNING

Cabinet warranties are void if OEM power cord is tampered with. TRUE will not warranty any units that are connected to an extension cord.

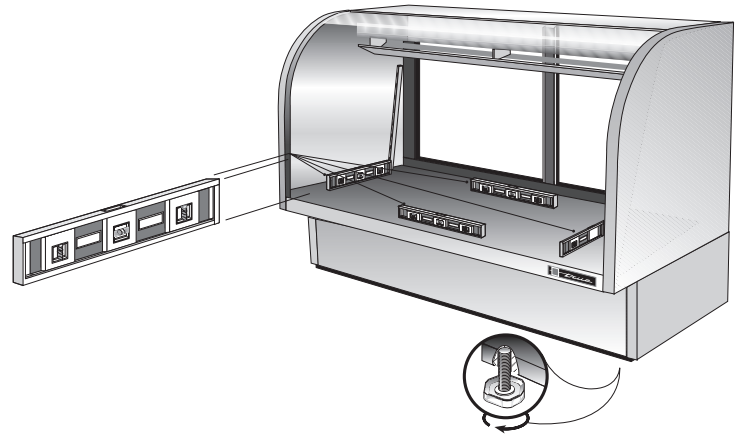
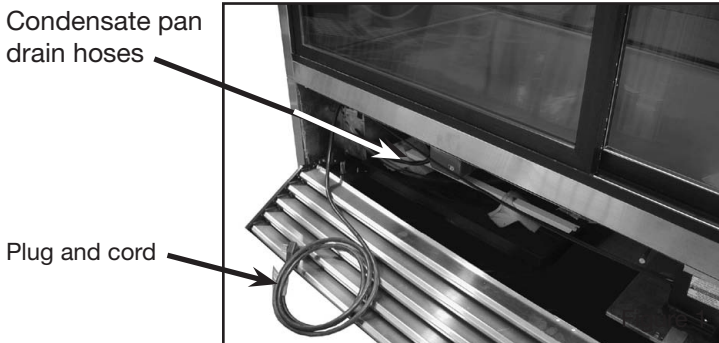

REMOTE UNITS (This section applies to remotes only!)

- Remote cabinets must be ordered as remote. We do not recommend converting from a standard self contained to remote system.
- All remote cabinets must be hard wired.
- No castors available.
- All remote cabinets come standard using 404A refrigerant.
- All remote units come standard with expansion valve, liquid line solenoid, heated condensate pan, and defrost timer when applicable.

- Contact TRUE Technical Service for BTU requirements.
- No wiring necessary between cabinet and condensing unit.
- All remote condensing units purchased from TRUE are 208/230 volts single phase.

Cabinet warranties are void if OEM power cord is tampered with. TRUE will not warranty any units that are connected to an extension cord.

INSTALLATION / OPERATION INSTRUCTIONS

**DEFROST TIME CLOCK OPERATION
(GRASSLIN TIMER)**

RECOMMENDED DEFROST SETTINGS:

TRUE Manufacturing has factory set your defrost time clock to a recommended time and duration defrost scenario. All units will require routine defrosts. Your TRUE equipment has been designed for three defrost periods (6:00 a.m., 2:00 p.m. and 10:00 p.m.). If you decide to deviate from these defrost time settings please follow the procedures for adjustment below.

NOTE

Defrost timer will need to be set at current time of day before plugging unit into power supply.

REQUIRED TOOLS:

- Phillips Screwdriver
- 1/4" Nut Driver or Socket

Locating The Defrost Timer:

Defrost timer is located in the lower right corner behind the louvered grill (inside galvanized electrical box).

Take off louvered grill assembly by removing four (4) corner screws.

Setting the timer:

(UNPLUG UNIT FROM POWER SUPPLY!)

DO NOT SET THE TIME BY ROTATING THE "OUTER" DIAL.

Turn the minute hand clockwise until the time of day on the outer dial is aligned with the triangle marker on the inner dial (two o'clock position).

Adjusting The Defrost Timer:

(time initiated, time or temperature terminated)

Your TRUE equipment contains a defrost system that is temperature terminated, however the time clock has been designed with a time termination back-up so that the defrost period will not exceed thirty minutes. While TRUE requires a minimum 3 defrost periods not to exceed 60 minutes the procedure on this page should be followed to customize your specific needs.

NOTICE

If timer is not set for a minimum of 3 defrost per day for 60 minutes each, the coil may develop excessive frost. This may lead to system failure and product loss, which is not covered under warranty.

The following procedure may be followed to customize your needs.

High usage, high temperature, and high humidity may require 4 defrost settings per day.

WARNING

Always follow the manufacturer's recommended settings when programming the amount and duration of the defrost cycles.

STEP 1

The white tabs located on the outmost area of the time clock have been factory set for (6:00 a.m., 2:00 p.m., and 10:00 p.m.). Each tab represents 15 minutes of defrost time. Notice that at each defrost time four white tabs are set for 15 minutes each for a total of 60 minutes of defrost.

STEP 2

In order to program the time to begin the defrost cycle, flip the white tabs out to set the defrost time. To eliminate a defrost time flip the white tabs back toward the center of the Defrost Timer.

STEP 3

TRUE recommends a 60 minute defrost cycle three times per day.



Defrost Timer Box Image 1

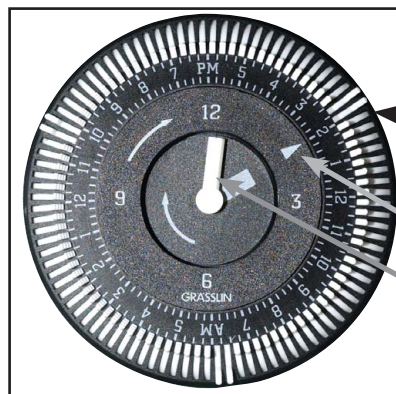

Defrost Timer Image 2

Outer most dial. White tabs represent 15 minutes of defrost time.

Time of day.

Inner most dial.

INSTALLATION / OPERATION INSTRUCTIONS

TEMPERATURE CONTROL ADJUSTMENT FOR HIGH ALTITUDE ONLY!

TERMS:

- **Cut-out** - Temperature sensed by the controller that shuts the compressor off.
- **Cut-in** - Temperature sensed by the controller that turns the compressor on.

TOOLS REQUIRED:

- Phillips head screwdriver
- 5/64" or 2 mm Allen Key
- T-7 Torx Key

STEP 1

Unplug or disconnect power to the cabinet.

STEP 2

Remove the screws that secure the temperature control to the inset box lower left side of the cabinet (when facing the front of the cabinet).

STEP 3

Pull out gently from cabinet.

NOTE

Mechanical temperature controllers are affected when functioning at high altitude. The Cut-in and cut-out temperatures will be colder than when the controller functions closer to sea level.

STEP 4

For high elevation installations, it may be necessary to "warm-up" the set points. To make the adjustment, insert the appropriate tool in each adjustment screw and turn 1/4 of a revolution clockwise (to the right). This procedure will adjust both the cut-in and cut-out about 2°F warmer.

STEP 5

Make sure to reconnect the pink wire to the proper spade terminal when reinstalling.

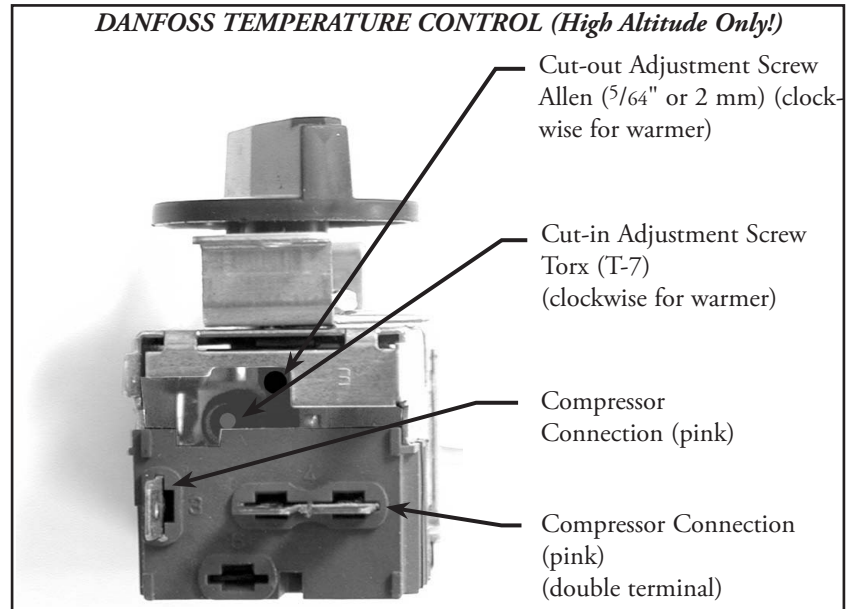

INSTALLATION / OPERATION INSTRUCTIONS

CONDUCTORS AND CIRCUITS

Wire Gauge for 2% Voltage Drop in Supply Circuits.

115 Volt Amps	Distance In Feet To Center of Load											
	20	30	40	50	60	70	80	90	100	120	140	160
2	14	14	14	14	14	14	14	14	14	14	14	14
3	14	14	14	14	14	14	14	14	14	14	14	12
4	14	14	14	14	14	14	14	14	14	12	12	12
5	14	14	14	14	14	14	14	12	12	12	10	10
6	14	14	14	14	14	14	12	12	12	10	10	10
7	14	14	14	14	14	12	12	12	10	10	10	8
8	14	14	14	14	12	12	12	10	10	10	8	8
9	14	14	14	12	12	12	10	10	10	8	8	8
10	14	14	14	12	12	10	10	10	10	8	8	8
12	14	14	12	12	10	10	10	8	8	8	8	6
14	14	14	12	10	10	10	8	8	8	6	6	6
16	14	12	12	10	10	8	8	8	8	6	6	6
18	14	12	10	10	8	8	8	8	8	8	8	5
20	14	12	10	10	8	8	8	6	6	6	5	5
25	12	10	10	8	8	6	6	6	6	5	4	4
30	12	10	8	8	6	6	6	6	5	4	4	3
35	10	10	8	6	6	6	5	5	4	4	3	2
40	10	8	8	6	6	5	5	4	4	3	2	2
45	10	8	6	6	6	5	4	4	3	3	2	1
50	10	8	6	6	5	4	4	3	3	2	1	1

Wire Gauge for 2% Voltage Drop in Supply Circuits.

230 Volt Amps	Distance In Feet To Center of Load											
	20	30	40	50	60	70	80	90	100	120	140	160
5	14	14	14	14	14	14	14	14	14	14	14	14
6	14	14	14	14	14	14	14	14	14	14	14	12
7	14	14	14	14	14	14	14	14	14	14	12	12
8	14	14	14	14	14	14	14	14	14	12	12	12
9	14	14	14	14	14	14	14	14	12	12	12	10
10	14	14	14	14	14	14	14	12	12	12	10	10
12	14	14	14	14	14	14	12	12	12	10	10	10
14	14	14	14	14	14	12	12	12	10	10	10	8
16	14	14	14	14	12	12	12	10	10	10	8	8
18	14	14	14	12	12	12	10	10	10	8	8	8
20	14	14	14	12	10	10	10	10	10	8	8	8
25	14	14	12	12	10	10	10	10	8	8	6	6
30	14	12	12	10	10	10	8	8	8	6	6	6
35	14	12	10	10	10	8	8	8	8	6	6	5
40	14	12	10	10	8	8	8	6	6	6	5	5
50	12	10	10	8	6	6	6	6	6	5	4	4
60	12	10	8	6	6	6	6	6	5	4	4	3
70	10	10	8	6	6	6	5	5	4	4	2	2
80	10	8	8	6	6	5	5	4	4	3	2	2
90	10	8	6	6	5	5	4	4	3	3	1	1
100	10	8	6	6	5	4	4	3	3	2	1	1

INSTALLATION / OPERATION INSTRUCTIONS

ELECTRICAL INSTRUCTIONS

- A.** Before your new unit is connected to a power supply, check the incoming voltage with a voltmeter. If anything less than 100% of the rated voltage for operation is noted, correct immediately.
- B.** All units are equipped with a service cord, and must be powered at proper operating voltage at all times. Refer to cabinet data plate for this voltage.

TRUE requires that a sole use circuit be dedicated for the unit. Failure to do so voids warranty.

WARNING

Compressor warranties are void if compressor burns out due to low voltage.

WARNING

Power supply cord ground should not be removed!

NOTE

To reference wiring diagram - Remove front louvered grill, wiring diagram is positioned on the inside cabinet wall.

Curved Glass Deli Cases

Deli cases are equipped with a service receptacle (found on the upper left cabinet backside), **No electrical load greater that 4.0 amps should be connected to it.** If the electrical load is greater that 4.0 amps, it should be wired separately or a larger lead cord should be wired in place of the provided lead cord. Use a cord with a 20 amp male plug (NEMA-5-20P).

STARTUP

- A.** The compressor is ready to operate. Plug in the unit.
- B.** Check the temperature control setting in the upper left of the cabinet backside. The setting should be at #5 to maintain an approximate 38°F (3.3°C). Set defrost time clock to the correct time of day.

NOTE

Excessive tampering with the control is not recommended as this can lead to service difficulties. Should it ever become necessary to order a replacement temperature control, be sure it is ordered from a dealer or recommended parts stocking service company.

- C.** Verify that the cabinet lights are working. Deli cases are shipped with light switches in the “on” position. The toggle switch is located upper left corner at the rear.

NOTE

If the deli case is disconnected or shut off, wait five minutes before starting again.

RECOMMENDATION

Before loading product we recommend you run your TRUE unit empty for two to three days. This allows you to be sure electrical wiring and installation are correct and no shipping damage has occurred. Remember, our factory warranty does not cover product loss!

REPLACEMENT PARTS

TRUE maintains a record of the cabinet serial number for your unit. If at any time during the life of your display case, a part is needed, you may obtain this part by furnishing the model number and serial number to the company from whom you purchased the cabinet. Call Toll-Free: (800)-424-TRUE (Direct to Parts Department). (800)-325-6152 (U.S.A. & Canada only) or call: (636)-240-2400.

TRUE CABINET SERIAL NUMBER: **1-9123456**

Manufacturing Co. OF FALLON, MD 63366

MODEL: TMW DESIGN PRESSURES-PSIG HIGH SIDE 488 LOW SIDE 174

REFRIG UNIT: AJA74942XD CHARGE REFRIGERANT: R404A 45 OZ.

HP	VOLTAGE	HZ	PH	F.L. AMPS
1	115/208/230	60	1	11.5

U.S. PATENT NUMBERS:
 5,553,354/5,433,082/5,182,923
 5,182,924/5,079,424/5,985,488
 4,890,748/4,875,745/4,127,988
 0273,288/0371,107/0,984,547
 2,045,722/5,699,676

DO NOT CLEAN LABEL WITH SOLVENT DRL

ENERGY SAVING

LISTED COMMERCIAL REFRIGERATOR 2004

EAD

Serial Number

INSTALLATION / OPERATION INSTRUCTIONS

SEALING CABINET TO FLOOR

- Optional**
- A.** It may be necessary to seal the deli case to the floor for local sanitary codes or if the customer so desires. TRUE recommends either of the following methods.
 - B.** Using a vinyl cover base trim as produced by Armstrong, Johnson, or Kentile (available at floor covering suppliers) or
 - C.** Using mastics available at hardware stores.
 - D.** When applying the cove base trim, thoroughly clean both the cabinet and floor of dirt and grease. Apply a recommended contact cement to the cove base trim. After cove base trim has dried, fill in cracks and joints with a caulking material.
 - E.** When applying a mastic, draw an outline of the cabinet on the floor. Raise and block the front side of the cabinet. Apply a bead of mastic to the floor 1/2" inside the outline drawn. Lower the cabinet. Raise and block the rear side of the cabinet. Apply the bead of mastic, lower the cabinet.

SHELVING INSTALLATION / OPERATION

STAINLESS STEEL SHELF INSTALLATION

NOTE
Shelf installation requires temporary removal of rear slide doors.

Step 1

- A.** Lift each door up and out of track (do not disconnect elastic tubing). Stretch elastic surgical tubing and set doors on each side of unit.
- B.** Locate two shelf supports wrapped in micro foam and install teeth end into stainless pilasters located on interior walls. Adjust to desired height matching right and left pairs. (See Figure 1 & 2).

Step 2

- A.** Locate the stainless steel shelf and install with product stop towards the front of the cabinet. Side flaps should overlap shelf support, be sure to fit shelf support tip into front slot of shelf. (See Figure 3-5).
- B.** Plug shelf light into receptacle. (See Figure 4).



Figure 1



Figure 2

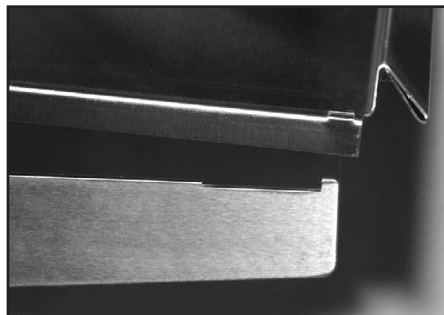

Figure 3

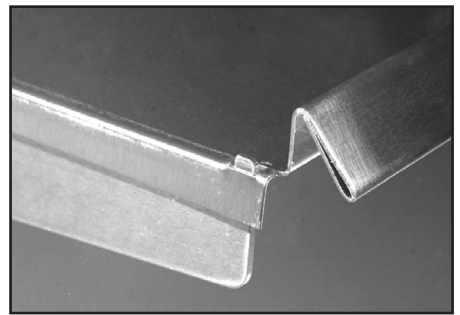

Figure 4



Figure 5



Figure 6

NOTE
Lights will not operate if they are not plugged in.

INSTALLATION / OPERATION INSTRUCTIONS

SHELVING INSTALLATION / OPERATION

INSTALLING BAKERY CASE SHELVES

Step 1

- A. Lift each door up and out of track (do not disconnect elastic tubing). Stretch elastic surgical tubing and set doors on each side of unit.
- B. Remove brackets, lights, shelves, etc. from cabinet interior.
- C. Locate shelf supports wrapped in micro foam and install teeth end into stainless pilasters located on interior walls. Adjust to desired height matching right and left pairs. See Figure 1 & 2.
- D. Locate three horizontal lights wrapped in micro foam and install (light side down). Electrical cords should be on the right to plug into side receptacle. Hang end hooks of light assembly on two shelf supports (left and right) slide assembly forward until it seats in front notch of shelf support. Then the stainless steel shelf can be installed on the shelf supports. See figures 3.

Wire Shelf Support Brackets:

- E. Install rear brackets by sliding end hooks over rear notch of shelf support. See figures 4.
- F. Locate wire shelves, install top shelf first. With the front lip (tray stop) up and towards cabinet front, place on top of front light assembly and snap wire shelf into (2) clips on top of rear bracket. See figures 5.
- G. Plug top light assembly into top receptacle of cabinet interior. See figures 5.
- H. Repeat procedures for remaining two wire shelves. See figures 6.
- I. Replace doors in track.

NOTE

Lights will not operate if they are not plugged in or plug cover is not plugged in.



Figure 1.



Figure 2.



Figure 3.



Figure 4.



Figure 5.



Figure 6.

MAINTENANCE, CARE & CLEANING

CLEANING THE CONDENSER COIL

TOOLS REQUIRED:

- Phillips Screwdriver
- 5/64" Stiff Bristle Brush
- Adjustable Wrench
- Vacuum Cleaner

STEP 1

Unplug or disconnect power to the cabinet.

STEP 2

Take off rear lower grill assembly by removing two (2) bottom screws. If necessary, loosen screws holding the top pivot pins. Swing grill up and remove frame hooks from pivot pins at top of louver.

STEP 3

Remove bolts anchoring compressor assembly to frame rails and carefully slide out (tube connections are flexible).

STEP 4

Clean off accumulated dirt from condensing coil with a stiff bristle brush.

STEP 5

Lift cardboard cover above fan at plastic plugs and carefully clean condenser coil and fan blades.

STEP 6

After brushing condenser coil vacuum dirt from coil, and interior floor.

STEP 7

Replace cardboard cover. Carefully slide compressor assembly back into position and replace bolts.

STEP 8

Reinstall louver assembly onto unit, tighten all screws.

STEP 9

Connect unit to power and check to see if condensing unit is running.

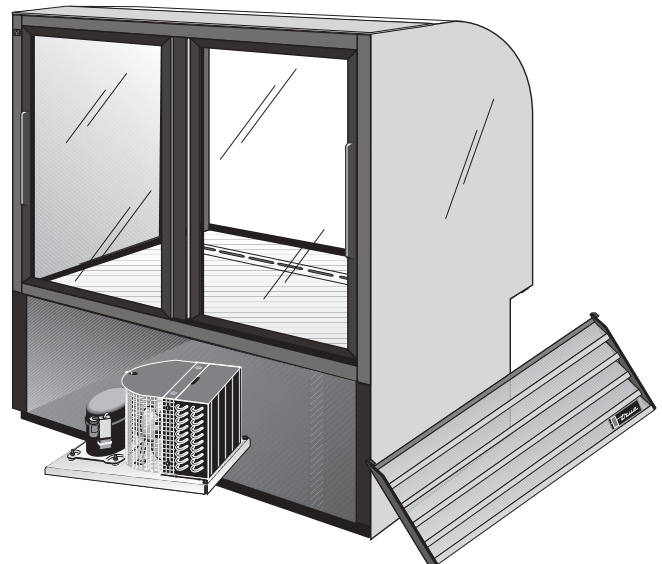
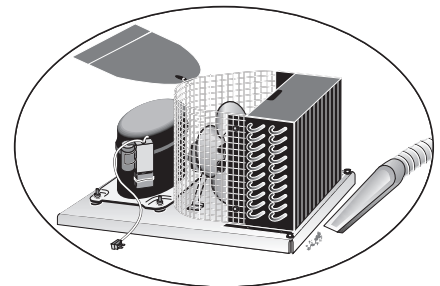
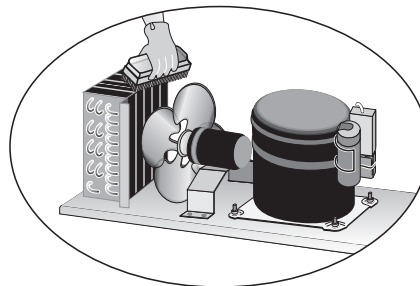

MAINTENANCE, CARE & CLEANING

IMPORTANT WARRANTY INFORMATION

Condensers accumulate dirt and require cleaning every 30 days. Dirty condensers result in compressor failure, product loss, and lost sales... which are not covered by warranty.

If you keep the Condenser clean you will minimize your service expense and lower your electrical costs. The Condenser requires scheduled cleaning every thirty days or as needed.

Air is pulled through the Condenser continuously, along with dust, lint, grease, etc.

A dirty Condenser can result in NON-WARRANTED part & Compressor Failures, Product Loss, and Lost Sales.

Proper cleaning involves removing dust from the Condenser. By using a soft brush, or vacuuming the Condenser with a shop vac, or using CO2, nitrogen, or pressurized air.

If you cannot remove the dirt adequately, please call your refrigeration service company.

The Condenser looks like a group of vertical fins. You need to be able to see through the condenser for the unit to function at maximum capacity. Do not place filter material in front of condensing coil. This material blocks air-flow to the coil similar to having a dirty coil.

THE CLEANING OF THE CONDENSER IS NOT COVERED BY THE WARRANTY!

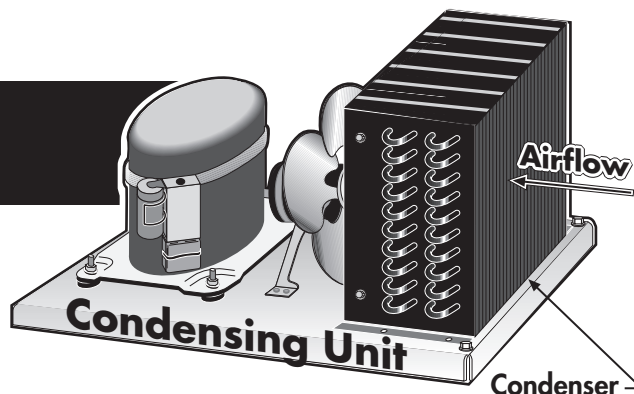

HOW TO CLEAN THE CONDENSER:

- 1. Disconnect the electrical power to the unit.**
- 2. Remove the louvered grill.**
- 3. Vacuum or brush the dirt, lint, or debris from the finned condenser coil.**
- 4. If you have a significant dirt build up you can blow out the condenser with compressed air.
(CAUTION MUST BE USED to avoid eye injury. Eye protection is recommended.)**
- 5. When finished be sure to replace the louvered grill. The grill protects the condenser.**
- 6. Reconnect the electrical power to the unit.**

If you have any questions, please call TRUE Manufacturing at 636-240-2400 or 800-325-6152 and ask for the Service Department. Service Department Availability Monday-Friday 7:30 a.m. to 5:30 p.m. and Saturday 8:00 a.m. to 12:00 p.m. CST.

MAINTENANCE, CARE & CLEANING

STAINLESS STEEL EQUIPMENT CARE AND CLEANING

CAUTION: Do not use any steel wool, abrasive or chlorine based products to clean stainless steel surfaces.

• Stainless Steel Opponents

There are three basic things which can break down your stainless steel's passivity layer and allow corrosion to rear its ugly head.

1. Scratches from wire brushes, scrapers, and steel pads are just a few examples of items that can be abrasive to stainless steel's surface.
2. Deposits left on your stainless steel can leave spots. You may have hard or soft water depending on what part of the country you live in. Hard water can leave spots. Hard water that is heated can leave deposits if left to sit too long. These deposits can cause the passive layer to break down and rust your stainless steel. All deposits left from food prep or service should be removed as soon as possible.
3. Chlorides are present in table salt, food, and water. Household and industrial cleaners are the worst type of chlorides to use.

8 steps that can help prevent rust on stainless steel:

1. Using the correct cleaning tools

Use non-abrasive tools when cleaning your stainless steel products. The stainless steel's passive layer will not be harmed by soft cloths and plastic scouring pads. Step 2 tells you how to find the polishing marks.

2. Cleaning along the polish lines

Polishing lines or "grain" are visible on some stainless steels. Always scrub parallel to visible lines on some stainless steels. Use a plastic scouring pad or soft cloth when you cannot see the grain.

3. Use alkaline, alkaline chlorinated or non-chloride containing cleaners

While many traditional cleaners are loaded with chlorides, the industry is providing an ever increasing choice of non-chloride cleaners. If you are not sure of your cleaner's chloride content contact your cleaner supplier. If they tell you that your present cleaner contains chlorides, ask if they have an alternative. Avoid cleaners containing quaternary salts as they can attack stainless steel, causing pitting and rusting.

4. Water Treatment

To reduce deposits, soften the hard water when possible. Installation of certain filters can remove corrosive and distasteful elements. Salts in a properly maintained water softener can be to your advantage. Contact a treatment specialist if you are not sure of the proper water treatment.

5. Maintaining the cleanliness of your food equipment

Use cleaners at recommended strength (alkaline, alkaline chlorinated or non-chloride). Avoid build-up of hard stains by cleaning frequently. When boiling water with your stainless steel equipment, the single most likely cause of damage is chlorides in the water. Heating any cleaners containing chlorides will have the same damaging effects.

6. Rinse

When using chlorinated cleaners you must rinse and wipe dry immediately. It is better to wipe standing cleaning agents and water as soon as possible. Allow the stainless steel equipment to air dry. Oxygen helps maintain the passivity film on stainless steel.

7. Hydrochloric acid (muriatic acid) should never be used on stainless steel

8. Regularly restore/passivate stainless steel

MAINTENANCE, CARE & CLEANING

STAINLESS STEEL EQUIPMENT CARE AND CLEANING

Recommended cleaners for certain situations / environments of stainless steel

- A) Soap, ammonia and detergent medallion applied with a cloth or sponge can be used for routine cleaning.
- B) Arcal 20, Lac-O-Nu Ecoshine applied provides barrier film for fingerprints and smears.
- C) Cameo, Talc, Zud First Impression is applied by rubbing in the direction of the polished lines for stubborn stains and discoloring.
- D) Easy-off and De-Grease It oven aid are excellent for removals on all finishes for grease-fatty acids, blood and burnt-on foods.
- E) Any good commercial detergent can be applied with a sponge or cloth to remove grease and oil.
- F) Benefit, Super Sheen, Sheila Shine are good for restoration / passivation.

NOTE
The use of stainless steel cleaners or other such solvents is not recommended on plastic parts. Warm soap and water will suffice.

LIGHT BULB REPLACEMENT

WARNING

Disconnect power to cabinet before replacing light bulbs.

Light Bulb Replacement:

- Be careful when removing the light bulb. Please be aware of your local ordinances in disposing old florescent bulbs. These

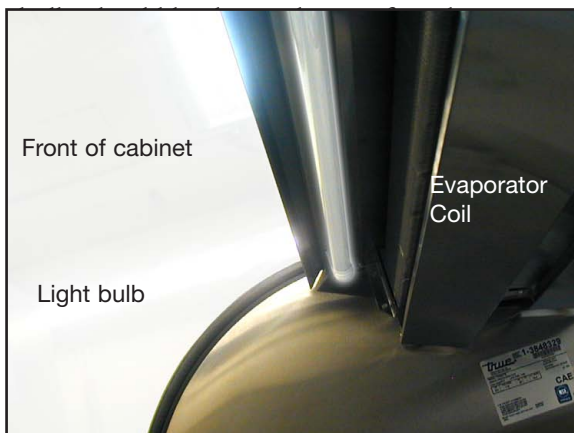

Inside the cabinet and toward the ceiling in front of the evaporator coil you will find a florescent bulb.



There are light bulbs located under the cabinet shelving.



WARRANTY INFORMATION (U.S.A. & CANADA ONLY!)

ONE YEAR PARTS & LABOR WARRANTY

TRUE warrants to the original purchaser of every new TRUE refrigerated unit, the cabinet and all parts thereof, to be free from defects in material or workmanship, under normal and proper use and maintenance service as specified by TRUE and upon proper installation and start-up in accordance with the instruction packet supplied with each TRUE unit. TRUE's obligation under this warranty is limited to a period of one (1) year from the date of original installation or 15 months after shipment date from TRUE, whichever occurs first.

Any part covered under this warranty that are determined by TRUE to have been defective within one (1) year of original installation or fifteen (15) months after shipment date from manufacturer, whichever occurs first, is limited to the repair or replacement, including labor charges, of defective parts or assemblies. The labor warranty shall include standard straight time labor charges only and reasonable travel time, as determined by TRUE.

ADDITIONAL FOUR YEAR COMPRESSOR WARRANTY

In addition to the one (1) year warranty stated above, TRUE warrants its hermetically and semi-hermetically sealed compressor to be free from defects in both material and workmanship under normal and proper use and maintenance service for a period of four (4) additional years from the date of original installation but not to exceed five (5) years and three (3) months after shipment from the manufacturer.

Compressors determined by TRUE to have been defective within this extended time period will, at TRUE's option, be either repaired or replaced with a compressor or compressor parts of similar design and capacity.

The four (4) year extended compressor warranty applies only to hermetically and semi-hermetically sealed parts of the compressor and does not apply to any other parts or components, including, but not limited to, cabinet, paint finish, temperature control, refrigerant, metering device, driers, motor starting equipment, fan assembly or any other electrical component, etcetera.

404A/134A COMPRESSOR WARRANTY

The four year compressor warranty detailed above will be voided if the following procedure is not carefully adhered to:

1. This system contains R404A or R134A refrigerant and polyol ester lubricant. The polyol ester lubricant has rapid moisture absorbing qualities. If long exposure to the ambient conditions occur, the lubricant must be removed and replaced with new. For oil amounts and specifications please call TRUE technical service department (800-325-6152). Failure to comply with recommended lubricant specification will void the compressor warranty.
2. Drier replacement is very important and must be changed when a system is opened for servicing. A drier using XH-7 desiccant or an exact replacement solid core drier must be used. The new drier must also be the same capacity as the drier being replaced.
3. Micron level vacuums must be achieved to insure low moisture levels in the system. 500 microns or lower must be obtained.

WARRANTY CLAIMS

All claims for labor or parts must be made directly through TRUE. All claims should include: model number of the unit, the serial number of the cabinet, proof of purchase, date of installation, and all pertinent information supporting the existence of the alleged defect.

In case of warranty compressor, the compressor model tag must be returned to TRUE along with above listed information. Any action or breach of these warranty provisions must be commenced within one (1) year after that cause of action has occurred.

WHAT IS NOT COVERED BY THIS WARRANTY

TRUE's sole obligation under this warranty is limited to either repair or replacement of parts, subject to the additional limitations below. This warranty neither assumes nor authorizes any person to assume obligations other than those expressly covered by this warranty.

NO CONSEQUENTIAL DAMAGES. TRUE IS NOT RESPONSIBLE FOR ECONOMIC LOSS; PROFIT LOSS; OR SPECIAL, INDIRECT, OR CONSEQUENTIAL DAMAGES, INCLUDING WITHOUT LIMITATION, LOSSES OR DAMAGES ARISING FROM FOOD OR PRODUCT SPOILAGE CLAIMS WHETHER OR NOT ON ACCOUNT OF REFRIGERATION FAILURE.

WARRANTY IS NOT TRANSFERABLE. This warranty is not assignable and applies only in favor of the original purchaser/user to whom delivered. ANY SUCH ASSIGNMENT OR TRANSFER SHALL VOID THE WARRANTIES HEREIN MADE AND SHALL VOID ALL WARRANTIES, EXPRESS OR IMPLIED, INCLUDING ANY WARRANTY OF MERCHANTABILITY OR FITNESS FOR A PARTICULAR PURPOSE.

IMPROPER USAGE. TRUE ASSUMES NO LIABILITY FOR PARTS OR LABOR COVERAGE FOR COMPONENT FAILURE OR OTHER DAMAGES RESULTING FROM IMPROPER USAGE OR INSTALLATION OR FAILURE TO CLEAN AND/OR MAINTAIN PRODUCT AS SET FORTH IN THE WARRANTY PACKET PROVIDED WITH THE UNIT.

ALTERATION, NEGLIGENCE, ABUSE, MISUSE, ACCIDENT, DAMAGE DURING TRANSIT OR INSTALLATION, FIRE, FLOOD, ACTS OF GOD. TRUE is not responsible for the repair or replacement of any parts that TRUE determines have been subjected after the date of manufacture to alteration, neglect, abuse, misuse, accident, damage during transit or installation, fire, flood, or act of God.

IMPROPER ELECTRICAL CONNECTIONS. TRUE IS NOT RESPONSIBLE FOR THE REPAIR OR REPLACEMENT OF FAILED OR DAMAGED COMPONENTS RESULTING FROM ELECTRICAL POWER FAILURE, THE USE OF EXTENSION CORDS, LOW VOLTAGE, OR VOLTAGE DROPS TO THE UNIT.

NO IMPLIED WARRANTY OF MERCHANTABILITY OR FITNESS FOR A PARTICULAR PURPOSE: THERE ARE NO OTHER WARRANTIES, EXPRESSED, IMPLIED OR STATUTORY, EXCEPT THE ONE (1) YEAR PARTS & LABOR WARRANTY AND THE ADDITIONAL FOUR (4) YEAR COMPRESSOR WARRANTY AS DESCRIBED ABOVE. THESE WARRANTIES ARE EXCLUSIVE AND IN LIEU OF ALL OTHER WARRANTIES, INCLUDING IMPLIED WARRANTY AND MERCHANTABILITY OR FITNESS FOR A PARTICULAR PURPOSE. THERE ARE NO WARRANTIES WHICH EXTEND BEYOND THE DESCRIPTION ON THE FACE HEREOF.

OUTSIDE U.S.: This warranty does not apply to, and TRUE is not responsible for, any warranty claims made on products sold or used outside the United States.

REMOTE CONDENSERS: TRUE warrants the original purchaser of the remote cabinet one year parts and labor coverage for all cabinet parts thereof to be free from defects in material or workmanship, under normal and proper use and maintenance service, as specified by TRUE. This warranty is limited to the cabinet only. True assumes no liability for remote condensing units.