

Instructions for Use

Microwave

SU45 MCX

USA



Dear Customer:

Before going any further, we want to thank you for preferring our product. We are sure that this modern, functional and practical microwave oven, manufactured with top quality materials, will fully meet your expectations.

We ask you to read the instructions in this booklet very carefully as this will allow you to get the best results from using your microwave oven.

KEEP THE DOCUMENTATION OF THIS PRODUCT FOR FUTURE REFERENCE.

Always keep the instruction manual handy. If you lend the microwave oven to someone else give them the manual as well!

The Speed Oven **SU45 MCX** complies with Part 18 of the FCC rules.

The responsible vendor is:

SMEG USA INC,
150E 58TH STREET 7TH FLOOR
NEW YORK - NY 10155
TEL. +1 212 265 5378
FAX +1 212 265 5945

1	GROUNDING INSTRUCTIONS	2
2	IMPORTANT SAFETY INSTRUCTIONS	3
3	PRECAUTIONS TO AVOID POSSIBLE EXPOSURE TO EXCESSIVE MICROWAVE ENERGY	5
4	DISPOSAL INSTRUCTIONS - OUR ENVIRONMENT POLICY	7
5	SAFETY PRECAUTIONS	8
6	GET TO KNOW YOUR OVEN	11
7	BEFORE INSTALLATION	11
8	DESCRIPTION OF FRONT PANEL CONTROLS	12
9	USING THE OVEN.....	14
10	ACCESSORIES AVAILABLE	20
11	RECOMMENDED COOKING TABLES.....	21
12	CLEANING AND MAINTENANCE	33
13	EXTRAORDINARY MAINTENANCE	35
14	INSTALLING THE APPLIANCE	37

INSTRUCTIONS FOR THE USER: *these provide recommendations for use, a description of the controls and the correct procedures for cleaning and maintaining the appliance*



INSTRUCTIONS FOR THE INSTALLER: *these are intended for the qualified engineer who is to install, commission and test the appliance*



GROUNDING INSTRUCTIONS

1 *GROUNDING INSTRUCTIONS*

THIS APPLIANCE MUST BE GROUNDED. IN THE EVENT OF AN ELECTRICAL SHORT CIRCUIT, GROUNDING REDUCES THE RISK OF ELECTRIC SHOCK BY PROVIDING AN ESCAPE WIRE FOR THE ELECTRIC CURRENT. THIS APPLIANCE IS EQUIPPED WITH A CORD HAVING A GROUNDING WIRE WITH A GROUNDING PLUG. THE PLUG MUST BE PLUGGED INTO AN OUTLET THAT IS PROPERLY INSTALLED AND GROUNDED.

WARNING! IMPROPER USE OF THE GROUNDING CAN RESULT IN A RISK OF ELECTRICAL SHOCK.

CONSULT A QUALIFIED ELECTRICIAN OR SERVICEMAN IF THE GROUNDING INSTRUCTIONS ARE NOT COMPLETELY UNDERSTOOD, OR IF DOUBT EXISTS AS TO WHETHER THE APPLIANCE IS PROPERLY GROUNDED, AND DO NOT USE AN EXTENSION CORD. IF THE POWER SUPPLY CORD IS TOO SHORT, HAVE A QUALIFIED ELECTRICIAN OR SERVICEMEN INSTALL AN OUTLET NEAR THE APPLIANCE.

IMPORTANT SAFETY INSTRUCTIONS

2 IMPORTANT SAFETY INSTRUCTIONS

WHEN USING ELECTRICAL APPLIANCES BASIC SAFETY PRECAUTIONS SHOULD BE FOLLOWED, INCLUDING THE FOLLOWING:

WARNING! TO REDUCE THE RISK OF BURNS, ELECTRIC SHOCK, FIRE, INJURY TO PERSONS, OR EXPOSURE TO EXCESSIVE MICROWAVE ENERGY:

- READ ALL INSTRUCTIONS BEFORE USING THE APPLIANCE.
- READ AND FOLLOW THE SPECIFIC “PRECAUTIONS TO AVOID POSSIBLE EXPOSURE TO EXCESSIVE MICROWAVE ENERGY” FOUND ON THIS MANUAL.
- THIS APPLIANCE MUST BE GROUNDED. CONNECT ONLY TO PROPERLY GROUNDED OUTLET. SEE “GROUNDING INSTRUCTIONS” FOUND ON THIS MANUAL.
- INSTALL OR LOCATE THIS APPLIANCE ONLY IN ACCORDANCE WITH THE PROVIDED INSTALLATION INSTRUCTIONS.
- SOME PRODUCTS SUCH AS WHOLE EGGS AND SEALED CONTAINERS – FOR EXAMPLE, CLOSED GLASS JARS ARE ABLE TO EXPLODE AND SHOULD NOT BE HEATED IN THIS OVEN.
- USE THIS APPLIANCE ONLY FOR ITS INTENDED USE AS DESCRIBED IN THE MANUAL. DO NOT USE CORROSIVE CHEMICALS OR VAPORS IN THIS APPLIANCE. THIS TYPE OF OVEN IS SPECIFICALLY DESIGNED TO HEAT, COOK, OR DRY FOOD. IT IS NOT DESIGNED FOR INDUSTRIAL OR LABORATORY USE.
- AS WITH ANY APPLIANCE, CLOSE SUPERVISION IS NECESSARY WHEN USED BY CHILDREN.
- DO NOT OPERATE THIS APPLIANCE IF IT IS HAS A DAMAGED CORD OR PLUG, IF IT IS NOT WORKING PROPERLY, OR IF IT HAS BEEN DAMAGED OR DROPPED.
- ***THIS APPLIANCE SHOULD BE SERVICED ONLY BY QUALIFIED SERVICE PERSONNEL. CONTACT NEAREST AUTHORIZED SERVICE FACILITY FOR EXAMINATION, REPAIR, OR ADJUSTMENT.***
- DO NOT COVER OR BLOCK ANY OPENINGS ON THE APPLIANCES.
- DO NOT STORE THIS APPLIANCE OUTDOORS. DO NOT USE THIS PRODUCT NEAR WATER – FOR EXAMPLE, NEAR A KITCHEN SINK, IN A WET BASEMENT, NEAR A SWIMMING POOL, OR SIMILAR LOCATIONS.
- DO NOT IMMERSE CORD OR PLUG IN WATER.
- KEEP CORD AWAY FROM HEATED SURFACES.

IMPORTANT SAFETY INSTRUCTIONS

USA

- DO NOT LET CORD HANG OVER EDGE OF TABLE OR COUNTER.
- WHEN CLEANING SURFACES OF DOOR AND OVEN THAT COMES TOGETHER ON CLOSING THE DOOR, USE ONLY MILD, NONABRASIVE SOAPS, OR DETERGENTS APPLIED WITH A SPONGE OR SOFT CLOTH.

TO REDUCE THE RISK OF FIRE IN THE OVEN CAVITY:

- DO NOT OVERCOOK FOOD. CAREFULLY ATTEND APPLIANCE WHEN PAPER, PLASTIC, OR OTHER COMBUSTIBLE MATERIALS ARE PLACED INSIDE THE OVEN TO FACILITATE COOKING.
- REMOVE WIRE TWIST-TIES FROM PAPER OR PLASTIC BAGS BEFORE PLACING BAG IN OVEN.
- IF MATERIALS INSIDE THE OVEN IGNITE, KEEP OVEN DOOR CLOSED, TURN OVEN OFF, AND DISCONNECT THE POWER CORD, OR SHUT OFF POWER AT THE FUSE OR CIRCUIT BREAKER PANEL.
- DO NOT USE THE CAVITY FOR STORAGE PURPOSES. DO NOT LEAVE PAPER PRODUCTS, COOKING UTENSILS, OR FOOD IN THE CAVITY WHEN NOT IN USE.
- LIQUIDS SUCH AS WATER, COFFEE, OR TEA ARE ABLE TO BE OVERHEATED BEYOND THE BOILING POINT WITHOUT APPEARING TO BE BOILING.
- VISIBLE BUBBLING OR BOILING WHEN THE CONTAINER IS REMOVED FROM THE MICROWAVE OVEN IS NOT ALWAYS PRESENT. THIS COULD RESULT IN VERY HOT LIQUIDS SUDDENLY BOILING OVER WHEN THE CONTAINER IS DISTURBED OR A UTENSIL INTO THE LIQUID.

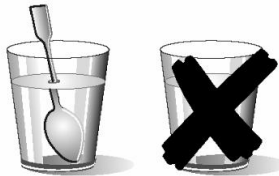

TO AVOID THAT TYPE OF SITUATION WHEN HEATING LIQUIDS, PUT A TEASPOON OR GLASS ROD INSIDE THE CONTAINER.

SAVE THESE INSTRUCTIONS!

PRECAUTIONS TO AVOID POSSIBLE EXPOSURE TO EXCESSIVE MICROWAVE ENERGY

3 *PRECAUTIONS TO AVOID POSSIBLE EXPOSURE TO EXCESSIVE MICROWAVE ENERGY*

DO NOT ATTEMPT TO OPERATE THIS OVEN WITH THE DOOR OPEN SINCE OPEN – DOOR OPERATION CAN RESULT IN HARMFUL EXPOSURE TO MICROWAVE ENERGY. IT IS IMPORTANT NOT TO DEFEAT OR TAMPER WITH THE SAFETY INTERLOCKS.

DO NOT PLACE ANY OBJECT BETWEEN THE OVEN FRONT FACE AND THE DOOR OR ALLOW SOIL OR CLEANER RESIDUE TO ACCUMULATE ON SEALING SURFACES.

DO NOT OPERATE THE OVEN IF IT IS DAMAGED. IT IS PARTICULARLY IMPORTANT THAT THE OVEN DOOR CLOSE PROPERLY AND THAT THERE IS NO DAMAGE TO THE: DOOR (BENT), HINGES AND LATCHES (BROKEN OR LOOSENED), DOOR SEALS AND SEALING SURFACES.

THE OVEN SHOULD NOT BE ADJUSTED OR REPAIRED BY ANYONE EXCEPT PROPERLY QUALIFIED SERVICE PERSONNEL.

PACEMAKERS:

MOST PACEMAKERS ARE SHIELDED FROM INTERFERENCE FROM ELECTRONIC PRODUCTS, INCLUDING MICROWAVES. HOWEVER, PATIENTS WITH PACEMAKERS MAY WISH TO CONSULT THEIR PHYSICIANS IF THEY HAVE CONCERNS.

Safety Precautions

USA



INSTALLATION MUST BE CARRIED OUT BY QUALIFIED STAFF IN COMPLIANCE WITH THE RELEVANT REGULATIONS. THIS APPLIANCE IS INTENDED FOR HOUSEHOLD USE AND COMPLIES WITH THE EEC DIRECTIVES CURRENTLY IN FORCE. THE APPLIANCE IS BUILT TO PROVIDE THE FOLLOWING FUNCTION: COOKING AND HEATING FOODS; ALL OTHER USES ARE TO BE CONSIDERED IMPROPER.

THE MANUFACTURER DECLINES ALL LIABILITY FOR USES OTHER THAN THOSE STATED ABOVE.

KEEP THE DOCUMENTATION OF THIS PRODUCT FOR FUTURE REFERENCE.

ALWAYS KEEP THE INSTRUCTION MANUAL HANDY. IF YOU LEND THE MICROWAVE OVEN TO SOMEONE ELSE GIVE THEM THE MANUAL AS WELL!



THIS APPLIANCE IS DESIGNED FOR COOKING FOOD AND IT SHALL NOT BE USED AS A SPACE HEATER.



DO NOT SPRAY AEROSOLS IN THE VICINITY OF THIS APPLIANCE WHILE IT IS IN OPERATION.



NEVER LEAVE PACKAGING RESIDUES UNATTENDED IN THE HOME. SEPARATE THE VARIOUS PACKAGING MATERIALS BY TYPE AND CONSIGN THEM TO THE NEAREST SEPARATE DISPOSAL CENTRE.



THIS APPLIANCE IS TAGGED UNDER EUROPEAN DIRECTIVE 2002/96/EC ON WASTE ELECTRICAL AND ELECTRONIC EQUIPMENT (WEEE).

THIS DIRECTIVE CONTAINS THE REGULATIONS GOVERNING THE COLLECTION AND RECYCLING OF DECOMMISSIONED APPLIANCES THROUGHOUT THE EUROPEAN UNION.



REPLACED APPLIANCES MUST BE TAKEN TO A SPECIAL GARBAGE COLLECTION CENTRE.



NEVER OBSTRUCT THE OPENINGS AND SLITS PROVIDED FOR VENTILATION AND HEAT DISPERSAL.



THE I.D. PLATE WITH TECHNICAL DATA, REGISTRATION NUMBER AND BRAND NAME IS POSITIONED VISIBLY ON THE OVEN DOOR FRAME.

THE PLATE MUST NOT BE REMOVED.



NEVER USE METAL SCOURING PADS OR SHARP SCRAPERS WHICH WILL DAMAGE THE SURFACE.

USE ORDINARY NON-ABRASIVE PRODUCTS WITH THE AID OF WOODEN OR PLASTIC UTENSILS IF NECESSARY. RINSE THOROUGHLY AND DRY WITH A SOFT CLOTH OR CHAMOIS LEATHER.

DO NOT ALLOW SPILLS OF FOODS WITH HIGH SUGAR CONTENT (E.G. JAM) TO DRY INSIDE THE OVEN. IF THEY DRY FOR TOO LONG, THEY MIGHT DAMAGE THE ENAMEL COATING OF THE INSIDE OF THE OVEN.





4 **DISPOSAL INSTRUCTIONS - OUR ENVIRONMENT POLICY**

Our products are only packaged using non-pollutant, environment-friendly, recyclable materials. We urge you to cooperate by disposing of the packaging properly. Contact your local dealer or the competent local organisations for the addresses of collection, recycling and disposal facilities.

Never leave all or part of the packaging lying around. Packaging parts, and especially plastic bags, may represent a suffocation hazard for children.

Your old appliance must also be disposed of properly.

Important: deliver the appliance to your local organisation authorised to collect scrapped appliances. Proper disposal allows the intelligent recovery of valuable materials.

Before scrapping your appliance it is important to remove doors and leave shelves in position as for use, to ensure that children cannot accidentally become trapped inside the oven during play. Also, cut the power supply lead and remove it and the plug.

5 SAFETY PRECAUTIONS



REFER TO THE INSTALLATION INSTRUCTIONS FOR THE SAFETY REGULATIONS FOR ELECTRIC OR GAS APPLIANCES AND VENTILATION FUNCTIONS.

IN YOUR INTEREST AND TO ENSURE YOUR SAFETY, BY LAW ALL ELECTRIC APPLIANCES MUST ONLY BE INSTALLED AND SERVICED BY QUALIFIED STAFF, IN ACCORDANCE WITH THE RELEVANT REGULATIONS.

OUR APPROVED INSTALLATION ENGINEERS GUARANTEE YOU A JOB WELL DONE.

GAS OR ELECTRIC APPLIANCES MUST ALWAYS BE DISCONNECTED BY SUITABLY SKILLED PEOPLE.



THE PLUG TO BE CONNECTED TO THE POWER SUPPLY LEAD AND THE RELATIVE SOCKET MUST BE OF THE SAME TYPE AND COMPLY WITH THE RELEVANT REGULATIONS.

THE POWER SUPPLY SOCKET MUST BE ACCESSIBLE EVEN AFTER THE APPLIANCE HAS BEEN BUILT-IN.

NEVER DISCONNECT THE PLUG BY PULLING ON THE POWER SUPPLY LEAD



IMMEDIATELY AFTER INSTALLATION, CARRY OUT A QUICK TEST ON THE OVEN FOLLOWING THE INSTRUCTIONS PROVIDED LATER IN THIS MANUAL. DURING THE TESTS PUT A GLASS OF WATER INSIDE THE OVEN AS IT WILL ABSORB THE MICROWAVES AND THE OVEN WILL NOT BE DAMAGED. IF THE APPLIANCE FAILS TO OPERATE, DISCONNECT IT FROM THE ELECTRICAL MAINS AND CONTACT YOUR NEAREST SERVICE CENTRE. NEVER ATTEMPT TO REPAIR THE APPLIANCE.



WARNING! NEVER LEAVE THE OVEN UNWATCHED, ESPECIALLY WHEN USING PAPER, PLASTIC OR OTHER COMBUSTIBLE MATERIALS. THESE MATERIALS CAN CHAR AND MAY FIRE. FIRE RISK!

WARNING! IF YOU SEE SMOKE OR FIRE, KEEP THE DOOR CLOSED IN ORDER TO SMOTHER THE FLAMES. SWITCH OFF THE OVEN AND TAKE THE PLUG OUT OF THE SOCKET OR CUT OFF THE OVEN POWER SUPPLY.

WARNING! DO NOT HEAT PURE ALCOHOL

.-+ OR ALCOHOLIC DRINKS IN THE MICROWAVE. FIRE RISK!

WARNING! DO NOT HEAT LIQUIDS OR OTHER FOODS IN CLOSED CONTAINERS SINCE THESE MAY EXPLODE READILY.

WARNING! NEVER PUT INFLAMMABLE OBJECTS IN THE OVEN: THEY COULD BE ACCIDENTALLY CATCH LIGHT AND CAUSE FIRES.



THIS APPLIANCE IS NOT INTENDED FOR USE BY PERSONS (INCLUDING CHILDREN) WITH REDUCED PHYSICAL, SENSORY OR MENTAL CAPABILITIES, OR LACK OF EXPERIENCE AND KNOWLEDGE, UNLESS THEY HAVE BEEN GIVEN SUPERVISION OR INSTRUCTION CONCERNING USE OF THE APPLIANCE BY A PERSON RESPONSIBLE FOR THEIR SAFETY. CHILDREN SHOULD BE SUPERVISED TO ENSURE THAT THEY DO NOT PLAY WITH THE APPLIANCE.



WARNING: ACCESSIBLE PARTS MAY BECOME HOT DURING USE. YOUNG CHILDREN SHOULD BE KEPT AWAY.

Safety Precautions

WARNING: DURING USE THE APPLIANCE BECOMES HOT. CARE SHOULD BE TAKEN TO AVOID TOUCHING HEATING ELEMENTS INSIDE THE OVEN. TO AVOID BURNS AND SCALDS CHILDREN SHOULD BE KEPT AWAY.

WARNING! THE OVEN CANNOT BE USED IF:

- THE DOOR IS NOT CLOSED CORRECTLY;
- THE DOOR HINGES ARE DAMAGED;
- THE SURFACES OF THE CONTACT BETWEEN THE DOOR AND THE OVEN FRONT ARE DAMAGED;
- THE DOOR WINDOW GLASS IS DAMAGED;
- THERE IS FREQUENT ELECTRICAL ARCING INSIDE THE OVEN EVEN THOUGH THERE IS NO METAL OBJECT INSIDE.

THE OVEN **CAN ONLY BE USED AGAIN** AFTER IT HAS BEEN REPAIRED BY A TECHNICAL ASSISTANCE SERVICE TECHNICIAN.



BEWARE!

NEVER HEAT BABY FOODS OR DRINKS IN BOTTLES OR JARS WITH THE TEATS OR LIDS ON THEM. AFTER HEATING THE FOOD MIX OR SHAKE WELL SO THAT THE HEAT IS SPREAD EVENLY. CHECK THE FOOD TEMPERATURE BEFORE FEEDING THIS TO THE CHILD. DANGER OF BURNING!

TO AVOID FOOD OVERHEATING OR BURNING IT IS VERY IMPORTANT NOT TO SELECT LONG TIME PERIODS OR POWER LEVELS THAT ARE TOO HIGH WHEN HEATING SMALL QUANTITIES OF FOOD. FOR EXAMPLE, A BREAD ROLL CAN BURN AFTER 3 MINUTES IF THE POWER SELECTED IS TOO HIGH. FOR TOASTING, USE JUST THE GRILLING FUNCTION AND WATCH THE OVEN ALL THE TIME. IF YOU USE A COMBINED FUNCTION TO TOAST BREAD IT WILL CATCH FIRE IN A VERY SHORT TIME.



THIS OVEN IS EXCLUSIVELY FOR DOMESTIC USE!

USE THE OVEN ONLY FOR PREPARING MEALS.

AVOID DAMAGING THE OVEN OR OTHER DANGEROUS SITUATIONS BY FOLLOWING THESE INSTRUCTIONS:

- Do not switch on the oven **without** the turntable support, the turntable ring and the respective plate being in place.
- **Never switch on the microwave when it is empty.** If there is no food inside there may be an electrical overcharge and the oven could be damaged. **RISK OF DAMAGE!**
- Do not cover or obstruct the **ventilation openings.**
- Use only **dishes suitable** for microwaves. Before using dishes and containers in the microwave, check that these are suitable (see the section on types of dishes).
- **Never remove the mica cover on the ceiling of the oven interior!** This cover stops fat and pieces of food damaging the microwave generator.
- Do not keep any **flammable object** inside the oven as it may burn if the oven is switched on.
- Do not use the oven as a **pantry.**
- **Eggs with their shells** and **whole boiled eggs** must not be heated in microwave ovens because they may explode.

- Do not use the oven for **frying** as it is impossible to control the temperature of oil heated by microwaves.
- **To avoid being burnt**, always use oven gloves for handling dishes and containers and touching the oven.
- **Do not lean or sit on the open oven door.** This may damage the oven, especially in the hinge zone. The door can bear a maximum weight of 8 kg.
- The turntable and the grills can bear a **maximum load of 8 kg**. To avoid damaging the oven, do not exceed this load.

CLEANING:

- **Warning!** Your microwave oven must be cleaned regularly. All food remains must be removed (see section on Oven Cleaning). If the microwave oven is not kept clean its surface may deteriorate and **this may shorten the oven's working life and could even result in a dangerous situation.**
- The door contact surfaces (the front of the cavity and the inside part of the doors) must be kept very clean in order to ensure the oven functions correctly.
- **DO NOT USE HARSH ABRASIVE CLEANERS OR SHARP METAL SCRAPERS TO CLEAN THE OVEN DOOR GLASS SINCE THEY CAN SCRATCH THE SURFACE, WHICH MAY RESULT IN SHATTERING OF THE GLASS.**
- Please follow the instructions regarding cleaning in the section "Oven Cleaning and Maintenance".

REPAIRS:

- **Warning – Microwaves! The outer protection of the oven must not be removed.** It is dangerous for anyone not authorised by the manufacturer to carry out any kind of repair or maintenance work.
- If the power cable is damaged it should be substituted by the manufacturer, authorised agents or technicians qualified for this task in order to avoid dangerous situations. Furthermore, special tools are required for this task.
- Repair and maintenance work, especially of current carrying parts, can only be carried out by technicians authorised by the manufacturer.



The manufacturer declines all responsibility for injury or damage caused by failure to comply with the above regulations or deriving from tampering with even just one part of the appliance and the use of non-original spare parts.



6 GET TO KNOW YOUR OVEN

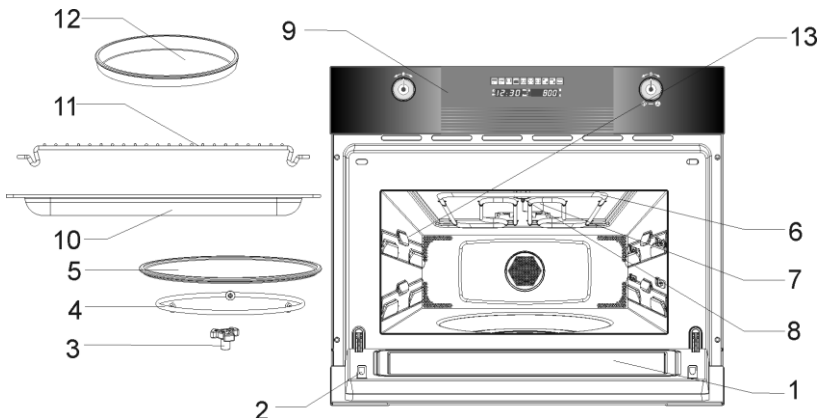

- 1. – Door window glass
- 2. – Catches
- 3. – Turntable support
- 4. – Turntable ring
- 5. – Turntable plate
- 6. – Grill Element
- 7. – Mica cover

- 8. – Lamp
- 9. – Control panel
- 10. – Glass tray
- 11. – Shelf (**DO NOT USE WITH MICROWAVES**)
- 12. – Browning plate
- 13. – Lateral supports

7 BEFORE INSTALLATION



Never leave packaging residues unattended in the home. Separate waste packaging materials by type and consign them to the nearest separate disposal centre.



The inside of the appliance should be cleaned to remove all manufacturing residues. For further information about cleaning, see point "10. CLEANING AND MAINTENANCE".



8 DESCRIPTION OF FRONT PANEL CONTROLS

All the appliance's control and monitoring devices are placed together on the front panel. The table below provides the key to the symbols used.

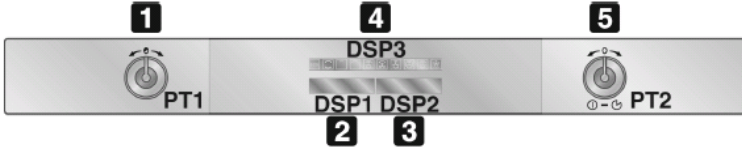

1
PT1

FUNCTION'S PARAMETERS KNOB

This knob allows you to set the time, select the cooking temperature and duration and program the cooking start and end times. From now on, for convenience it will be referred to as PT1. For instructions on how to use it correctly, see the next chapters.

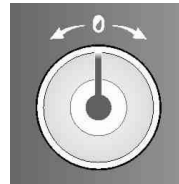

2
DSP1

CURRENT TIME / DURATION DISPLAY

This display shows the current time or the cooking duration. Also visible are the function cut-out light (see point "7.6.3 Child safety lock-out function")

From now on, for convenience it will be referred to as DSP1.

3
DSP2

TEMPERATURE / MICROWAVES POWER / WEIGHT DISPLAY

This display shows the Parameters set for the function required, or the Parameters set by the user.

From now on, for convenience it will be referred to as DSP2.

4
DSP3

FUNCTION DISPLAY

This display shows (illuminated) all the cooking functions available for selection. For instructions on how to select a cooking function, see point "7.2 Operating settings".

From now on, for convenience it will be referred to as DSP3.



5

PT2

FUNCTION-SWITCH ON KNOB

This knob allows access to the oven's three operating settings, and is also used to select a cooking function (see point "9.2 Operating settings").

From now on, for convenience it will be referred to as PT2.

The table below provides a short description of the functions available.



MICROWAVES



ROUND HEATING ELEMENT + FAN



MICROWAVES + GRILL ELEMENT



GRILL ELEMENT + ROUND HEATING ELEMENT + FAN



MICROWAVES + ROUND HEATING ELEMENT + FAN



DEFROST BY TIME



GRILL ELEMENT



DEFROST BY WEIGHT



GRILL ELEMENT + FAN



PIZZA FUNCTION



9 USING THE OVEN

9.1 Precautions and General Advice



When the oven and grill are used for the first time, they should be heated to the maximum temperature for long enough to burn off any oily residues left by the manufacturing process, which might contaminate foods with unpleasant smells.



Oven accessories which may come into contact with foods are made from materials compliant with directive 89/109/EEC of 21/12/88 and national relevant regulations.



To prevent excessive amounts of condensation from forming on the internal glass, food should not be left inside the oven for too long after cooking.

9.2 Operating settings

This product is programmed to provide 3 operating settings, which can be modified by pressing PT2.

Standby setting: activated as soon as the current time has been confirmed, with DSP1 on and showing the current time.

ON setting: from the standby setting, press PT2 once. All the displays and knobs light up.

OFF setting: from the ON setting, press PT2 once.

Only the symbol  on DSP1 remains on.

The heating system is not activated immediately in any of these functions, in order to improve operator safety.

9.3 First Use

At first use, or after a power failure, the oven's left hand-display, DSP1, will show a flashing  symbol. To start any cooking operation, the current time must be set.

9.3.1 Setting the current time

To set the current time, turn PT1 to the right and left to increase or decrease the hours. Press it once to move on to setting the minutes. Turn it the right and left to increase or decrease the minutes and press it to set the current time. The symbol  will appear on the display, which will stop flashing.

9.3.2 Setting the current time

It might become necessary to change the current time, for example at the switch from summer to winter time. To do this, starting from the standby setting (see point "7.2 Operating settings") keep PT1 pressed for a few seconds until the figures on DSP1 flash. Now repeat the operations described in point "7.3.1 Setting the current time".



Selecting the function

In the ON state only, a cooking function can be selected by simply turning PT2 to the right or left. The function selected will change colour to orange on DSP3. The preset cooking time will be displayed on DSP1 and the preset parameters (temperature, microwaves power, weight) are displayed in alternation on DSP2.

9.3.3 **Microwaves function**

After selecting this function **press PT1 to set the parameters and the duration light  starts to blink**. Turn PT1 to the right or left to change the preset cooking duration.

Press PT1 to validate and the microwaves power light **W** starts to blink.

Turn PT1 to the right or left to change the preset microwaves power.

Press PT2 to immediately start the cooking process or otherwise press PT1 to set a different time for the cooking process start (please refer to point "9.3.13 Delayed Start Time (Automatic cooking)").

9.3.4 **Microwaves+ Grill Element function**

After selecting this function **press PT1 to set the parameters and the duration light  starts to blink**. Turn PT1 to the right or left to change the preset cooking duration.

Press PT1 to validate and the microwaves power light **W** starts to blink.

Turn PT1 to the right or left to change the preset microwaves power.

Press PT2 to immediately start the cooking process or otherwise press PT1 to set a different time for the cooking process start (please refer to point "9.3.13 Delayed Start Time (Automatic cooking)").

9.3.5 **Microwaves+ Round Heating Element + Fan function**

After selecting this function **press PT1 to set the parameters and the duration light  starts to blink**. Turn PT1 to the right or left to change the preset cooking duration.

Press PT1 to validate and the microwaves power light **W** starts to blink.

Turn PT1 to the right or left to change the preset microwaves power.

Press PT1 to validate and the temperature light **T** starts to blink.

Turn PT1 to the right or left to change the preset temperature.

Press PT2 to immediately start the cooking process or otherwise press PT1 to set a different time for the cooking process start (please refer to point "9.3.13 Delayed Start Time (Automatic cooking)").

The temperature light **T** will blink until the cavity temperature has reached the set value.



Instructions for the User

USA

9.3.6 **Grill Element function**

After selecting this function **press PT1 to set the parameters and the duration light  starts to blink**. Turn PT1 to the right or left to change the preset cooking duration.

Press PT1 to validate.

Press PT2 to immediately start the cooking process or otherwise press PT1 to set a different time for the cooking process start (please refer to point “9.3.13 Delayed Start Time (Automatic cooking)”).

9.3.7 **Grill Element + Fan function**

After selecting this function **press PT1 to set the parameters and the duration light  starts to blink**. Turn PT1 to the right or left to change the preset cooking duration.

Press PT1 to validate.

Press PT2 to immediately start the cooking process or otherwise press PT1 to set a different time for the cooking process start (please refer to point “9.3.13 Delayed Start Time (Automatic cooking)”).

The temperature light  will blink until the cavity temperature has reached the set value.

9.3.8 **Round Heating Element + Fan function**

After selecting this function **press PT1 to set the parameters and the duration light  starts to blink**. Turn PT1 to the right or left to change the preset cooking duration.

Press PT1 to validate and the temperature light  starts to blink.

Turn PT1 to the right or left to change the preset temperature.

Press PT2 to immediately start the cooking process or otherwise press PT1 to set a different time for the cooking process start (please refer to point “9.3.13 Delayed Start Time (Automatic cooking)”).

The temperature light  will blink until the cavity temperature has reached the set value.

9.3.9 **Grill Element + Round Heating Element + Fan function**

After selecting this function **press PT1 to set the parameters and the duration light  starts to blink**. Turn PT1 to the right or left to change the preset cooking duration.

Press PT1 to validate and the temperature light  starts to blink.

Turn PT1 to the right or left to change the preset temperature.

Press PT2 to immediately start the cooking process or otherwise press PT1 to set a different time for the cooking process start (please refer to point “9.3.13 Delayed Start Time (Automatic cooking)”).

The temperature light  will blink until the cavity temperature has reached the set value.



9.3.10 Defrost by Time function

After selecting this function **press PT1 to set the parameters and the duration light  starts to blink.** Turn PT1 to the right or left to change the preset defrosting duration.

Press PT2 to start the defrosting process.

The microwaves power will be automatically varied to achieve the best thawing results.

9.3.11 Defrost by Weight function

After selecting this function **press PT1 to set the parameters and the duration light  starts to blink.** Turn PT1 to the right or left to change the preset food type displayed on DSP1.

Press PT1 to validate and the weight light  starts to blink.

Turn PT1 to the right or left to change the preset food weight.



Press PT2 to start the defrosting process.

The defrosting time will be calculated based on the food's type and weight and the microwaves power will be automatically varied to achieve the best thawing results.

The following table shows the defrosting by weight function programmes, indicating weight intervals, and defrosting and standing times (in order to ensure the food is of a uniform temperature).

PROGRAMME	FOOD	WEIGHT (oz)	TIME (MIN)	STANDING TIME (MIN)
PR 01	MEAT	3,5 – 70,5	2 – 43	20 – 30
PR 02	POULTRY	3,5 – 88	2 – 58	20 – 30
PR 03	FISH	3,5 – 88	2 – 40	20 – 30
PR 04	FRUIT	3,5 – 18	2 – 13	10 – 20
PR 05	BREAD	3,5 – 28	2 – 19	10 – 20

9.3.12 Pizza function

After selecting this function **press PT1 to set the parameters and the duration light  starts to blink.** The weight light  starts to blink.

Turn PT1 to the right or left to change the preset Pizza weight.

Press PT2 to start the cooking process.

9.3.13 Delayed Start Time (Automatic cooking)

When PT1 is pressed to define a delayed start time the corresponding light  starts to blink, DSP1 shows the current time and DSP 2 shows "Auto".

Turn PT1 to the right or left to change the delayed start time.

Press PT2 to validate the delayed start time.

The oven enters in an idle state waiting for the defined start time. DSP3 shows the selected function and DSP1 and DSP2 show all the defined parameters for the function continuously alternating.

If you wish to start the function before the selected time, just press PT2.

If you wish to cancel the programming, press PT2 for 3 seconds.



9.4 When the oven is working...

9.4.1 Interrupting a cooking cycle

You can stop the cooking process at any time by pressing the Start/Stop key once or by opening the oven door. In both cases:

- **Microwave emission is stopped immediately.**
- The grill is de-activated but is **still very hot. Danger of burning!**
- The timer stops and the display shows the remaining amount of operating time.

If you wish, at this time you can:

- Turn or stir the food to ensure it will be evenly cooked.
- Modify the process parameters.
- Cancel the process by pressing PT2 for 3 seconds.

To restart the process, close the door and press PT2.

9.4.2 Modifying parameters

The operating parameters (time, weight, power, etc.) can only be modified when the cooking process has been interrupted. Proceed as follows:

- Turn PT2 to the right or left to change the function.
- Press PT1 to activate the parameter modification mode. The **min** symbol starts to blink. Turn PT1 to the right or left to change the remaining cooking duration.
- Press PT1 to validate and the next parameter light starts to blink. Proceed as described in the active function chapter to modify the remaining parameters.
- Press PT2 to continue the cooking process.

9.4.3 Cancelling a cooking cycle

If you wish to cancel the cooking process, press PT2 for 3 seconds.

You will then hear a beep and the oven returns to the OFF setting.

9.4.4 End of a cooking cycle

At the end of the process you will hear three beeps and the display will show the word "End".

The beeps are repeated every 30 seconds until the door is opened or PT2 is pressed. The oven returns to the OFF setting.

9.5 Secondary menu

This appliance also has a concealed "secondary menu" allowing the user to:

1. Activate or deactivate the Show Room function (which disables all the heating elements so that only the control panel works);
2. Activate or deactivate the function which limits the maximum power absorption to 2000 W;
3. Activate or deactivate the child safety device (

9.5.1 Show Room Function

With the oven in OFF status (see point "7.2 Operating settings") keep PT1 pressed until the message OFF SHO appears on DSP1. This means that



the SHOW ROOM function (which disables all the heating elements so that only the control panel works) is not active.

Turn PT1 to the right or left to activate (ON SHO) or deactivate (OFF SHO) this function. To use the oven normally, set OFF SHO.

After setting the parameter required, press PT2 to return the oven to the initial standby status.

9.5.2 **Power selection function**

This function allows the oven operation if there are limitations in the mains power (e.g. 3 kW for Italian market). The cooking results will not be affected but the cooking duration will be increased on some functions that activated more than one heating element.

With the oven in OFF status (see point “7.2 Operating settings”) keep PT1 pressed until the message OFF SHO appears on DSP1. Now press PT1 once again and the message “OFF 2000” will appear on DPS1.

Turn PT1 to the right or left to activate (ON 2000) or deactivate (OFF 2000) this function, which limits the oven's maximum power absorption, in any function, to 2000 W.

After setting the parameter required, press PT2 to return the oven to the initial standby status.

9.5.3 **Child safety lock-out function**

With the oven in OFF status (see point “7.2 Operating settings”) keep PT1 pressed until the message OFF SHO appears on DSP1. Now press PT1 until the message “OFF BLOC” appears on DPS1.

Turn PT1 to the right or left to activate (ON BLOC) or deactivate (OFF BLOC) this function, which locks out all the functions and knobs after 3 minutes of operation without any command from the user (when this system is active, the  symbol appears on DPS2).

After setting the parameter required, press PT2 to return the oven to the initial standby status.

To exit the lockout status temporarily to modify a cooking program or select a different function, keep PT1 pressed until the  symbol disappears from DSP2. The required changes can now be made, and 2 minutes after the last setting is made the lockout will come into operation again.

To deactivate the lockout permanently, access the secondary menu and switch the function off as described in this section.



9.6 Cooling fan system

The appliance is equipped with a cooling system which comes into operation as soon as a cooking function starts.

Operation of the fans generates a normal air flow which comes out above the door and may continue for a short time even after the oven is switched off.

9.7 Inside light

The oven light comes on:

- when the oven door is opened in standby status (point “7.2 Operating settings”) or;
- when the function knob is turned to any function.

If the oven door is left open, the oven light will automatically shut-off after 10 minutes.

10 ACCESSORIES AVAILABLE

Shelf: useful to support pans containing the food for cooking. **DO NOT USE WITH MICROWAVES.**



Glass tray: useful for cooking cakes, pizza and confectionery and for collecting fat from foods placed on the shelf above. The glass tray can only be used over the Shelf or directly onto the cavity floor.



Browning Plate: useful for microwave cooking food that requires bottom heat. It can also be used for frying bacon, eggs, sausages, etc





11 RECOMMENDED COOKING TABLES

11.1 Cooking with Microwaves



Warning! Read the section “Safety Precautions” before cooking with your microwave.

Follow these recommendations when cooking with microwaves:

- Before heating or cooking foods with peel or skin (e.g. apples, tomatoes, potatoes, sausages) prick them so that they do not burst. Cut the food up before starting to prepare it.
- Before using a container or dish make sure that it is suitable for microwave use (see the section on types of ovenware).
- When cooking food with very little moisture (e.g. defrosting bread, making popcorn, etc.) evaporation is very quick. The oven then works as if it was empty and the food may burn. The oven and the container may be damaged in such a situation. You should therefore set just the cooking time necessary and you must keep a close eye on the cooking process.
- It is not possible to heat large quantities of oil (frying) in the microwave.
- Remove pre-cooked food from the containers they come in since these are not always heat resistant. Follow the food manufacturer’s instructions.
- If you have several containers, such as cups, for example, set them out uniformly on the turntable plate.
- Do not close plastic bags with metal clips. Use plastic clips instead. Prick the bags several times so that the steam can escape easily.
- When heating or cooking foods, check that they reach at least a temperature of 158°F.
- During cooking, steam may form on the oven door window and may start to drip. This situation is normal and may be more noticeable if the room temperature is low. The oven’s safe working is not affected by this. After you have finished cooking, clean up the water coming from the condensation
- When heating liquids, use containers with a wide opening, so that the steam can evaporate easily.

Prepare the foods as per the instructions and keep in mind the cooking times and power levels indicated in the tables.

Keep in mind that the figures given are only indicative and can vary depending on the initial state, temperature, moisture and type of food. It is advisable to adjust the times and power levels to each situation. Depending on the exact characteristics of the food you may need to increase or shorten the cooking times or increase or decrease the power levels.



Instructions for the User

USA

Cooking with microwaves...

1. The greater the amount of food, the longer the cooking time. Keep in mind that:

- Double the quantity » double the time
- Half the quantity » half the time

2. The lower the temperature, the longer the cooking time.

3. Foods containing a lot of liquid heat up more quickly.

4. Cooking will be more uniform if the food is evenly distributed on the turntable. If you put dense foods on the outside part of the plate and less dense ones on the centre of the plate, you can heat up different types of food simultaneously.

5. You can open the oven door at any time. When you do this the oven switches off automatically. The microwave will only start working again when you close the door and press the start key.

6. Foods that are covered require less cooking time and retain their characteristics better. The lids used must let microwaves pass through and have small holes that allow steam to escape

11.1.1 Cooking vegetables

FOOD	QUANTITY (oz)	LIQUIDS ADDITION	POWER (W)	TIME (MIN.)	STANDING TIME (MIN.)	INSTRUCTIONS
CAULIFLOWER	18	100 ML	800	9-11	2-3	CUT INTO SLICES.
BROCCOLI	11	50 ML	800	6-8	2-3	
MUSHROOMS	9	25 ML	800	6-8	2-3	KEEP COVERED.
PEAS, CARROTS	11	100 ML	800	7-9	2-3	CUT INTO CHUNKS OR SLICES. KEEP COVERED.
FROZEN CARROTS	9	25 ML	800	8-10	2-3	
POTATOES	9	25 ML	800	5-7	2-3	PEEL AND CUT INTO EQUAL SIZED PIECES. KEEP COVERED.
PAPRIKA	9	25 ML	800	5-7	2-3	CUT INTO CHUNKS OR SLICES KEEP COVERED.
LEEK	9	50 ML	800	5-7	2-3	
FROZEN BRUSSEL SPROUTS	11	50 ML	800	6-8	2-3	KEEP COVERED.

11.1.2 Cooking fish

FOOD	QUANTITY (oz)	POWER (W)	TIME (MIN.)	STANDING TIME (MIN.)	INSTRUCTIONS
FISH FILLETS	18	600	10-12	3	COOK COVERED OVER. TURN AFTER HALF OF COOKING TIME.
WHOLE FISH	28	800 400	2-3 7-9	2-3	COOK COVERED OVER. TURN AFTER HALF OF COOKING TIME. YOU MAY WISH TO COVER UP THE SMALL EDGES OF THE FISH.



11.1.3 11.1.3 Using the browning plate

Normally when cooking food, such as pizzas or pies, on a grill or in a microwave oven, the dough or pastry becomes soggy. This can be avoided by using a browning plate. As a high temperature is reached quickly on the bottom of the browning plate, the crust turns crisp and brown.

The browning plate can also be used for bacon, eggs, sausages, etc.

VERY IMPORTANT NOTES:

- Use oven gloves at all times as the browning plate will become very hot.
- Never place the browning plate in the oven without the glass plate.
- Do not place any recipients on the browning plate that are not heat-resistant (plastic bowls for example).

How to cook with the browning plate:

1. Preheat the browning plate by selecting the Microwave and Grill function for 3 to 5 minutes with a 600 W microwaves power level.
2. Brush the browning plate with oil in order to brown the food nicely.
3. Place the fresh or frozen food directly on the browning plate.
4. Place the browning plate on the glass turntable in the microwave oven.
5. Select the Microwaves and Grill function and the cooking time as described below.

FOOD	WEIGHT (oz)	COOKING TIME (MIN)	STANDING TIME (MIN)	RECOMMENDATION
PIZZA	6-7	4 - 5	---	IF THE PIZZA IS THIN. IF THE PIZZA IS HIGH INCREASE THE TIME BY 1 – 2 MINUTES
	10-11	5 - 6	---	
	13-15	7 – 8	---	
QUICHES AND PIES	6-7	3 – 4	2 – 3	
	10-11	5 - 6	2 – 3	
HAMBURGERS	5-8	8 - 10	5 – 8	
OVEN CHIPS	14	6 - 8	---	TURN 2 X

VERY IMPORTANT NOTES:

As the browning plate has a Teflon layer, if you use it incorrectly, it can be damaged.

Never cut the food on the plate. Remove the food from the plate prior to cutting.

Cleaning:

The best way to clean the browning plate is to wash it with hot water and detergent and rinse off with clean water. Do not use a scrubbing brush or a hard sponge otherwise the top layer will be damaged.

11.1.4 Defrosting with Microwaves



General instructions for defrosting

1. When defrosting, use only dishes that are appropriate for microwaves (china, glass, suitable plastic).



Instructions for the User

USA

2. The defrost function by weight and the tables refer to the defrosting of raw food.
3. The defrosting time depends on the quantity and thickness of the food. When freezing food keep the defrosting process in mind. Distribute the food evenly in the container.
4. Distribute the food as best as possible inside the oven. The thickest parts of fish or chicken drumsticks should be turned towards the outside. You can protect the most delicate parts of food with pieces of aluminium foil. Important: The aluminium foil must not come into contact with the oven cavity interior as this can cause electrical arcing.
5. Thick portions of food should be turned several times.
6. Distribute the frozen food as evenly as possible since narrow and thin portions defrost more quickly than the thicker and broader parts.
7. Fat-rich foods such as butter, cream cheese and cream should not be completely defrosted. If they are kept at room temperature they will be ready to be served in a few minutes. With ultra-frozen cream, if you find small pieces of ice in it, you should mix these in before serving.
8. Place poultry on an upturned plate so that the meat juices can run off more easily.
9. Bread should be wrapped in a napkin so that it does not become too dry.
10. Turn the food whenever the oven lets out a beep and the DSP1 displays the word: `t u r n` .
11. Remove frozen food from its wrapping and do not forget to take off any metal twist-tags. For containers that are used to keep frozen food in the freezer and which can also be used for heating and cooking, all you need to do is take off the lid. For all other cases you should put the food into containers that are suitable for microwave use.
12. The liquid resulting from defrosting, principally that from poultry, should be discarded. In no event should such liquids be allowed to come into contact with other foods.
13. Do not forget that by using the defrosting function you need to allow for standing time until the food is completely defrosted.

Instructions for the User



The table below shows different defrosting and standing times (in order to ensure the food temperature is evenly distributed) for different types and weights of food, plus recommendations.

FOOD	WEIGHT (oz)	DEFROSTING TIME (MIN)	STANDING TIME (MIN)	RECOMMENDATION
PORTIONS OF MEAT, VEAL, BEEF, PORK	3-4	2-3	5-10	TURN ONCE
	6-7	4-5	5-10	TURN ONCE
	17-18	10-12	10-15	TURN TWICE
	34-36	21-23	20-30	TURN TWICE
	51-53	32-34	20-30	TURN TWICE
	70-71	43-45	25-35	TURN THREE TIMES
GOULASH	17-18	8-10	10-15	TURN TWICE
	34-36	17-19	20-30	TURN THREE TIMES
MINCED MEAT	3-4	2-4	10-15	TURN TWICE
	17-18	10-14	20-30	TURN THREE TIMES
SAUSAGES	6-7	4-6	10-15	TURN ONCE
	17-18	9-12	15-20	TURN TWICE
POULTRY (PORTIONS) CHICKEN	8-9	5-6	5-10	TURN ONCE
	34-36	20-24	20-30	TURN TWICE
POULARDE	88-89	38-42	25-35	TURN THREE TIMES
FISH FILLET	6-7	4-5	5-10	TURN ONCE
TROUT	8-9	5-6	5-10	TURN ONCE
PRAWNS	3-4	2-3	5-10	TURN ONCE
	17-18	8-11	15-20	TURN TWICE
	FRUIT	6-7	4-5	5-10
	10-11	8-9	5-10	TURN ONCE
	17-18	11-14	10-20	TURN TWICE
BREAD	7-8	4-5	5-10	TURN ONCE
	17-18	10-12	10-15	TURN ONCE
	27-29	15-17	10-20	TURN TWICE
BUTTER	8-9	8-10	10-15	
CREAM CHEESE	8-9	6-8	10-15	
CREAMS	8-9	7-8	10-15	



Instructions for the User

USA

11.2 Cooking with the Grill Element

For good results with the grill, use the rack supplied with the oven.

Fit the rack in such a way that it doesn't come into contact with the metal surfaces of the oven cavity since if it does there is a danger of electric arcing which may damage the oven.

IMPORTANT POINTS:

1. When the grill is used for the first time there will be some smoke and a smell coming from the oils used during oven manufacture.
2. The oven door window becomes very hot when the grill is working. Keep children away.
3. When the grill is operating, the cavity walls and the grid iron become very hot. You should use oven gloves.
4. If the grill is used for extended period of time it is normal to find that the elements will switch themselves off temporarily due to the safety thermostat.
5. Important! When food is to be grilled or cooked in containers you must check that the container in question is suitable for microwave use. See the section on types of ovenware!
6. When the grill is used it is possible that some splashes of fat may go onto the elements and be burnt. This is a normal situation and does not mean there is any kind of operating fault.
7. After you have finished cooking, clean the interior and the accessories so that cooking remains do not become encrusted.

11.2.1 Grill Element



FISH	QUANTITY (oz)	TIME (MIN.)	INSTRUCTIONS
FISH			
BASS	29	18-24	SPREAD LIGHTLY WITH BUTTER. AFTER HALF OF COOKING TIME TURN AND SPREAD WITH SEASONING.
SARDINES/GURNARD	6-8 FISH.	15-20	
MEAT			
SAUSAGES	6-8 UNITS	22-26	PRICK AFTER HALF COOKING TIME AND TURN.
FROZEN HAMBURGERS	3 UNITS	18-20	
SPARE RIB (APPROX. 3 CM THICK)	14	25-30	AFTER HALF OF COOKING TIME, BASTE AND TURN.
OTHERS			
TOAST	4 UNITS	1½-3	WATCH TOASTING.
TOASTED SANDWICHES	2 UNITS	5-10	WATCH TOASTING.

Heat up the grill beforehand for 2 minutes. Unless indicated otherwise, use the rack. Place a tray below the rack so that the water and the fat can drop. The times shown are merely indicative and can vary as a function of the composition and quantity of the food, as well as the final condition wished for. Fish and meat taste great if, before grilling, you brush them with vegetable oil, spices and herbs and leave to marinate for a few hours. Only add salt after grilling.



Sausages will not burst if you prick them with a fork before grilling. After half the grilling time has passed, check on how the cooking is going and, if necessary, turn the food over.

The grill is especially suitable for cooking thin portions of meat and fish. Thin portions of meat only need to be turned once, but thicker portions should be turned several times. Heat up the grill beforehand for 2 minutes.

11.2.2 Grill Element + Fan

The fan reduces the fierce heat from the grill, providing an excellent method for grilling a range of foods, chops, steaks, sausages, etc. without having to turn the food during cooking. This gives good results, reduces drying out of foods and gives even browning and heat distribution.

11.2.3 Microwaves + Grill Element

The microwave + grill function is ideal for cooking quickly and, at the same time, browning foods. Furthermore, you can also grill and cook cheese covered food.

The microwave and the grill work simultaneously. The microwave cooks and the grill toasts.

FOOD	QUANTITY (oz)	DISH	POWER (W)	TIME (MIN.)	STANDING TIME (MIN.)
CHEESE TOPPED PASTA	17-18	LOW DISH	400	12-17	3-5
CHEESE TOPPED POTATOES	28	LOW DISH	600	20-22	3-5
LASAGNE	APPROX. 28	LOW DISH	600	15-20	3-5
GRILLED CREAM CHEESE	APPROX. 17-18	LOW DISH	400	18-20	3-5
2 FRESH CHICKEN LEGS (GRILLED)	7 EACH	LOW DISH	400	10-15	3-5
CHICKEN	APPROX. 35-36	LOW AND WIDE DISH	400	35-40	3-5
CHEESE TOPPED ONION SOUP	2 X 7 OZ CUPS	SOUP BOWLS	400	2-4	3-5

Before using a dish in the microwave oven make sure that it is suitable for microwave use. Only use dishes or containers that are suitable for microwave use.

The dish to be used in the combined function must be suitable for microwave and grill use. See the section on types of ovenware!

Keep in mind that the figures given are merely indicative and can vary as a function of the initial state, temperature, moisture and type of food.

If the time is not enough to brown the food well, put it under the grill for another 5 or 10 minutes.

Please follow the standing times and don't forget to turn the meat pieces.

Unless indicated to the contrary, use the turntable plate for cooking.

The values given in the tables are valid when the oven cavity is cold (it is not necessary to pre-heat the oven).



Instructions for the User

USA

11.3 Cooking with the Round Heating Element

11.3.1 Round Heating Element + Fan

The combination of the fan and round heating element around it, gives uniform heat distribution with no cold spots. This results in many benefits – no flavour transfer when cooking different foods at the same time, less energy is needed, and it cooks at 10% quicker than a normal oven. All foods can be cooked with this function.

IMPORTANT POINTS:

1. When the round heating element is used for the first time there will be some smoke and a smell coming from the oils used during oven manufacture.
2. The oven door window becomes very hot when the oven is working. Keep children away.
3. When the oven is operating, the cavity walls and the ovenware become very hot. You should use oven gloves.
4. Important! When food is to be cooked in containers you must check that the container in question is suitable for microwave use. See the section on types of ovenware!
5. After you have finished cooking, clean the interior and the accessories so that cooking remains do not become encrusted.

Roasting

FOOD	QUANTITY (OZ)	POWER (W)	TEMP. (°F)	TIME (MIN.)	STANDING TIME (MIN.)	COMMENTS
BEEF STEW	35-36	200	320/340	80/90	10	DO NOT PUT LID ON CONTAINER
PORK LOIN	17/21	200	356/375	35/40	10	DO NOT PUT LID ON CONTAINER
WHOLE CHICKEN	35/43	400	390	35/45	10	PUT LID ON CONTAINER. BREAST FACING UPWARDS. DO NOT TURN.
CHICKEN PORTIONS	28	400	390	30/40	10	DO NOT PUT LID ON CONTAINER. ARRANGE PORTIONS WITH SKIN FACING UPWARDS. DO NOT TURN.
DUCK	52/60	200	390	80/90	10	PUT LID ON CONTAINER. DO NOT TURN.

Advice for roasting meat

Turn the pieces of meat halfway through the cooking time. When the roasted meat is ready you should let it stand for 10 minutes in the oven with this switched off and closed. This will ensure the juices in the meat are well distributed.

Add 2 to 3 soup spoons of gravy or similar liquid to lean meat and 8 to 10 soup spoons to stews, depending on the amount of meat in question.

The roasting temperature and time required depends on the type and amount of meat being cooked.



If the weight of the meat to be roasted does not appear on the table choose the settings for the weight immediately below and extend the cooking times.

Advice on ovenware

Check that the ovenware fits inside the oven.

Hot glass containers should be put on a dry kitchen cloth. If such containers are put on a cold or wet surface the glass may crack and break. Use oven gloves to take the ovenware out of the oven.

Baking

TYPE	CONTAINER	LEVEL	TEMPERAT. (°F)	TIME (MIN)
WALNUT CAKE	SPRING-FORM TYPE TIN	1	338/356	30/35
FRUIT TART	SPRING-FORM TYPE TIN	2	302/320	35/45
FRUIT CAKES	CAKE TIN WITH CENTRAL HOLE	1	338/374	30/45
SAVOURY TARTS	SPRING-FORM TYPE TIN	2	320/356	50/70
SIMPLE CAKE (SPONGE CAKE)	SPRING-FORM TYPE TIN	1	320/338	40/45
ALMOND CAKES	CAKE TRAY	2	230	35/45
PUFF PASTRY	CAKE TRAY	2	338/356	35/45

Advice on cake baking ware

The most commonly used type of baking ware is black metal tins. If you are also going to use the microwave, use glass, ceramic or plastic baking ware. These must be able to withstand temperatures up to 250°C. If you use these types of baking ware the cakes are not browned as much.

Advice on how to bake cakes

Different amounts and types of pastry require different temperatures and baking times. Try low settings first of all and then, if necessary, use higher temperatures next time. A lower temperature will result in more uniform baking. Always put the cake tray in the centre of the turntable.

Baking suggestions

How to check if the cake is properly cooked

Start sticking a tooth pick in the highest part of the cake 10 minutes before the end of the baking time. When no dough sticks to the tooth pick the cake is ready.

If the cake is very dark on the outside

Next time choose a lower temperature and let the cake bake for a longer time.

If the cake is very dry

Make small holes in the cake with a tooth pick after baking has finished. Then sprinkle the cake with some fruit juice or alcoholic drink. Next time increase the temperature by about 50°F and reduce the baking time.

If the cake does not come free when turned

Let the cake cool down for 5 to 10 minutes after baking and it will come out of the tin more easily. If the cake still does not come free run a knife carefully around the edges. Next time grease the cake tin well.



Instructions for the User

USA

Advice on saving energy

When you are making more than one cake, it is advisable to bake them in the oven one after the other when the oven is still hot. This lets you reduce the baking time for the second and later cakes.

It is preferable to use dark coloured baking ware - painted or enamelled black – since such baking tins absorb heat better.

When dealing with long baking times, you can switch the oven off 10 minutes before the end of the time and make use of the residual heat to complete the baking.

11.3.2 **Microwaves + Round Heating Element + Fan**

The use of microwaves with round heating element and the fan allows the food to be cooked faster and effectively. Ideal for roasting large chunks of meat. There is no transference of smells or flavours when using this function.

11.3.3 **Grill Element + Round Heating Element + Fan**

The use of the fan with both elements allows the food to be cooked quickly and effectively. Ideal for roasts and large joints that require thorough cooking. There is no transference of smells or flavours when using this function. This function offers a similar result to rotisserie, it moves the heat around the food, instead of moving the food itself, enabling any size or shape to be cooked, and not only items that will fit onto a rotisserie.

11.4 **Pizza Function**

Warning! Read the section “Using the browning plate” before cooking with the Pizza function.

It is not necessary to pre-heat the browning plate to cook Pizzas.

Place the pizza directly on the browning plate.

Place the browning plate on the centre of the glass turntable in the microwave oven.

Warning: the cavity walls and the browning plate become very hot. Care should be taken to avoid touching heating elements, cavity walls or the browning plate. The use of oven gloves is highly recommended to avoid burns.



11.5 What kind of ovenware can be used?

11.5.1 Microwaves function

For the microwave function, keep in mind that microwaves are reflected by metal surfaces. Glass, china, clay, plastic, and paper let microwaves pass. For this reason, metal pans and dishes or containers with metal parts or decorations cannot be used in the microwave. Glass ware and clay with metallic decoration or content (e.g. lead crystal) cannot be used in microwave ovens.

The ideal materials for use in microwave ovens are glass, refractory china or clay, or heat resistant plastic. Very thin, fragile glass or china should only be used for short period of times (e.g. heating).

Hot food transmits heat to the dishes which can become very hot. You should, therefore, always use an oven glove!

To test ovenware, put the item you want to use in the oven for 20 seconds at maximum microwave power. After that time, if it is cold or just slightly warm, it is suitable to use. However, if it heats up a lot or causes electric arcing it is not suitable for microwave use.

11.5.2 Grill Element and Round Heating Element functions

In the case of the grill function, the ovenware must be resistant to temperature of at least 572°F.

Plastic dishes are not suitable for use in the grill.

11.5.3 Combination functions

In the combination functions (microwaves + conventional heating elements), the ovenware used must be suitable for use in both the microwave and the grill.

11.5.4 Aluminium containers and foil

Pre-cooked food in aluminium containers or in aluminium foil can be put in the microwave if the following aspects are respected:

- Keep in mind the manufacturer's recommendations written on the packaging.
- The aluminium containers cannot be more than 3 cm high or come in contact with the cavity walls (**minimum distance 3 cm**). Any aluminium lid or top must be removed.
- Put the aluminium container directly on top of the turntable plate. If you use the grid iron, put the container on a china plate. Never put the container directly on the grid iron!
- The cooking time is longer because the microwaves only enter the food from the top. If you have any doubts, it is best to use only dishes suitable for microwave use.
- Aluminium foil can be used to reflect microwaves during the defrosting process. Delicate food, such as poultry or minced meat, can be protected from excessive heat by covering the respective extremities/edges.
- **Important:** aluminium foil cannot come into contact with the cavity walls since this may cause electrical arcing.



Instructions for the User

USA

11.5.5 Lids

We recommend you use glass or plastic lids or cling film since:

1. This will stop excessive evaporation (mainly during very long cooking times);
2. The cooking times are shorter;
3. The food does not become dry;
4. The aroma is preserved.

The lid should have holes or openings so that no pressure develops. Plastic bags must also be opened. Baby feeding bottles or jars with baby food and similar containers can only be heated without their tops / lids otherwise they can burst.

The table below gives you a general idea of what type of ovenware is suitable for each situation.

OPERATINGMODE TYPEOF OVENWARE	MICROWAVE		GRILL	MICROWAVE + GRILL
	DEFROSTING / HEATING	COOKING		
<u>GLASS AND CHINA 1)</u> HOME USE, CAN BE USED IN DISH WASHER, NOT FLAME RESISTANT	YES	YES	NO	NO
<u>GLAZED CHINA</u> FLAME RESISTANT GLASS AND CHINA	YES	YES	YES	YES
<u>CHINA, STONE WARE 2)</u> UNGLAZED OR GLAZED WITHOUT METALLIC DECORATIONS	YES	YES	NO	NO
<u>CLAY DISHES 2)</u> GLAZED	YES	YES	NO	NO
UNGLAZED	NO	NO	NO	NO
<u>PLASTIC DISHES 2)</u> HEAT RESISTANT TO 100°C	YES	NO	NO	NO
HEAT RESISTANT TO 250°C	YES	YES	NO	NO
<u>PLASTIC FILMS 3)</u> PLASTIC FILM FOR FOOD	NO	NO	NO	NO
CELLOPHANE	YES	YES	NO	NO
<u>PAPER, CARDBOARD, PARCHMENT 4)</u>	YES	NO	NO	NO
<u>METAL</u> ALUMINIUM FOIL	YES	NO	YES	NO
ALUMINIUM WRAPPINGS 5)	NO	YES	YES	YES
ACCESSORIES (GRID IRON)	NO	NO	YES	YES

1. Without any gold or silver leaf edging; no lead crystal.
2. Keep the manufacturer's instructions in mind!
3. Do not use metal clips for closing bags. Make holes in the bags. Use the films only to cover the food.
4. Do not use paper plates.
5. Only shallow aluminium containers without lids/tops. The aluminium cannot come into contact with the cavity walls.



12 CLEANING AND MAINTENANCE



Before carrying out any operations, disconnect the appliance from the electricity supply. Take the plug out of the socket or switch off the oven's power circuit.



Warning! Never use a jet of steam for cleaning the inside of the oven.



Warning! Your microwave oven should be cleaned regularly, with all food remains being removed. If the microwave is not kept clean its surfaces may deteriorate, reducing the oven's working life and possibly resulting in a dangerous situation.

12.1 Cleaning stainless steel



To keep stainless steel in good condition, it must be cleaned regularly, after each use of the oven, after allowing it to cool.

12.2 Routine daily cleaning

When cleaning and caring for stainless steel surfaces, always use **only** specific products which do not contain abrasives or chlorine-based acids.

Instructions for use: pour the product onto a damp cloth and wipe over the surface, then rinse thoroughly and dry with a soft cloth or chamois leather.

12.3 Food stains or spills

Never use metal scouring pads or sharp scrapers which will damage the surface.

Use ordinary non-abrasive products with the aid of wooden or plastic utensils if necessary. Rinse thoroughly and dry with a soft cloth or chamois leather.

Do not allow spills of foods with high sugar content (e.g. jam) to dry inside the oven. If they dry for too long, they might damage the enamel coating of the inside of the oven.

Do not use harsh abrasive cleaners or sharp metal scrapers to clean the oven door glass since they can scratch the surface, which may result in shattering of the glass.



12.4 Cleaning the oven cavity

Cleaning is the only maintenance normally required.

After each time the oven is used, clean the inside walls with a damp cloth since this is the easiest way to remove splashes or spots of food that may have stuck to the inside.



Instructions for the User

USA

To remove dirt that is harder to shift, use a non-aggressive cleaning product. Do not use oven sprays or other aggressive or abrasive cleaning products.

Always keep the door and the oven front very clean to ensure that the door opens and closes properly.

Make sure water does not enter the microwave ventilation holes.

Regularly take out the turntable plate and the respective support and clean the cavity base, especially after any liquid spillage.

Do not switch on the oven without the turntable and the respective support being in place.

If the oven cavity is very dirty, put a glass of water on the turntable and switch on the microwave oven for 2 or 3 minutes at maximum power. The steam released will soften the dirt which can then be cleaned easily using a soft cloth.

Unpleasant odours (e.g. after cooking fish) can be eliminated easily. Put a few drops of lemon juice in a cup with water. Put a spoonful of coffee in the cup to avoid the water boiling over. Heat the water for 2 to 3 minutes at maximum microwave power.

12.5 Cleaning the cavity ceiling

If the oven ceiling is dirty, the grill can be lowered to make cleaning easier.

To avoid the danger of burning, wait until the grill is cold before lowering it.

Proceed as follows:

1. Turn the grill support by 356° (1).
2. Lower the grill gently (2). **Do not use excessive force as this may cause damage.**
3. After cleaning the ceiling, put the grill (2) back in its place, carrying out the previous operation.

IMPORTANT WARNING: The grill heating element support (1) may fall when it is rotated. If this happens, insert the grill heating element support (1) into the slot in the ceiling of the cavity and rotate it 90° to the grill heating element support (2) position.

The mica cover (3) located in the ceiling must always be kept clean. Any food remains that collect on the mica cover can cause damage or provoke sparks.

Do not use abrasive cleaning products or sharp objects.

To avoid any risk, do not remove the mica cover.

The glass lamp cover (4) is located on the oven ceiling and can be removed easily for cleaning. For this you just need to unscrew it and clean it with water and dishwashing liquid.

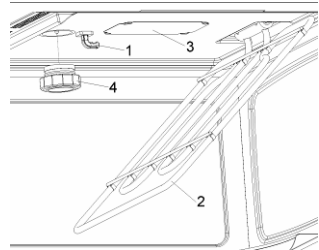

12.6 Cleaning the accessories

Clean the accessories after each use. If they are very dirty, soak them first of all and then use a brush and sponge. The accessories can be washed in a dish washing machine.

Make sure that the turntable plate and the respective support are always clean. Do not switch on the oven unless the turntable and the respective support are in place.



13 EXTRAORDINARY MAINTENANCE

Occasionally, the oven will require minor servicing procedures or the replacement of parts subject to wear and tear, such as gaskets, light bulbs, etc. The specific operations for each procedure of this kind are provided below.



Before carrying out any operation involving access to live parts, disconnect the appliance from the electricity supply.

13.1 Changing the light bulb

To change the light bulb, proceed as follows:

- Unscrew and remove the glass light cover (1).
- Remove the halogen light bulb (2). Warning! The bulb may be very hot.
- Fit a new 12V / 10W halogen bulb. Warning! Do not touch the light bulb surface directly with your fingers because you may damage the bulb. Follow the lamp manufacturer's instructions.
- Screw the glass light cover into place (1).
- Connect the oven again to the power supply.

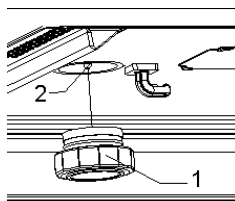

13.2 What should I do if the oven doesn't work?

WARNING! Any type of repair must only be done by a specialised technician. Any repair done by a person not authorised by the manufacturer is dangerous.

You do not need to contact Technical Assistance to resolve the following questions.

The display is not showing! Check if:

- The time indication has been switched off (see section on Basic Settings).

Nothing happens when I press the keys! Check if:

- The Safety Block is active (see section on Basic Settings).

The oven does not work! Check if:

- The plug is correctly fitted in the socket.
- The oven's power is switched on.
- The door is completely closed. The door should close with an audible click.
- There are any foreign bodies between the door and the cavity front.



Instructions for the User

USA

When the oven is operating I can hear some strange noises! Check if:

- There is any electrical arcing inside the oven caused by foreign metallic objects (see section on type of ovenware).
- The ovenware is touching the oven walls.
- There are any loose items of cutlery or cooking tools inside the oven.

The food doesn't heat up or heats very slowly! Check if:

- You have inadvertently used metal ovenware.
- You have selected the correct operating times and power level.
- The food you have put inside the oven is a larger amount or colder than you usually put in.

The food is too hot, dried out or burnt! Check if:

- You selected the correct operating time and power level.

I hear some noises after the cooking process is finished!

- This is not a problem. The cooling fan keeps on working for some time. When the temperature has dropped sufficiently, the fan will switch itself off.

The oven switches on but the interior light does not go on!

- If all the functions work properly it is probable that the lamp has blown. You can keep on using the oven.



14 INSTALLING THE APPLIANCE

14.1 Electrical connection



The nameplate with the technical data, serial number and mark is in a visible position on the oven door frame.

The nameplate must never be removed.



The appliance must be connected to earth in compliance with electrical system safety regulations.



If a permanent connection is used, the appliance's power supply line must be fitted with an omnipolar breaking device with contact gap of at least **3 mm**, located in an easily accessible position close to the appliance itself.



If a socket and plug connection is used, check that they are of the same type. Do not use reducers, adapters or junctions since they may cause overheating or burns.



14.2 Positioning the oven

The appliance is designed for building-in to cabinets made from any heat-resistant material. Comply with the dimensions shown in following pictures. When installing in tall units bear in mind that the top/rear of the unit must have an opening 100 mm deep.

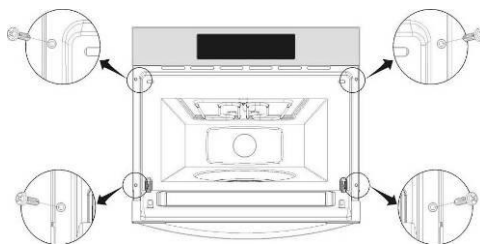
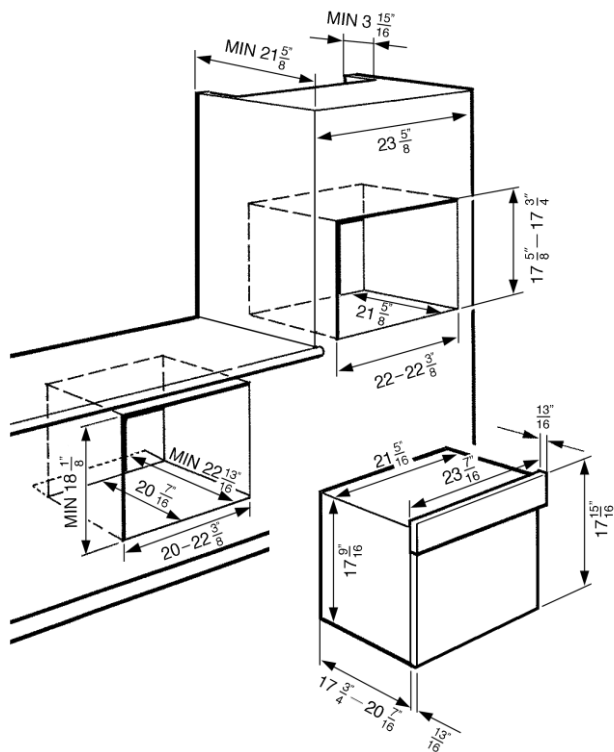

EN

- Push oven completely into the cabinet and centre it.
- Open microwave door and fasten the appliance to the cabinet using the four screws provided. Insert the screws through the front holes.

SMEG USA INC,
150E 58TH STREET 7TH FLOOR
NEW YORK - NY 10155
TEL. +1 212 265 5378
FAX +1 212 265 5945



C6d: 1630324