

MXZ-SM60NAM-U1 5-TON MULTI-ZONE INVERTER HEAT-PUMP SYSTEM



Job Name:

System Reference:

Date:

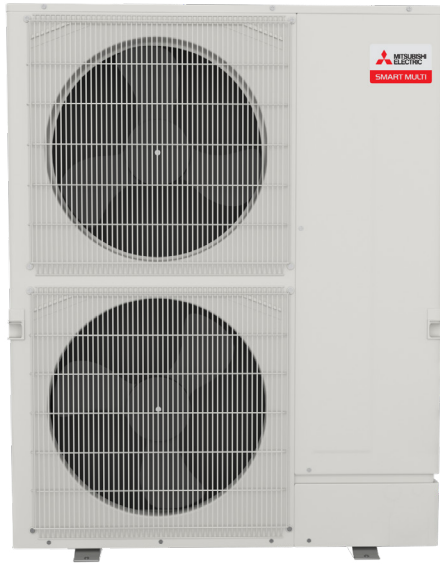

FEATURES

- Compatible with M- and P-Series and CITY MULTI indoor units. Branch box required for connection with M- and P-Series
- Variable speed INVERTER-driven compressor
- Seacoast protection on heat exchanger and base panel (rated for 2,000 hrs in accordance with ASTM B117 testing)
- Thermal Differential 1°F (with PAC-MKA32/52BC only)
- Optional base pan heater
- Quiet outdoor unit operation, rated sound pressure as low as 58 dB(A)
- High pressure protection
- Compressor thermal protection
- Compressor overcurrent detection
- Fan motor overheating/voltage protection

ENERGY STAR products are third-party certified by an EPA-recognized Certification Body.

Specifications are subject to change without notice.

© 2022 Mitsubishi Electric Trane HVAC US LLC. All rights reserved.

SPECIFICATIONS: MXZ-SM60NAM-U1

Cooling ¹ (Non-Ducted // Mix // Ducted)	Maximum Capacity	BTU/H	60,000 // 60,000 // 60,000	
	Rated Capacity	BTU/H	60,000 // 60,000 // 60,000	
	Minimum Capacity	BTU/H	30,000 // 30,000 // 30,000	
	Maximum Power Input	W	4,510 // 4,920 // 5,405	
	Rated Power Input	W	4,510 // 4,920 // 5,405	
	Power Factor (208V, 230V)	%	98.9, 98.9 // 98.9, 98.9 // 98.9, 98.9	
Heating at 47°F ² (Non-Ducted // Mix // Ducted)	Maximum Capacity	BTU/H	65,000 // 65,000 // 65,000	
	Rated Capacity	BTU/H	66,000 // 66,000 // 66,000	
	Minimum Capacity	BTU/H	31,000 // 31,000 // 31,000	
	Maximum Power Input	W	4,720 // 4,960 // 5,230	
	Rated Power Input	W	4,720 // 4,960 // 5,230	
	Power Factor (208V, 230V)	%	98.9, 98.9 // 98.9, 98.9 // 98.9, 98.9	
Heating at 17°F ³ (Non-Ducted // Mix // Ducted)	Maximum Capacity	BTU/H	65,000 // 65,000 // 65,000	
	Rated Capacity	BTU/H	41,500 // 41,500 // 41,500	
	Maximum Power Input	W	8,280 // 9,300 // 4,510	
	Rated Power Input	W	4,190 // 4,380 // 4,570	
Heating at 5°F ⁴ (Non-Ducted // Mix // Ducted)	Maximum Capacity	BTU/H	57,000 // 57,000 // 57,000	
	Maximum Power Input	W	8,355 // 8,570 // 8,795	
Efficiency (Non-Ducted // Mix // Ducted)	SEER		20.0 // 18.9 // 17.8	
	EER ¹		13.3 // 12.2 // 11.1	
	HSPF (IV)		12.0 // 11.3 // 10.7	
	COP at 47°F ²		4.1 // 3.9 // 3.7	
	COP at 17°F at Maximum Capacity ³		2.3 // 2.0 // 1.9	
	COP at 5°F at Maximum Capacity ⁴		2.0 // 1.95 // 1.9	
	ENERGY STAR [®] Certified		Yes // No // No	
Electrical	Voltage, Phase, Frequency		208/230, 1, 60	
	Guaranteed Voltage Range	V AC	187-253	
	Voltage: Indoor - Outdoor, S1-S2	V AC	208/230	
	Voltage: Indoor - Outdoor, S2-S3	V DC	24	
	Short-circuit Current Rating (SCCR)	kA	5	
	Recommended Fuse/Breaker Size if Branch Box Powered by Outdoor Unit	A	50	
	Recommended Fuse/Breaker Size without Branch Box or Branch Box Powered Separate	A	40	
	Recommended Wire Size (Indoor - Outdoor)	AWG	16	
	MCA if Branch Box Powered by Outdoor Unit	A	46.0	
	MCA without Branch Box or Branch Box Powered Separate	A	36	
	MOCP if Branch Box Powered by Outdoor Unit	A	55	
	MOCP without Branch Box or Branch Box Powered Separate	A	50	
	Fan Motor Full Load Amperage	A	0.8+0.8	
	Fan Motor Output	W	200	
Outdoor unit	Airflow Rate (Cooling / Heating)	CFM	4,875 / 4,555	
	Refrigerant Control		LEV	
	Defrost Method		Reverse Cycle	
	Heat Exchanger Type		Plate fin coil	
	Heat Exchanger Coating		Blue Fin Coating	
	Sound Pressure Level, Cooling ¹	dB(A)	58	
	Sound Pressure Level, Heating ²	dB(A)	59	
	Compressor Type		Hermetic	
	Compressor Model		ANB52FYDMT	
	Compressor Motor Output	kW	3.9	
	Compressor Rated Load Amps	A	19	
	Compressor Locked Rotor Amps	A	22.0	
	Compressor Oil Type // Charge	oz.	FVC68D // 78	
	Base Pan Heater		Optional (PAC-SJ20BH-E)	
	Unit Dimensions	W: In. [mm]		41-11/32[1,050]
		D: In. [mm]		13[330]
		H: In. [mm]		52-11/16[1,338]
	Package Dimensions	W: In. [mm]		43 [1,090]
		D: In. [mm]		18 [450]
		H: In. [mm]		57 [1,430]
Unit Weight	Lbs.[kg]		302 [137]	
Package Weight	Lbs.[kg]		326 [148]	

NOTES:

AHRI Rated Conditions (Rated data is determined at a fixed compressor speed)	¹ Cooling (Indoor // Outdoor)	°F	80 DB, 67 WB // 95 DB, 75 WB
	² Heating at 47°F (Indoor // Outdoor)	°F	70 DB, 60 WB // 47 DB, 43 WB
	³ Heating at 17°F (Indoor // Outdoor)	°F	70 DB, 60 WB // 17 DB, 15 WB
Conditions	⁴ Heating at 5°F (Indoor // Outdoor)	°F	70 DB, 60 WB // 5 DB, 4 WB

*Applications should be restricted to comfort cooling only; equipment cooling applications are not recommended for low ambient temperature conditions.

^A when 1 or more PLA-A-EA7 connected

^B Branch box should be placed within the level between the outdoor unit and indoor units

^C 5°F DB - 115°F DB when optional wind baffles are installed

For actual capacity performance based on indoor unit type and number of indoor units connected, please refer to MXZ Operational Performance.

Although the maximum connectable capacity is 130%, the outdoor unit cannot provide more than 100% of the rated capacity. Please utilize this over capacity capability for load shedding or applications where it is known that all connected units will NOT be operating at the same time.

SPECIFICATIONS: MXZ-SM60NAM-U1

Outdoor unit operating temperature range	Cooling Intake Air Temp (Maximum / Minimum)	°FDB	115 / 23
	Cooling Thermal Lock-out / Re-start Temperatures	°FDB	N/A / N/A
	Heating Intake Air Temp (Maximum / Minimum)	°FWB	59 / -13
	Heating Thermal Lock-out / Re-start Temperatures	°FDB	-24 / -14
Refrigerant	Type		R410A
	Charge	Lbs, oz	11, 4.0
Indoor unit connection	Maximum Number of Connected IDU with Branch Box		8 (6) ^A
	Maximum Number of Connected IDU without Branch Box		12
	Minimum Number of Connected IDU with Branch Box		2
	Minimum Number of Connected IDU without Branch Box		1
	Minimum Connected Capacity with Branch Box	BTU/H	12,000
	Maximum Connected Capacity	BTU/H	78,000
Piping	Liquid Pipe Size O.D. (Flared)	In.[mm]	3/8 [9.52]
	Gas Pipe Size O.D. (Flared)	In.[mm]	3/4 [19.05]
	Total Piping Length when using Branch Box	Ft. [m]	492 [150]
	Total Piping Length without Branch Box	Ft. [m]	492 [150]
	Maximum Height Difference ^B , ODU above IDU	Ft. [m]	164 [50]
	Maximum Height Difference ^B , ODU below IDU	Ft. [m]	131 [40]
	Maximum Height Difference ^B , between branch boxes	Ft. [m]	49 [15]
	Maximum Height Difference ^B , between branch boxes and IDU	Ft. [m]	49 [15]
	Maximum Height Difference between IDU and IDU without branch box	Ft. [m]	49 [15]
	Max. Piping Length between ODU and Branch Box	Ft. [m]	180 [55]
	Farthest Piping Length from ODU to IDU with Branch Box	Ft. [m]	262 [80]
	Farthest Piping Length from ODU to IDU without Branch Box	Ft. [m]	262 [80]
	Farthest Piping Length after Branch Box	Ft. [m]	82 [25]
	Total Piping Length between Branch Boxes and IDU	Ft. [m]	311 [95]
Maximum Number of Bends for IDU		15	

NOTES:

AHRI Rated Conditions (Rated data is determined at a fixed compressor speed)

¹ Cooling (Indoor // Outdoor)	°F	80 DB, 67 WB // 95 DB, 75 WB
² Heating at 47°F (Indoor // Outdoor)	°F	70 DB, 60 WB // 47 DB, 43 WB
³ Heating at 17°F (Indoor // Outdoor)	°F	70 DB, 60 WB // 17 DB, 15 WB

Conditions ⁴Heating at 5°F (Indoor // Outdoor) °F 70 DB, 60 WB // 5 DB, 4 WB

^AApplications should be restricted to comfort cooling only; equipment cooling applications are not recommended for low ambient temperature conditions.

^A when 1 or more PLA-A-EA7 connected

^B Branch box should be placed within the level between the outdoor unit and indoor units

^C 5°F DB - 115°F DB when optional wind baffles are installed

For actual capacity performance based on indoor unit type and number of indoor units connected, please refer to MXZ Operational Performance.

Although the maximum connectable capacity is 130%, the outdoor unit cannot provide more than 100% of the rated capacity. Please utilize this over capacity capability for load shedding or applications where it is known that all connected units will NOT be operating at the same time.

OUTDOOR UNIT ACCESSORIES: MXZ-SM60NAM-U1

Air Deflector	Vertical Air Deflector	ADV-1
Air Outlet Guide	Air Outlet Guide (1 Piece)	PAC-SH96SG-E (two pieces are required)
Ball Valve	Refrigeration Ball Valve - 1/2"	BV12FFSI2
	Refrigeration Ball Valve - 1/4"	BV14FFSI2
	Refrigeration Ball Valve - 3/8"	BV38FFSI2
	Refrigeration Ball Valve - 5/8"	BV58FFSI2
Branch Box	Branch Box	PAC-MKA32BC
	Branch Box	PAC-MKA52BC
	Branch Box Enclosure	BBE-1
Centralized Drain Pan	Central Drain Pan	PAC-SH97DP-E
Control Wire	M-Net Control Wire, 1,000' Roll (16-AWG, Standard, Twisted Pair, Shielded, Jacketed- Plenum rated)	CW162S-1000
	M-Net Control Wire, 250' Roll (16-AWG, Standard, Twisted Pair, Shielded, Jacketed- Plenum rated)	CW162S-250
Control/Service Tool	Maintenance Tool Interface	PAC-USCMS-MN-1
Distribution pipe	Brazed Connection	MSDD-50BR-E
	Flare Connection	MSDD-50AR-E
Drain Socket	Drain Socket	PAC-SH71DS-E
Hail Guards	Hail Guard	HG-A2
Mini-Split Wire	14 Gauge, 4 wire MiniSplit Cable—250 ft. roll	S144-250
	14 Gauge, 4 wire MiniSplit Cable—50 ft. roll	S144-50
	16 Gauge, 4 wire MiniSplit Cable—250 ft. roll	S164-250
	16 Gauge, 4 wire MiniSplit Cable—50 ft. roll	S164-50
Mounting Pad	Condensing Unit Mounting Pad: 24" x 42" x 3"	ULTRILITE2
	Outdoor Unit 3-1/4 inch Mounting Base (Pair) - Plastic	DSD-400P
Optional Defrost Heater	Optional Defrost Heater	PAC-SJ20BH-E
Port Adapter	Adaptor: 1/2" x 3/8"	MAC-A455JP-E
	Adaptor: 1/2" x 5/8"	MAC-A456JP-E
	Adaptor: 3/8" x 1/2"	MAC-A454JP-E
	Adaptor: 3/8" x 5/8"	PAC-SG76RJ-E
Stand	18" Dual Fan Stand	QSMS1802M
	24" Dual Fan Stand	QSMS2402M
	Condenser Wall Bracket	QSWB2000M-1
	Condenser Wall Bracket - Stainless Steel Finish	QSWBSS
	Outdoor Unit Stand — 12" High	QSMS1202M
Wind Baffle	Front Wind Baffle	WB-PA3 (two pieces are required)

MODEL: PAC-MKA30BC, PAC-MKA31BC, PAC-MKA32BC PAC-MKA50BC, PAC-MKA51BC, AND PAC-MKA52BC BRANCH BOX



Job Name:

System Reference:

Date:



PAC-MKA30BC
PAC-MKA31BC
PAC-MKA32BC



PAC-MKA50BC
PAC-MKA51BC
PAC-MKA52BC

DESCRIPTIONS

- The PAC-MKA32/52 have a thermal differential from set point of 1F regardless of which MXZ outdoor unit generation they are connected to.

SPECIFICATIONS

Model Name			PAC-MKA50BC PAC-MKA51BC PAC-MKA52BC	PAC-MKA30BC PAC-MKA31BC PAC-MKA32BC	
Connectable number of indoor units			Maximum 5	Maximum 3	
Power supply			Single phase, 208/230 V, 60 Hz		
Input	kW		0.003		
Running current	A		0.05		
External finish			Galvanized steel		
Dimensions	Width	Inch (mm)	17-23/32 (450)		
	Depth	Inch (mm)	11-1/32 (280)		
	Height	Inch (mm)	6-11/16 (170)		
Package Dimensions	Width	Inch (mm)	20.1 (511)		
	Depth	Inch (mm)	24.4 (620)		
	Height	Inch (mm)	8.3 (211)		
Weight		lb (kg)	23.4 (10.6)	21.8 (9.9)	
Piping Connection (Flare)	Branch (indoor side)*	Liquid	Inch (mm)	ø1/4 (6.35) x 5 {A,B,C,D,E}	
		Gas	Inch (mm)	ø3/8 (9.52) x 4 {A,B,C,D}, ø1/2 (12.7) x 1{E}	
	Main (outdoor side)	Liquid	Inch (mm)	ø3/8 (9.52)	
		Gas	Inch (mm)	ø5/8 (15.88)	

*The piping connection size differs according to the type of and capacity of indoor units. Match the piping connection size for indoor and branch box. If the piping connection size of the branch does not match the piping connection size of the indoor units, use optional different-diameter (deformed) joints to the branch box side. (Connect deformed joint directly to the branch box side.)

ACCESSORIES

BBE-1	Branch Box Enclosure
MAC-A454JP-E	Port Adapter
MAC-A455JP-E	Port Adapter
MAC-A456JP-E	Port Adapter
PAC-493PI	Port Adapter
PAC-SG76RJ-E	Port Adapter
ADP5834	Port Adapter
MSDD-50AR-D	Flare connection distribution pipe
MSDD-50BR-E	Brazed connection distribution pipe

NOTES:

For the MXZ-8C60 outdoor unit:

- When connecting the outdoor unit to the branch box directly, the reduction in pipe size must be made at the branch box using the port adaptor: ADP5834 (5/8" F x 3/4" M).
- When connecting the outdoor unit to the distribution pipe (MSDD-50AR-D, for using 2 branch boxes), the reduction in pipe size must be made at the distribution pipe using the port adaptor: ADP5834 (5/8" F x 3/4" M).

OPTIONAL PORT ADAPTORS

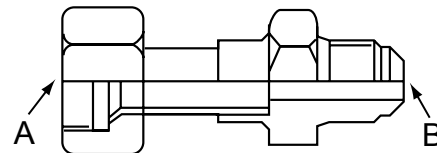

Model name	Connected pipes diameter	Diameter A	Diameter B
	Inch, mm	Inch, mm	Inch, mm
MAC-A454JP-E	3/8, ø9.52 → 1/2, ø12.7	3/8, ø9.52	1/2, ø12.7
MAC-A455JP-E	1/2, ø12.7 → 3/8, ø9.52	1/2, ø12.7	3/8, ø9.52
MAC-A456JP-E	1/2, ø12.7 → 5/8, ø15.88	1/2, ø12.7	5/8, ø15.88
PAC-493PI	1/4, ø6.35 → 3/8, ø9.52	1/4, ø6.35	3/8, ø9.52
PAC-SG76RJ-E	3/8, ø9.52 → 5/8, ø15.88	3/8, ø9.52	5/8, ø15.88
ADP5834	5/8, ø15.88 → 3/4, ø19.05	5/8, ø15.88	3/4, ø19.05

DIMENSIONS: PAC-MKA30BC, PAC-MKA31BC, AND PAC-MKA32BC

PAC-MKA30BC, PAC-MKA31BC, AND PAC-MKA32BC (3-BRANCHES TYPE)

Suspension bolt: W3/8 (M10)
Refrigerant pipe flared connection

inch, mm

	To indoor unit			To outdoor unit
	A	B	C	
Liquid pipe	1/4, ø6.35	1/4, ø6.35	1/4, ø6.35	3/8, ø9.52
Gas pipe	3/8, ø9.52	3/8, ø9.52	3/8, ø9.52	5/8, ø15.88

Conversion formula	
3/8F	ø9.52
5/8F	ø15.88

Unit: mm (inch)

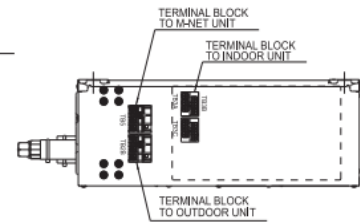
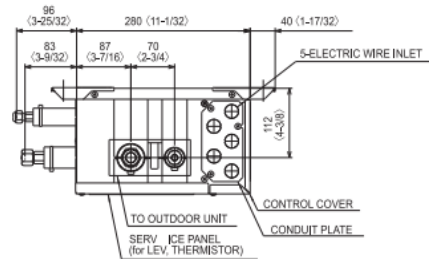
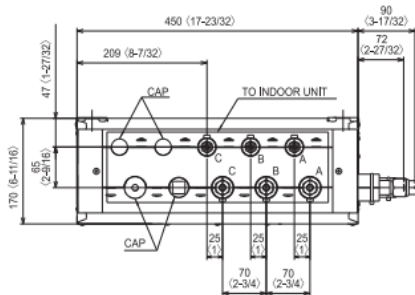
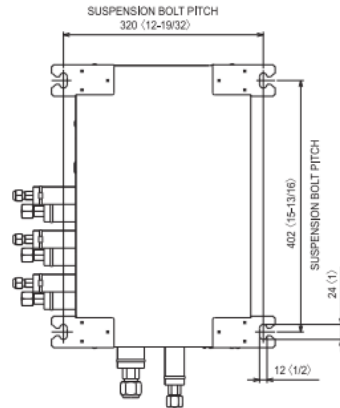

DIMENSIONS: PAC-MKA50BC, PAC-MKA51BC, AND PAC-MKA52BC

PAC-MKA50BC, PAC-MKA51BC, AND PAC-MKA52BC (5-BRANCHES TYPE)

Suspension bolt: W3/8 (M10)
Refrigerant pipe flared connection

inch, mm

	To indoor unit					To outdoor unit
	A	B	C	D	E	
Liquid pipe	1/4, ø6.35	1/4, ø6.35	1/4, ø6.35	1/4, ø6.35	1/4, ø6.35	3/8, ø9.52
Gas pipe	3/8, ø9.52	3/8, ø9.52	3/8, ø9.52	3/8, ø9.52	1/2, ø12.7	5/8, ø15.88

Conversion formula	
1/4F	ø6.35
3/8F	ø9.52
1/2F	ø12.7
5/8F	ø15.88
3/4F	ø19.05

Unit: mm (inch)

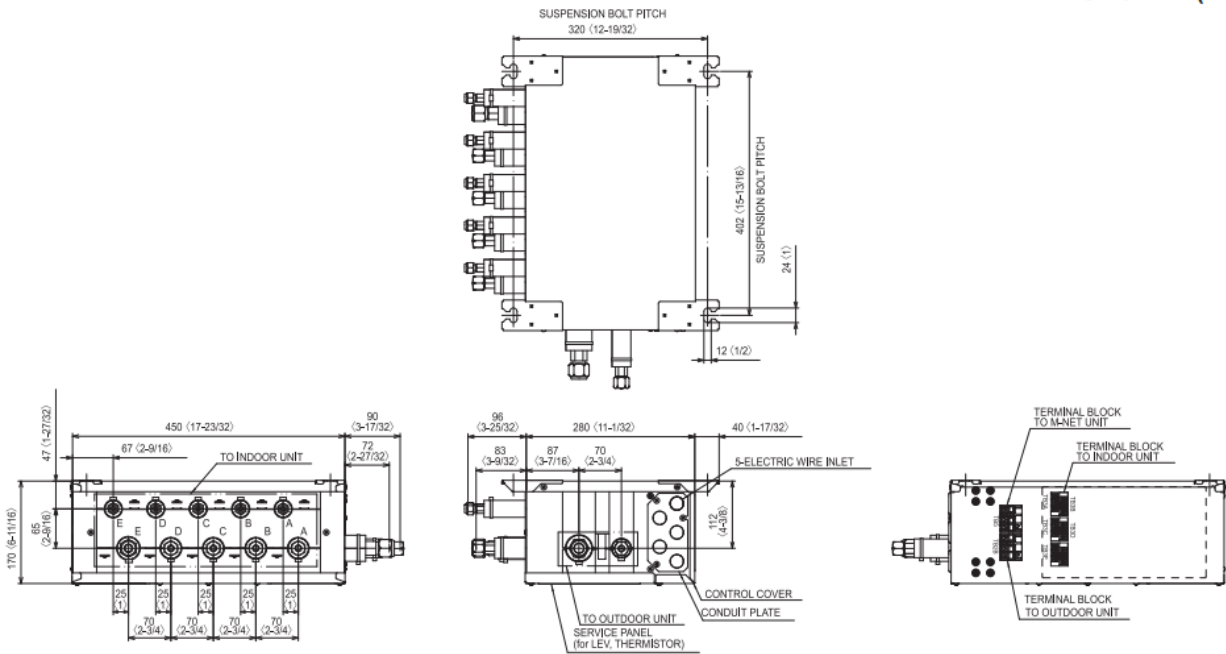

1340 Satellite Boulevard, Suwanee, GA 30024
Toll Free: 800-433-4822 www.mehvac.com

Job Name:	
System Reference:	Date:



Indoor Unit: MFZ-KJ09NA-U1



Wireless Remote Controller

SPECIFICATIONS:

Rated Capacity*		
Cooling ¹	Btu/h / W	9,000
Heating at 47° F ²	Btu/h / W	11,000

Rating Conditions per AHRI Standard:

¹ Cooling | Indoor: 80° F(27° C)DB / 67° F(19° C)WB ; Outdoor: 95° F(35° C)DB / 75° F(24° C)WB
² Heating at 47°F | Indoor: 70° F (21° C)DB / 60° F (16° C)WB ; Outdoor: 47° F (8° C)DB / 43° F (6° C)WB

For data on specific indoor units (all ducted, all non-ducted, and both ducted and non-ducted) combinations, see the MXZ Technical and Service Manual.

Applications should be restricted to comfort cooling only; equipment cooling applications are not recommended for low ambient temperature conditions.

Electrical Power Requirements	208 / 230V, 1-Phase, 60 Hz	
-------------------------------	----------------------------	--

Minimum Circuit Ampacity (MCA)	A	1.0
--------------------------------	---	-----

Blower Motor (ECM)	F.L.A.	0.62
--------------------	--------	------

Blower Motor Output	W	30
---------------------	---	----

Field Drainpipe Size O.D.	In.(mm)	5/8 (15)
---------------------------	---------	----------

Airflow Rate (Quiet - Lo - Med - Hi - Super Hi)			
Cooling	DRY	CFM	138-173-208-251-275
	WET		117-147-177-213-234
Heating	DRY		138-159-180-219-343

Sound Pressure Level (Quiet - Lo - Med - Hi - Super Hi)		
Cooling	dB(A)	21-25-30-34-38
Heating		21-24-27-32-41

Unit Dimensions (H x W x D)	In.(mm)	23-5/8 x 29-17/32 x 8-15/32 (600 x 750 x 215)
-----------------------------	---------	---

Package Dimensions (H x W x D)	In.(mm)	27-3/4 x 32-3/4 x 12 (693 x 816 x 275)
--------------------------------	---------	--

Unit/Package Weight		
Unit	Lbs.(kg)	33 (15)
Package	Lbs.(kg)	41 (18.5)

External Finish	Munsell 1.0Y 9.2 / 0.2	
-----------------	------------------------	--

Refrigerant Piping (Flared)		
Liquid (High Pressure)	In.(mm)	1/4 (6.35)
Gas (Low Pressure)		3/8 (9.52)

ACCESSORIES:

Indoor Unit

- Condensate Pump (BlueDiamond X87-711/721; 115/230V)
- Condensate Pump (Sauermann SI30-115/230; 115/230V)
- Anti-Allergy Enzyme Filter (MAC-408FT-E)
- Platinum Catalyst Deodorizing Filter (MAC-308FT-E)
- Drain Pan Level Sensor (DPLS2)

Controls

- Wireless Controller (MHK1)
- Wired Remote Controller PAR-32MAA (Requires MAC-333IF-E)
- Wireless Interface for kumo cloud™ (PAC-WHS01WF-E)
- Thermostat Interface (PAC-US444CN-1)

DIMENSIONS: MFZ-KJ09NA-U1

MFZ-KJ09NA-U1

Unit: in.

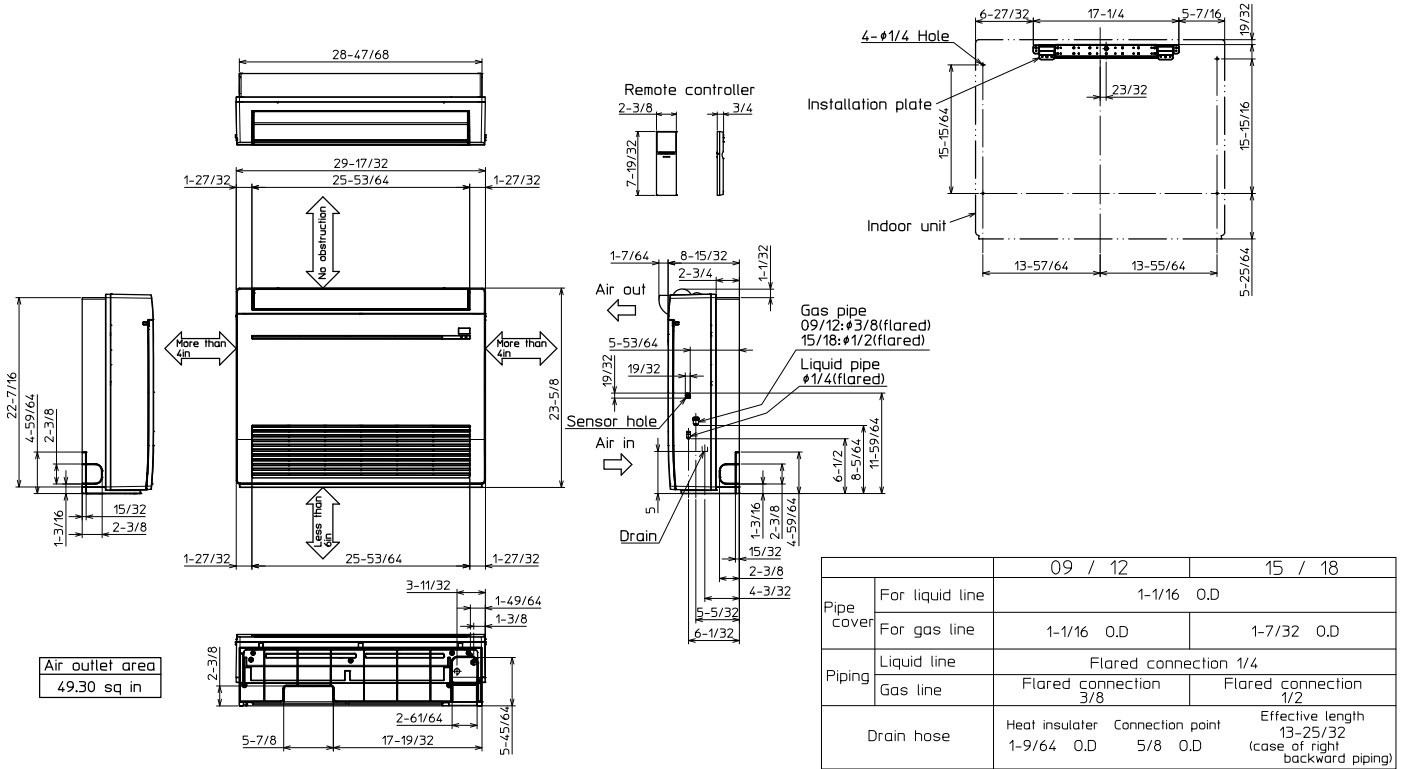

COOLING & HEATING

1340 Satellite Boulevard, Suwanee, GA 30024
 Toll Free: 800-433-4822 www.mehvac.com



Job Name:	
System Reference:	Date:



Indoor Unit: MFZ-KJ15NA-U1



Wireless Remote Controller

SPECIFICATIONS:

Rated Capacity*		
Cooling ¹	Btu/h / W	15,000
Heating at 47° F ²	Btu/h / W	18,000

Rating Conditions per AHRI Standard:

¹ Cooling | Indoor: 80° F(27° C)DB / 67° F(19° C)WB ; Outdoor: 95° F(35° C)DB / 75° F(24° C)WB
² Heating at 47°F | Indoor: 70° F (21° C)DB / 60° F (16° C)WB ; Outdoor: 47° F (8° C)DB / 43° F (6° C)WB

For data on specific indoor units (all ducted, all non-ducted, and both ducted and non-ducted) combinations, see the MXZ Technical and Service Manual.

Applications should be restricted to comfort cooling only; equipment cooling applications are not recommended for low ambient temperature conditions.

Electrical Power Requirements	208 / 230V, 1-Phase, 60 Hz	
-------------------------------	----------------------------	--

Minimum Circuit Ampacity (MCA)	A	1
--------------------------------	---	---

Blower Motor (ECM)	F.L.A.	0.62
--------------------	--------	------

Blower Motor Output	W	30
---------------------	---	----

Field Drainpipe Size O.D.	In.(mm)	5/8 (15)
---------------------------	---------	----------

Airflow Rate (Quiet - Lo - Med - Hi - Super Hi)

Cooling	DRY	CFM	198-237-282-328-374
	WET		168-201-240-279-318
Heating	DRY		212-254-290-325-470

Sound Pressure Level (Quiet - Lo - Med - Hi - Super Hi)

Cooling	dB(A)	28-31-36-40-43
Heating		29-34-36-39-49

Unit Dimensions (H x W x D)	In.(mm)	23-5/8 x 29-17/32 x 8-15/32 (600 x 750 x 215)
-----------------------------	---------	---

Package Dimensions (H x W x D)	In.(mm)	27-3/4 x 32-3/4 x 12 (693 x 816 x 275)
--------------------------------	---------	--

Unit/Package Weight

Unit	Lbs.(kg)	33 (15)
Package	Lbs.(kg)	41 (18.5)

External Finish	Munsell 1.0Y 9.2 / 0.2	
-----------------	------------------------	--

Refrigerant Piping (Flared)

Liquid (High Pressure)	In.(mm)	1/4 (6.35)
Gas (Low Pressure)		1/2 (12.7)

ACCESSORIES:

Indoor Unit

- Condensate Pump (BlueDiamond X87-711/721; 115/230V)
- Condensate Pump (Sauermann SI30-115/230; 115/230V)
- Anti-Allergy Enzyme Filter (MAC-408FT-E)
- Platinum Catalyst Deodorizing Filter (MAC-308FT-E)
- Drain Pan Level Sensor (DPLS2)

Controls

- Wireless Controller (MHK1)
- Wired Remote Controller PAR-32MAA (Requires MAC-333IF-E)
- Wireless Interface for kumo cloud™ (PAC-WHS01WF-E)
- Thermostat Interface (PAC-US444CN-1)

DIMENSIONS: MFZ-KJ15NA-U1

MFZ-KJ15NA-U1

Unit: in.

