



9,000 BTU/H WALL MOUNTED IDU

SUBMITTAL COVER SHEET

PROJECT NAME _____

LOCATION _____

ARCHITECT _____

ENGINEER _____

CONTRACTOR _____

REFERENCE _____

SUBMITTED BY _____ DATE _____

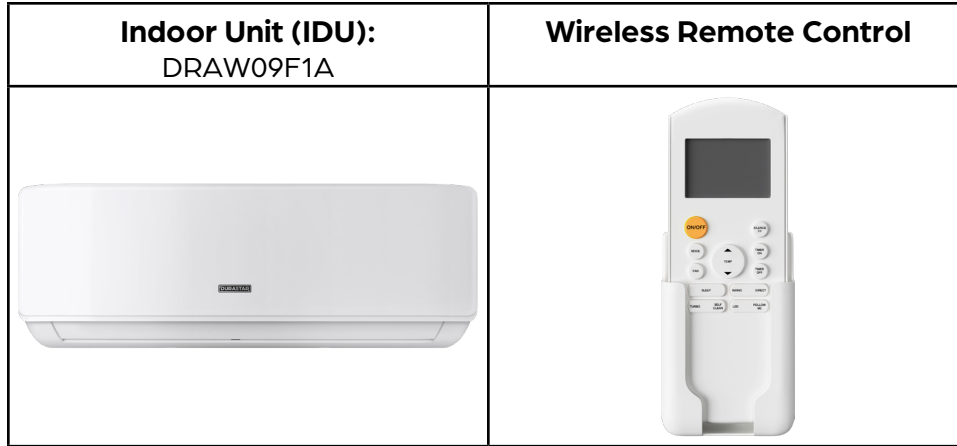

CAPACITIES		
Cooling Capacity (BTU/hr)	Rated	9000
Heating Capacity (BTU/hr)	Rated	9800

ELECTRICAL DATA	
Voltage/Phase/Frequency	208-230V, 1 Phase, 60 Hz

LINE SET REQUIREMENTS	
Connection Type	Flare
Liquid	Ø1/4" (Ø6.35mm)
Gas	Ø3/8" (Ø9.52mm)
Drain Port O.D. / Drain Hose I.D.	Ø5/8" (Ø16mm)

INDOOR UNIT FAN DATA		
Air Flow (CFM)	Low	141
	Medium	205
	High	265
Type	DC	
RLA	0.25	
Sound Pressure (dB(A))	Low	25
	Medium	30
	High	36.5

INDOOR UNIT DIMENSIONS		
Unit Dimensions	Width	31 9/16"
	Depth	7 7/16"
	Height	11 11/16"
Carton Dimensions	Width	34 7/16"
	Depth	11 1/4"
	Height	14 15/16"
Net Weight	18.5 lbs.	
Gross Weight	24.5 lbs.	

PRODUCT FEATURES

- Wireless Remote Control with "Follow Me" Technology
- Auto Restart
- Auto Changeover
- 24-hour Timer
- Self Clean Function





9,000 BTU/H WALL MOUNTED IDU

DIMENSIONS - DRAW09F1A

Unit Dimensions

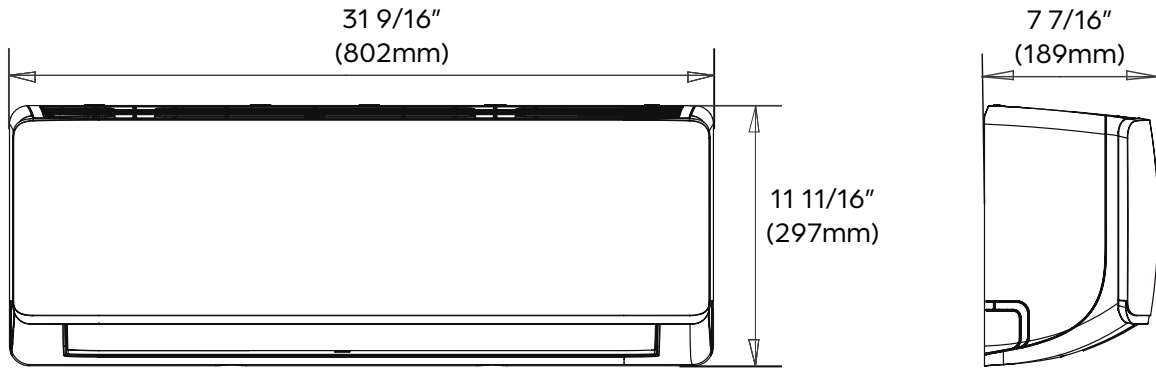

Mounting Plate Dimensions

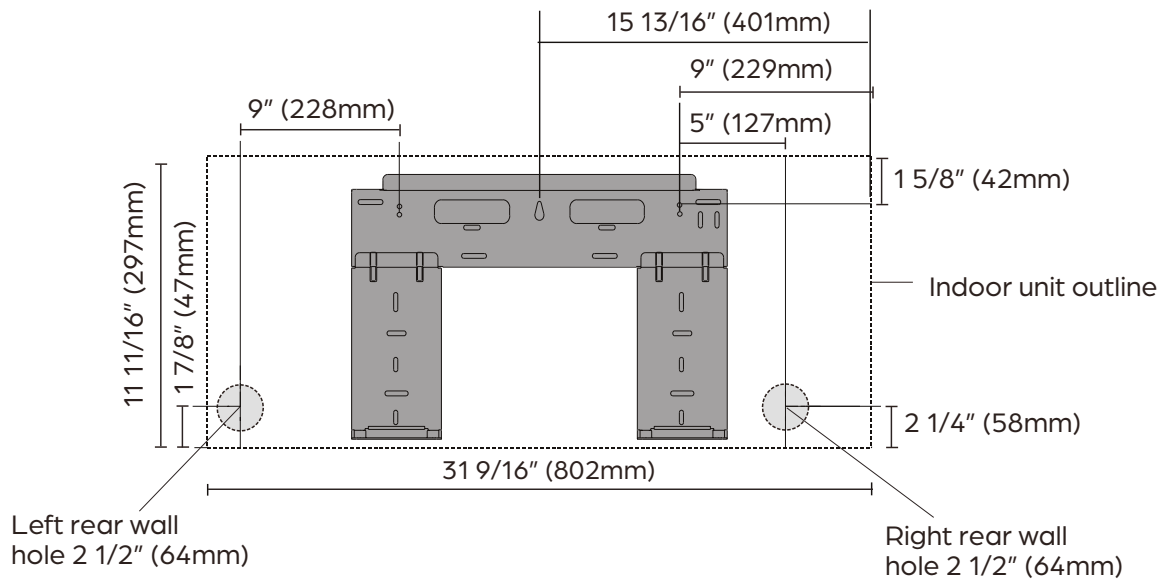

Clearance Distances

