

Programmable Thermostats

Detailed User Guide

2020 Single Stage Heat / Cool
Conventional and Heat Pump

2220 Up to 2 Heat / 2 Cool Conventional
Up to 2 Heat / 1 Cool Heat Pump

Model number is located on back of thermostat

- | | |
|-------------------------|---------------------------------|
| 1 Specifications | 6 Setting Your Program Schedule |
| 2 About Your Thermostat | 7 Operating Your Thermostat |
| 3 Installation | 8 Additional Operation Features |
| 4 System Testing | 9 Thermostat Maintenance |
| 5 Setting User Options | |



Warning *Turn off power to the heating or cooling equipment before installation.*



Attention *For installation by experienced service technicians only.*

Read all instructions before proceeding.

This thermostat requires 24 Volt AC Power or two (2) properly installed "AA" Alkaline batteries for proper operation. When connecting 24 Volt AC Power the batteries may be installed as a backup.

For use only as described in this manual. Any other use will void warranty.

1 Specifications

This thermostat is compatible with:

- Single stage heat / cool conventional and heat pump systems
- Conventional systems up to 2 heat / 2 cool (2220 only)
- Single compressor heat pump systems with an auxiliary heat stage (2220 only)
- 250 – 750 millivolt heat only systems

Electrical and control specifications:

- Electrical Rating: 24 Volt AC
- 1 amp maximum load per terminal
- AC Power: 18 – 30 Volts AC
- DC Power: 3.0 Volt DC (2 "AA" Alkaline Batteries Included)
- Control Range: 45° – 90° F (7° – 32° C)
- Temperature Accuracy: +/- 1° F (+/- .5° C)

Terminations

- 2020 – Rc, Rh, O, B, Y1, W1, G, C
- 2220 – Rc, Rh, O, B, Y1, Y2, E/W1, G, W2, C

2 About Your Thermostat

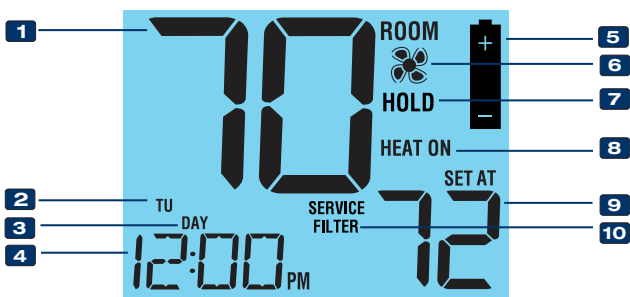

- 1 Room Temperature**Displays the current room temperature
- 2 Day of Week**.....Displays the current day of week
- 3 Program Event Indicator** ..Indicates the current program event
- 4 Time of Day**.....Displays the current time of day
- 5 Low Battery Indicator**Indicates when batteries need to be replaced
- 6 Fan Indicator**Indicates when the system fan is running
- 7 Hold Mode Indicator**.....Displays if in HOLD mode
- 8 System Status Indicator**...Displays information about system status
- 9 Set Temperature**Displays the current set point temperature
- 10 Service Filter Indicator**.....Displays service/maintenance reminders

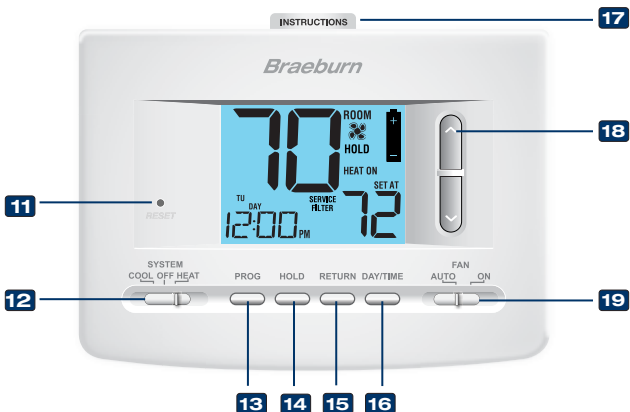

- 11 Reset Button** Resets thermostat back to factory defaults
 - 12 System Switch**..... Selects system preference
 - 13 PROG Button** Selects programming mode
 - 14 HOLD Button** Enters/Exits the HOLD mode (program bypass)
 - 15 RETURN** Returns to normal from program or setting modes
 - 16 DAY/TIME Button** ...Used to set the time and day of week
 - 17 Quick Reference Instructions** Stored in slot at top of thermostat
 - 18 Arrow Buttons** Used to increase or decrease settings
 - 19 Fan Switch**..... Selects the system fan mode
- Battery Compartment**Located in back of the thermostat

3 Installation

 **Warning** *Disconnect power before beginning installation.*

Thermostat Location

Install the thermostat approximately 5 feet (1.5m) above the floor in an area that has a good amount of air circulation and maintains an average room temperature.

Avoid installation in locations where the thermostat can be affected by drafts, dead air spots, hot or cold air ducts, sunlight, appliances, concealed pipes, chimneys and outside walls.

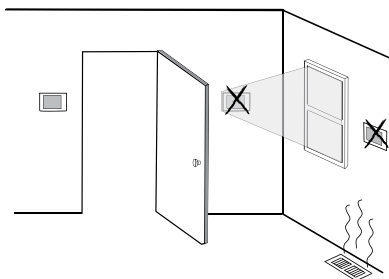

Install your new Braeburn thermostat in 5 basic steps:

- 1 Install the Sub-Base
- 2 Provide Power
- 3 Connect Your Wires
- 4 Set Installer Switches
- 5 Attach Thermostat to Sub-Base

1 Install the Sub-Base:

- Remove the sub-base from the body of the thermostat.
- Mount the sub-base as shown below:

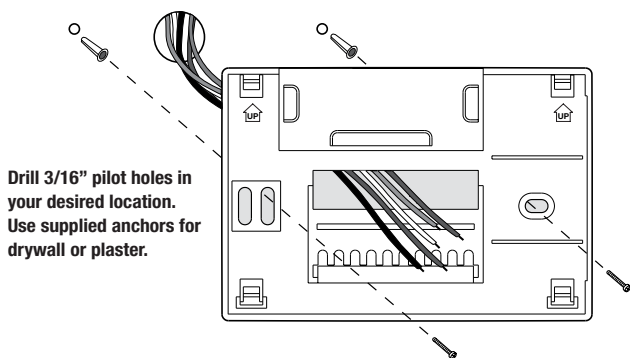

NOTE: After sub-base installation, you may insert the quick reference card into the slot on the top of the base.

2 Provide Power

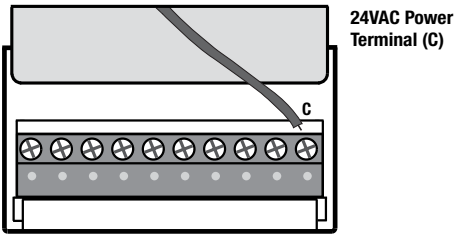

- For **24 Volt AC power**, you must connect the common side of the transformer to the C terminal on the thermostat sub-base.
- For **primary or back-up power**, insert the 2 supplied “AA” type alkaline batteries into the battery compartment located in the rear housing of the thermostat. Make sure to position the Positive (+) and Negative (-) sides of the batteries correctly with the +/- symbols in the battery compartment.

3 Connect Your Wires

Wiring Terminations

Terminal	Function	Description
Rc	Input	24 Volt AC Cooling Transformer (Dual Transformer Systems Only)
Rh	Input	Power Connection (24 Volt AC Heating Transformer or Millivolt Power Source)
O	Output	Reversing Valve (Cool Active)
B	Output	Reversing Valve (Heat Active)
Y1	Output	Compressor Relay
G	Output	Fan Control
W1	Output	Conventional Heat Relay
C	Input	24 Volt AC Transformer Common

Additional Terminations (2220 only)

Terminal	Function	Description
W1/E	Output	(W1) 1st Stage Conventional Heat (E) Emergency Heat Relay
Y2	Output	2nd Stage Conventional Cooling Compressor
W2	Output	2nd Stage Heat / Auxiliary Heat

Conventional Systems

Typical Wiring Configurations

NOTE: The “Installer Switch” option will be configured in the next step.

Heat Only or Millivolt

Set Installer Switch to **CONV**

Rh	Power Connection
W	Heat Relay (appears as W1/E on 2220)
G	Fan Relay [note 4]
C	24 Volt AC Transformer Common [note 1]

1 HEAT / 1 COOL Single or Dual Transformer

Set Installer Switch to **CONV**

Rh	24 Volt AC Power (heating transformer) [note 2]
Rc	24 Volt AC Power (cooling transformer) [note 2]
W1	Heat Relay (appears as W1/E on 2220)
Y1	Compressor Relay
G	Fan Relay
C	24 Volt AC Transformer Common [note 1, 3]

2 HEAT / 2 COOL Single or Dual Transformer (2220 Only)

Set System Type to **CONV**

Rh	24 Volt AC Power (heating transformer) [note 2]
Rc	24 Volt AC Power (cooling transformer) [note 2]
W1	Heat Relay Stage 1
W2	Heat Relay Stage 2
Y1	Compressor Relay Stage 1
Y2	Compressor Relay Stage 2 [note 4]
G	Fan Relay
C	24 Volt AC Transformer Common [note 1, 3]

NOTES - Conventional Systems

- [1]** If batteries are installed the 24 Volt AC common connection is optional
- [2]** Remove factory installed jumper for dual transformer systems
- [3]** In dual transformer systems, transformer common must come from cooling transformer
- [4]** If needed for system

Provide disconnect and overload protection as required.

Heat Pump Systems

Typical Wiring Configurations

NOTE: The “Installer Switch” option will be configured in the next step.

1 HEAT / 1 COOL - No Auxiliary Heat

Set Installer Switch to **HP**

Rh	24 Volt AC Power
Rc	Connected to Rh with supplied Jumper Wire
O or B	Changeover Valve [note 2]
Y1	Compressor Relay
G	Fan Relay
C	24 Volt AC Transformer Common [note 1]

2 HEAT / 1 COOL - Including Auxiliary Heat (2220 only)

Set Installer Switch to **HP**

Rh	24 Volt AC Power
Rc	Connected to Rh with supplied Jumper Wire
O or B	Changeover Valve [note 2]
Y1	Compressor Relay (1st stage heating/cooling)
W2	Auxiliary Heat Relay (2nd stage heating) [note 3]
E	Emergency Heat Relay [note 3]
G	Fan Relay
C	24 Volt AC Transformer Common [note1]

NOTES - Heat Pump Systems

[1] If batteries are installed the 24 Volt AC common connection is optional.

[2] Select **O** for cool active or **B** for heat active.

[3] Install a field supplied jumper between the **W2** and **E** terminals if there is no separate emergency heat relay installed.

Provide disconnect and overload protection as required.

4 Set Installer Switches

The Installer switches are located on the back of the thermostat and must be properly configured for this thermostat to operate properly.

Switch	Factory Default	Setting Options	Comments
CONV / HP	CONV	CONV	Select for conventional systems
		HP	Select for heat pump systems
F / C	F	F	Select for fahrenheit temperature scale
		C	Select for celsius temperature scale
HE / HG	HG	HG	Select for gas heat
		HE	Select for electric heat

NOTE: Installer switches are located on the back of the thermostat. The reset button must be pressed after making any changes to these switches.

5 Attach Thermostat to Sub-Base

1. Line up the thermostat body with the sub-base.
2. Carefully push the thermostat body against the sub-base until it snaps into place.
3. Insert quick reference card into slot on top of thermostat.

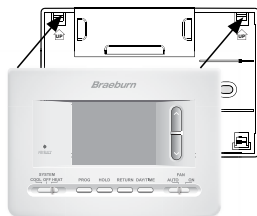

4 System Testing

Warning Read Before Testing

- Do not short (or jumper) across terminals on the gas valve or at the heating or cooling system control board to test the thermostat installation. This could damage the thermostat and void the warranty.
- Do not select the COOL mode of operation if the outside temperature is below 50° F (10° C). This could possibly damage the controlled cooling system and may cause personal injury.
- This thermostat includes an automatic compressor protection feature to avoid potential damage to the compressor from short cycling. When testing the system, make sure to take this delay into account.

NOTE: The compressor delay can be bypassed by pressing the reset button on the front of the thermostat. All user settings will be returned to factory default.

- 1 Move the **SYSTEM** switch to HEAT mode.
- 2 Press **▲** to raise the set temperature a minimum of 3 degrees above the current room temperature. The system should start within a few seconds. With a gas heating system, the fan may not start right away.
- 3 Move the **SYSTEM** switch to the OFF mode. Allow the heating system to fully shut down.
- 4 Move the **SYSTEM** switch to the COOL mode.
- 5 Press **▼** to lower the set temperature a minimum of 3 degrees below the current room temperature. The system should start within a few seconds (unless compressor short cycle protection is active – See note above).
- 6 Move the **SYSTEM** switch to the OFF mode. Allow the cooling system to fully shut down.
- 7 Move the **FAN** switch to the ON mode. The system fan should start within a few seconds.
- 8 Move the **FAN** switch to the AUTO mode. Allow the system fan to turn off.

5 Setting User Options

Advanced User Options

User options allow you to customize some of your thermostat's features. Most users will not need to make any changes to the settings in this section.

To enter the User Options menu, hold down the RETURN button for approximately 3 seconds until the screen changes and displays the first User Option.

Press the **▲** or **▼** button to change the setting for the displayed User Option. After you have made your desired setting, press **RETURN** to advance to the next User Option.

The thermostat will return to normal mode after your last user option is made or after no keys have been pressed for 15 seconds.

Table of User Options

No.	User Options	Factory Default	Setting Options	Comments
1	1st stage differential	0.5	0.5, 1.0 OR 2.0	Select a 1st stage temperature differential of .5°, 1° or 2°F (.2°, .5° or 1°C)
2	2nd stage differential (2220 Only)	2.0	1.0, 2.0, 3.0, 4.0, 5.0 OR 6.0	Select a 2nd temperature differential of 1°, 2°, 3°, 4°, 5° or 6°F (.5°, 1°, 1.5°, 2°, 2.5° or 3°C)
3	Extended Hold Period	LNG	LNG	Selects long (permanent) hold mode
			24HRS	Selects 24 hr. (temporary) hold mode
4	Filter Service Monitor	OFF	OFF	Disables filter service monitor feature
			30, 60, 90, 120, 180, 365	Selects a number of days before the thermostat will flash a Service Filter reminder in the display.
5	Adaptive Recovery Mode(ARM™)	OFF REC	OFF REC	Disables adaptive (early) recovery mode
			ON REC	Enables adaptive (early) recovery mode

Detailed Explanation of User Options:

Temperature Differential

(User Option 1 and 2)

The differential setting is the temperature control range that your thermostat will provide. The smaller the setting, the tighter your range of temperature control and comfort will be. The 2nd stage differential is only for systems with a second stage of heating (auxiliary heat).

Extended Hold Period

(User Option 3)

The Extended Hold Period lets you select the period your thermostat will hold the temperature when the HOLD mode is activated (See “Temperature Adjustment”). When LNG is selected the thermostat will hold your temperature indefinitely. When 24HR is selected, the thermostat will hold your temperature for 24 hours and then return to the current program at that time.

Service Filter Monitor

(User Option 4)

The Service Filter Monitor is a user selectable service monitor that will display a reminder for a required air filter replacement by flashing the SERVICE FILTER segment in the display. When the selected interval has been reached, and required cleaning or replacement has been performed, touch the **RETURN** button to reset the timer and reset the service monitor. Select OFF or a set number of days before the reminder will appear.

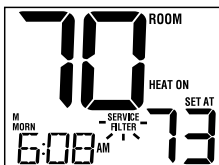

Adaptive Recovery Mode (early recovery)

(User Option 5)

During Adaptive Recovery Mode (ARM™), room temperature is recovered gradually by turning on the heating or cooling before the end of the set back period. The set point temperature is changed to that of the upcoming program temperature.

6 Setting Your Program Schedule

Setting the Time and Day

1. In normal operating mode, press the **DAY/TIME** button. The display will switch to the day/time setting mode and the hour will be flashing.
2. Press **▲** or **▼** to adjust the hour. Press **DAY/TIME**.
3. Press **▲** or **▼** to adjust the minute. Press **DAY/TIME**.
4. Press **▲** or **▼** to adjust the day of the week. Press **RETURN** to exit.

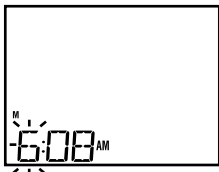

Tips Before Setting Your Program Schedule

- Make sure your current time and day of the week are set correctly.
- When programming, make sure the AM and PM indicators are correct.

This thermostat comes pre-programmed with a default energy saving program. The following table outlines the pre-programmed times and temperatures for heating and cooling in each of your 4 daily weekday and weekend events. If you wish to use these settings then no further programming is necessary:

5-2 Day Programming– Weekday/Weekend <i>Factory Settings</i>		
4 Event	Weekday	Weekend
MORN	Time: 6:00 am Heat: 70° F (21° C) Cool: 75° F (24° C)	Time: 6:00 am Heat: 70° F (21° C) Cool: 75° F (24° C)
DAY	Time: 8:00 am Heat: 62° F (17° C) Cool: 83° F (28° C)	Time: 8:00 am Heat: 70° F (21° C) Cool: 75° F (24° C)
EVE	Time: 6:00 pm Heat: 70° F (21° C) Cool: 75° F (24° C)	Time: 6:00 pm Heat: 70° F (21° C) Cool: 75° F (24° C)
NIGHT	Time: 10:00 pm Heat: 62° F (17° C) Cool: 78° F (26° C)	Time: 10:00 pm Heat: 62° F (17° C) Cool: 78° F (26° C)

Programming a 5-2 Day Residential Schedule

The 5-2 day residential programming mode allows you to program Monday - Friday with one 4 event schedule and then allows you to change Saturday and Sunday with a different 4 event schedule.

1. Touch the **PROG** button. The display will switch to programming mode. The days M, TU, W, TH, and F will be displayed and the hour will be flashing.
2. Move the **SYSTEM** switch to either the HEAT or COOL position.
3. Press the **▲** or **▼** to adjust the hour for the MORN (morning) event. Press **PROG**.
4. Press **▲** or **▼** to adjust the minute for the MORN event. Press **PROG**.
5. Press **▲** or **▼** to adjust the temperature for the MORN event. Press **PROG**.
6. Repeat steps 3-5 for the DAY, EVE and NIGHT events.
7. Repeat steps 3-6 for the weekend (S, SU) program.
8. If needed, repeat steps 2-7 to program the opposite mode (HEAT or COOL).
9. Press **RETURN** to exit.

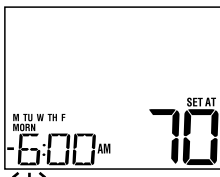

7 Operating Your Thermostat

Setting the System Control Mode

The System Control has several modes of operation that can be selected by moving the SYSTEM switch to the appropriate position.

COOL Only your cooling system will operate

OFF Heating and cooling systems are off

HEAT Only your heating system will operate



Additional Switch Position (Model 2220 Only):

EMER Operates a backup heat source (Emergency Heat) for heat pump systems only

NOTE: If your model 2220 was configured for a conventional system (CONV) then you will not have the EMER (emergency heat) option and "NO EMER SET" will flash in the display if EMER is selected with the system switch.

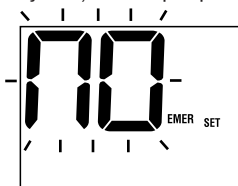

Setting the Fan Control Mode

The Fan Control has 2 modes of operation – AUTO and ON. The mode can be selected by moving the FAN switch to the appropriate position.

AUTO The system fan will run only when your heating or cooling system is running

ON The system fan stays on



Temperature Adjustment

Temporary Adjustment – Press the **▲** or **▼** button to adjust the current set point temperature.

Extended Adjustment – Press the **HOLD** button so that HOLD appears in the display screen. Press **▲** or **▼** to adjust the current set temperature (See "Extended Hold Period", page 8).

Status Indicators

Status indicators appear in the display to let you know if your system is heating, cooling or off.

HEAT ON Indicates that your heating system is running.

COOL ON Indicates that your cooling system is running.

SERVICE Indicates that a user selectable service reminder was selected (see “Service Filter Monitor, page 8).

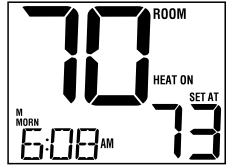

Additional status indicators (Model 2220 Only):

AUX Indicates that the auxiliary stage of heating is running (multi-stage systems only).

EMER Indicates that the emergency heating system is running (heat pump systems only).

Program Event Indicators

Program Event Indicators appear in the display to let you know what part of your current program is active. The 4 different program event indicators are MORN, DAY, EVE and NIGHT.

When the program event indicator is flashing, your program has been temporarily bypassed and will resume at the next scheduled event.

Note: You will not see a program event indicator while in HOLD Mode.

Resetting the Thermostat

This thermostat provides you with a reset button that will erase all of your user settings and 5-2 day programming.

To reset the thermostat, use a small object such as a tooth pick or paperclip and gently press the button located inside the small hole on the front of the thermostat housing labeled “reset”.

8 Additional Operation Features

Compressor Protection

This thermostat includes an automatic compressor protection delay to avoid potential damage to your system from short cycling. This feature activates a short delay after turning off the system compressor.

9 Thermostat Maintenance

Changing the Batteries

Depending on your particular installation, this thermostat may be equipped with two (2) "AA" type alkaline batteries.

If batteries are installed and they become low, a low battery indicator will appear in the display. You should change your batteries immediately when you see the low battery signal by following these instructions.

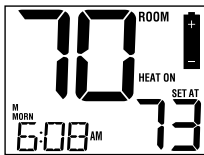

1. Remove thermostat body by gently pulling it from base.
2. Remove old batteries and replace with new batteries.
3. Make sure to correctly position the (+) and (-) symbols.
4. Gently push thermostat body back onto base.

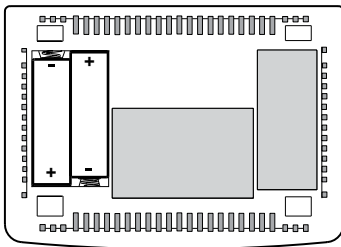

NOTE: We recommend replacing the thermostat batteries annually or if the thermostat will be unattended for an extended period of time.

Thermostat Cleaning

Never spray any liquid directly on the thermostat. Using a soft damp cloth wipe the outer body of the thermostat. Never use any abrasive cleansers to clean your thermostat.

Store this manual for future reference

Limited Warranty

When installed by a professional contractor, this product is backed by a 5 year limited warranty. Limitations apply. For limitations, terms and conditions, you may obtain a full copy of this warranty:

- Visit us online: www.braeburnonline.com/warranty
- Phone us: 866.268.5599
- Write us: Braeburn Systems LLC
2215 Cornell Avenue
Montgomery, IL 60538



Braeburn Systems LLC
2215 Cornell Avenue • Montgomery, IL 60538
Technical Assistance: www.braeburnonline.com
Call us toll-free: 866-268-5599 (U.S.)
630-844-1968 (Outside the U.S.)