



SINK FAUCET

Z842B6-XL

TAG _____



Engineering Specifications: Zurn AquaSpec® Z842B6-XL

Polished chrome-plated cast brass 8" [203mm] sink faucet with quarter turn ceramic disc cartridges, 3/8" [10mm] short swivel inlets providing adjustable centers from 7-1/4" [184mm] to 8-3/4" [222mm] and a 5-3/8" [137mm] centerline rigid or swing gooseneck spout with a 2.2 GPM [8.3 L] pressure compensating aerator (complying with ANSI A112.18.1 Standard for flow). Unit is furnished with 6" [152mm] vandal-resistant color-coded metal wrist blade handles.

Zurn Lead Free products (-XL), is the line of durable, high quality brass faucets and fixtures that are designed and manufactured to comply with state laws and local codes that mandate lead content levels. Zurn Lead Free products (-XL) are manufactured with less than one quarter of one percent (0.25%) total lead content by weighted average.

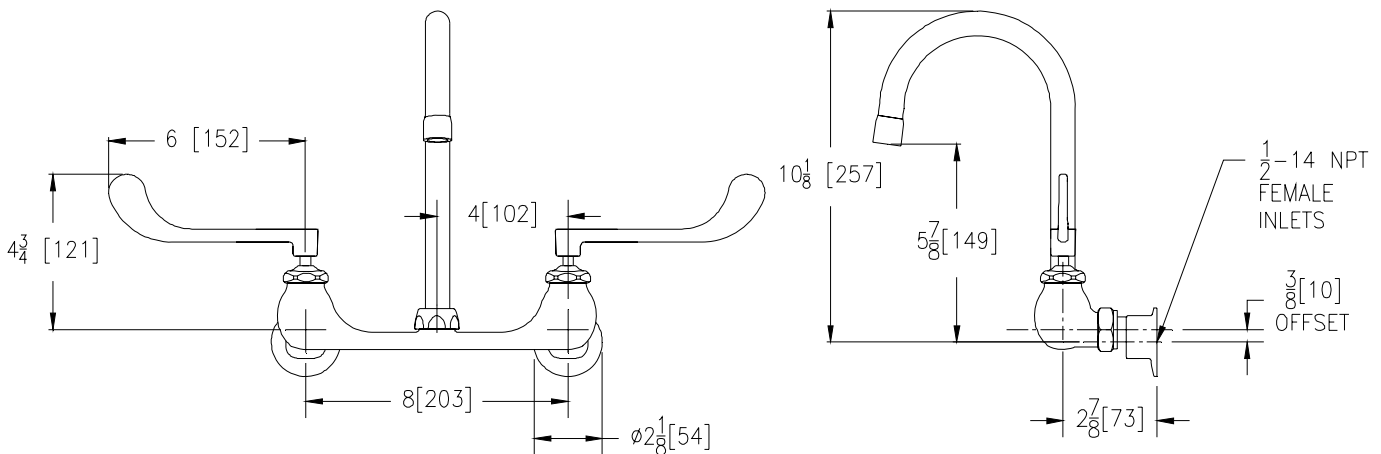

Note: All dimensions are for reference only. Do not use for pre-plumbing



OPTIONAL ACCESSORIES

Suffix	Description
___ -HCT	Hot/Cold Text Indexes
___ -LSI	2-1/2" [64mm] Long Swivel Inlets with Integral Stops
___ -2F	2.2 GPM [8.3 L] Vandal-Resistant Pressure Compensating Female Aerator
___ -3F	0.5 GPM [1.9 L] Vandal-Resistant Pressure Compensating Female Spray Outlet
___ -4F	2.2 GPM [8.3 L] Vandal-Resistant Pressure Compensating Female Laminar Flow Outlet
___ -7F	1.0 GPM [3.8 L] Pressure Compensating Female Spray Outlet
___ -16F	1.0 GPM [3.8 L] Vandal Resistant Pressure Compensating Female Spray Outlet
___ -17F	1.5 GPM [5.7 L] Vandal Resistant Pressure Compensating Female Aerator
___ -18F	1.5 GPM [5.7 L] Vandal Resistant Pressure Compensating Female Laminar Flow

ZURN INDUSTRIES, LLC ♦ COMMERCIAL BRASS OPERATION ♦ 2640 SOUTH WORK STREET ♦ FALCONER NY 14733

Phone: 1-716-665-1132 ♦ Fax: 1-716-665-1135 ♦ World Wide Web: www.zurn.com

In Canada: ZURN INDUSTRIES LIMITED ♦ 3544 Nashua Drive ♦ Mississauga, Ontario L4V1L2 ♦ Phone: 905/405-8272 Fax: 905/405-1292