

# ZLINE

ATTAINABLE LUXURY®

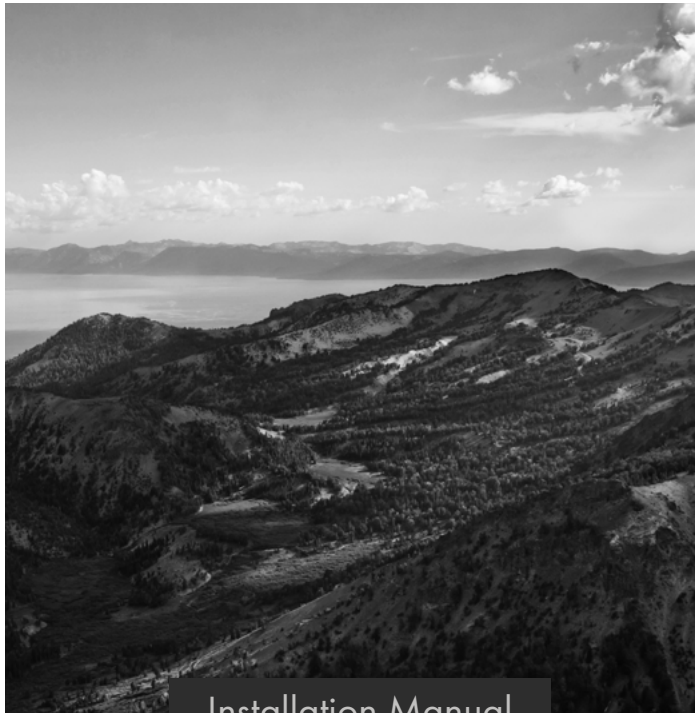

Installation Manual

## MONUMENT WINE & BEVERAGE COOLERS

[www.zlinekitchen.com](http://www.zlinekitchen.com)



ZLINE Kitchen and Bath provides Attainable Luxury, where the kitchen and bath of your dreams is never out of reach. Through our unique designs and unparalleled quality, we're dedicated to providing you an elevated experience in the heart of your home. With an endless selection of features and finishes, our inspiration is your reality.

**ZLINE**  
ATTAINABLE LUXURY®



ZLINE is fueled by a passion for innovation; A relentless pursuit of bringing the highest end luxury designs and professional features into everyone's homes.

Because we continually strive to improve our products, we may change specifications and designs without prior notice.

**Scan the QR code to view the most up-to-date version of the Installation Manual and User Manual.**

**⚠ WARNING:** This product can expose you to chemicals including nickel, which is known to the State of California to cause cancer. For more information, go to [www.P65Warnings.ca.gov](http://www.P65Warnings.ca.gov).

# TABLE OF CONTENTS

IMPORTANT SAFETY INSTRUCTIONS..... 1

BEFORE INSTALLATION..... 8

INSTALLATION ..... 12

WARRANTY..... 17



# IMPORTANT SAFETY INSTRUCTIONS



If the information in this manual is not followed exactly, a fire or explosion may result causing property damage, personal injury, or death.

- Before beginning installation, please read and follow these important instructions for the safety of your home and the people living in it. Always read and obey all safety measures.
- It is recommended that installation and service be performed by a qualified installer. The appliance should not be adjusted or repaired by anyone except properly qualified service personnel.
- **IMPORTANT:** The installer should leave these instructions with the consumer who should retain for local inspectors' use and for future reference.
- The manufacturer will not be responsible for any damage to property or to persons caused by incorrect installation, improper use of the appliance, or failure to heed the warnings listed, and the warranty will be voided.
- The manufacturer reserves the right to make changes to its products when considered necessary and useful, without affecting the essential safety and operating characteristics.
- This appliance has been designed for non-commercial, domestic use only.
- Please observe all local, state, and national codes and ordinances. Please ensure the appliance is properly grounded. The plug should always be accessible.
- Use this appliance only as described in this manual. Other uses not recommended may cause fire, electric shock, or personal injury.
- This appliance is not intended for use by children unless they are adequately supervised by a responsible person to ensure that they can use the appliance safely.
- Young children should be supervised to ensure that they never play with the appliance.
- To protect against the risk of electric shock, never immerse the unit, cord, or plug in water or spray with any cleaning product or other liquid.

# IMPORTANT SAFETY INSTRUCTIONS

- Unplug the appliance from the electrical outlet when not in use, when moving from one location to another, and before cleaning.
- To disconnect the appliance from power, grip the plug and pull it from the electrical outlet. Never pull by the cord.
- Never operate the unit in the presence of explosive and/or flammable liquids or fumes; doing so may create a fire hazard or explosion.
- Never install the unit or any of its parts near an open-flame, cooking, microwave, or any other heating appliance.
- Never operate the unit with a damaged electrical cord or plug, if the product malfunctions beyond simple troubleshooting measures, or if it is dropped or damaged in any manner.
- The use of attachments not recommended by the manufacturer may be hazardous to your safety.
- Never operate the unit if the door or cooling system is removed or damaged.
- A loose fit between the electrical wall outlet and plug may cause overheating and/or a distortion of the plug. Contact a qualified electrician to replace loose or worn electrical outlets.
- This appliance is CFC- and HFC-free and contains small quantities of isobutane (R600a), an environmentally friendly coolant.
- You must ensure that the sealed cooling system is undamaged when installing the appliance. If damaged, keep the product away from potential fire sources that may cause it to catch fire and ventilate the room where the product is placed.
- Never use an appliance with a damaged cooling system. If system is damaged upon arrival, contact ZLINE at 1-614-777-5004
- Ensure that the ventilation openings to and from a built-in wine cooler or beverage fridge are never blocked or covered.
- No liability will be accepted for any damage caused by misuse of the appliance, or as a result of repairs carried out by unqualified people. In this case, neither the warranty nor any other liability claims will apply.

# IMPORTANT SAFETY INSTRUCTIONS



Never operate any other electrical appliance inside this unit.

- Never attempt to repair or replace any part of your appliance unless it is specifically recommended in this manual. All other servicing should be referred to a qualified electrician, technician, or service provider.
- Ensure all access panels are appropriately installed before operating.
- It's recommended to use two or more people to move and install the unit due to its weight.
- Never clean the unit or its parts with flammable liquids. These fumes can create a fire hazard or explosion.
- Never connect or disconnect the electric plug with wet hands.
- It's recommended that a dedicated electrical circuit suitable for a NEMA 5-15 outlet serving only your appliance be used; please ensure the outlet is easily accessible.



To reduce the risk of fire, electric shock or personal injury, unplug or disconnect the appliance from the power supply before servicing.

# IMPORTANT SAFETY INSTRUCTIONS

## SAVE THESE INSTRUCTIONS

This manual contains important information regarding the proper installation, use, and maintenance of your beverage fridge and wine cooler. Following this manual will ensure that your product will work at its peak performance and efficiency.

If you are experiencing problems, check the “Troubleshooting” section of the User Manual.

## DISPOSAL OF REFRIGERATION APPLIANCES

Dispose of your appliance packaging properly. Refrigeration equipment must be properly disposed of in an environmentally-friendly manner. This applies to any old appliances and to your new unit once it reaches the end of its service life.



Please ensure that old or worn appliances are rendered unusable before disposal by removing the plug, cutting the power cable, and removing or destroying any snap fastenings or bolts. This will prevent children from locking themselves in the appliance (risk of suffocation) and endangering their lives in any other way.



Risk of child entrapment. To avoid safety and suffocation risks for children or pets, before you dispose of the appliance, take off the doors and drawers and leave the shelves in place so children or pets may not climb inside.

The cooling system, particularly the heat exchange located at the back/bottom of the unit, must not be damaged during installation or when using the appliance.

- This product is not to be handled as normal household waste — it should be taken to a recycling collection point for electrical and electronic goods.
- By correctly disposing of this product you are contributing to the protection of the environment. Improper disposal endangers health and the environment.
- Further information about the proper recycling of the product may be obtained from your local government agency or waste collection department.



# IMPORTANT SAFETY INSTRUCTIONS

## BEFORE USING YOUR APPLIANCE

- Remove all exterior and interior packing materials.
- Before connecting the appliance to the electrical source, let it sit upright for approximately 2 hours. This will reduce the possibility of malfunctions in the cooling system caused by handling during shipping.
- Prior to use, clean the interior surface with warm water using a soft cloth.
- The door on this appliance is designed so it may be opened from either the left or the right side. The unit is delivered with the door opening on the left side and swinging out to the right. Should you wish to open the door from the right, see installation instructions on page 15.

## INSTALLATION OF YOUR APPLIANCE



**Do not store or install the appliance outdoors.**

- Wine coolers and beverage fridges are designed for either built-in or free-standing installation.
- Place your unit on a floor that is strong enough to support it when it is fully loaded. Please note the units weigh roughly 136 to 144 pounds (62 to 65 kilograms) when empty, so adjust accordingly.
- To level your appliance, adjust the 4 legs by twisting clockwise or counter-clockwise as needed until level.
- Install the appliance indoors and away from direct sunlight and sources of heat (stove, heater, radiator, etc.). Sunlight may affect the acrylic coating, and heat sources may increase electrical consumption. Extreme cold ambient temperatures may also cause the unit not to perform properly.
- Never install the unit in damp or overly humid areas.
- Any questions concerning power and/or electrical connection should be directed toward a qualified electrician, technician, or service provider.
- The air vent located at the bottom front of the appliance must never be covered or blocked in any way.

# IMPORTANT SAFETY INSTRUCTIONS

- The unit must be appropriately installed to all electrical connections in accordance with state and local government codes.
- Please note that the cooler may experience decreased cooling efficiency if air flow is restricted due to a fully loaded cabinet.
- Install the wine cooler or beverage fridge in a well-ventilated area where the ambient temperature is above 50 °F and below 90 °F (above 10 °C and below 32 °C).

## ATTENTION

- Never overload the unit's cabinet.
- Do not open the door unless necessary.
- Never cover shelves with aluminum foil or any other material that may prevent air circulation.
- It's recommended to unplug the appliance if it sits empty for long periods. After cleaning, leave the door ajar to allow air to circulate to avoid condensation, mold, or odors from forming.

## ELECTRICAL CONNECTION



Improper use of the grounded plug can increase the risk of electrical shock. If the power cord is damaged, have it replaced by a qualified electrician or authorized service provider.

- This appliance must be properly grounded for your safety. The power cord provided with this unit is equipped with a NEMA 5-15 plug that mates with standard NEMA 5-15 wall outlets to minimize the possibility of electrical shock.
- Using an outlet with a ground fault circuit interrupter (GFCI) is not recommended.
- Never cut or remove the third-ground prong from the supplied power cord.

# IMPORTANT SAFETY INSTRUCTIONS





- Have a qualified electrician check the wall outlet and electrical circuit to ensure the appliance is properly grounded. When a standard two-prong wall outlet is encountered, it is your responsibility and obligation to have it replaced with a properly grounded NEMA 5-15 wall outlet.
- To prevent injury, the electrical cord should be secured behind the appliance and not left exposed or dangling.
- The appliance should always be plugged into its own dedicated NEMA 5-15 electrical outlet. This provides the best performance while preventing overloading wiring circuits that could cause a fire hazard from overheating.
- Have an electrician or qualified professional immediately repair or replace all power cords that have become frayed or otherwise damaged. Never use a cord that shows cracks or abrasion damage. When moving the appliance, be careful not to damage the power cord.
- Never use your appliance with an extension cord unless this cord has been checked and tested by a qualified technician or service person. The extension cord must be a UL/CUL Listed, 3-wire grounding extension cord that has a grounding plug and outlet and an electrical rating of 120 volts and at least 10 amps.



**WARNING:** We do not recommend using an extension cord. If one is used on this appliance, it may void warranty.

# BEFORE INSTALLATION

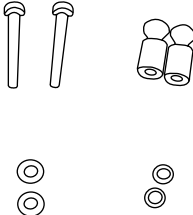
## PROVIDED MATERIALS

IMAGE	DESCRIPTION
	Reversible door upper hinge bracket (1)
	Reversible door lower hinge bracket (1)
	Door handle (1)
	Handle hardware kit (1) - refer to page 14
	Allen/hex key

## MATERIALS NEEDED

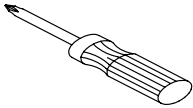
IMAGE	DESCRIPTION
	Phillips-head screwdriver

# BEFORE INSTALLATION

## BEVERAGE FRIDGE PRODUCT SUMMARY

This appliance requires a standard 120VAC/60Hz electrical ground outlet.

SPECIFICATION	MONUMENT BEVERAGE FRIDGE
Model	RBV-US-24
Voltage/Frequency	120VAC/60Hz
Amperage	1.2A
Color	Black Cabinet with Stainless Steel Door
Storage Capacity*	154 cans (12oz)
Refrigerant	R600a
Temperature Range	34°F–50°F (1°C–10°C)
Dimensions**	23 7/16" W x 22 1/2" D x 33 3/4" H (595 mm W x 571 mm D x 857 mm H)

\* Storage capacity is based on standard 12 oz. beverage cans. Shelves can be adjusted to fit bottles of wine or other beverages; capacity will vary.

\*\* Product height varies depending on adjustable legs; 33 3/4" (857 mm) is the minimum height based on legs at their lowest position.

## INTERNAL STORAGE

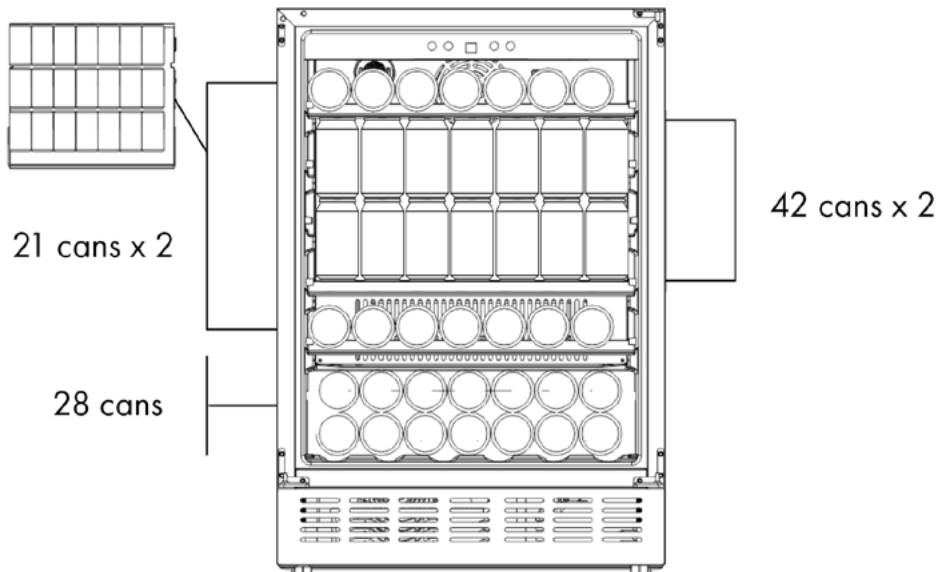

# BEFORE INSTALLATION

## WINE COOLER PRODUCT SUMMARY

This appliance requires a standard 120VAC/60Hz electrical ground outlet.

SPECIFICATION	MONUMENT WINE COOLER
Model	RWV-UD-24
Voltage/Frequency	120VAC/60Hz
Amperage	2.0A
Color	Black Cabinet with Stainless Steel Door
Storage Capacity*	44 Bottles (750ml)
Refrigerant	R600a
Temperature Range	Upper zone: 39°F–50°F (4°C–10°C) Lower zone: 50°F–68°F (10°C–20°C)
Dimensions**	23 7/16" W x 22 1/2" D x 33 3/4" H (595 mm W x 571 mm D x 857 mm H)

\* Storage capacity is based on standard 750 ml Bordeaux-style wine bottles with a 3 3/8" (86 mm) diameter.

\*\* Product height varies depending on adjustable legs; 33 3/4" (857 mm) is the minimum height based on legs at their lowest position.

## INTERNAL STORAGE

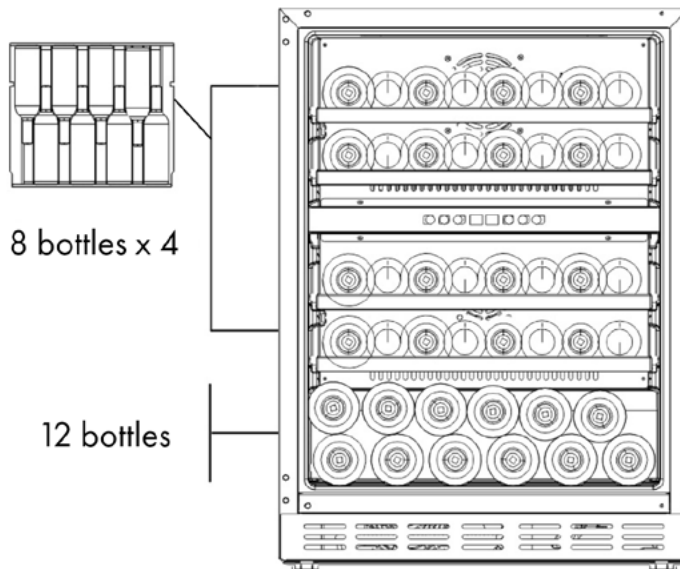



# BEFORE INSTALLATION

## PARTS IDENTIFICATION

### Monument Beverage Fridge (RBV-US-24)

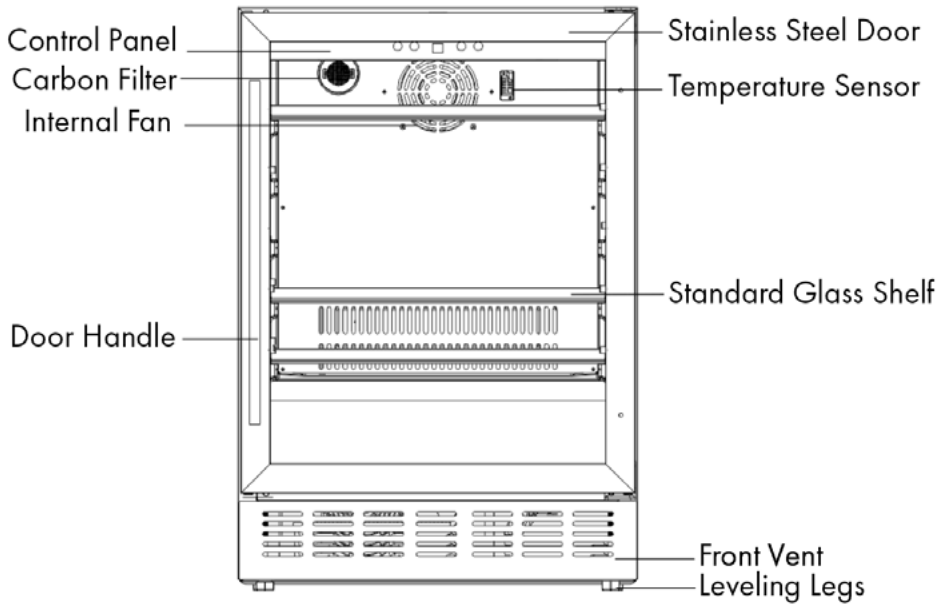

### Monument Wine Cooler (RWV-UD-24)

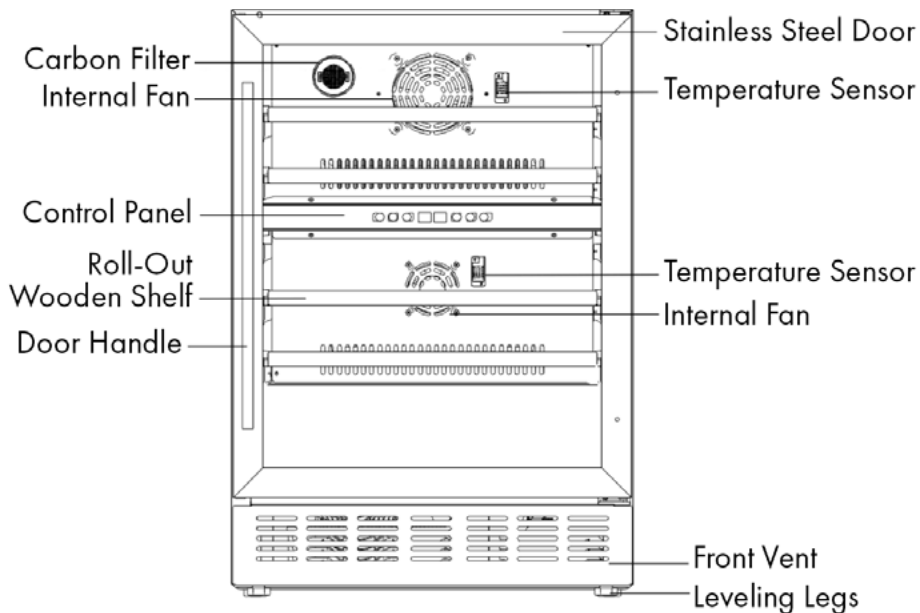

# INSTALLATION

## DIMENSIONS

Dimensions outlined in the images below are the same for both Monument Wine & Beverage Fridges (RWV-UD-24 & RBV-US-24).

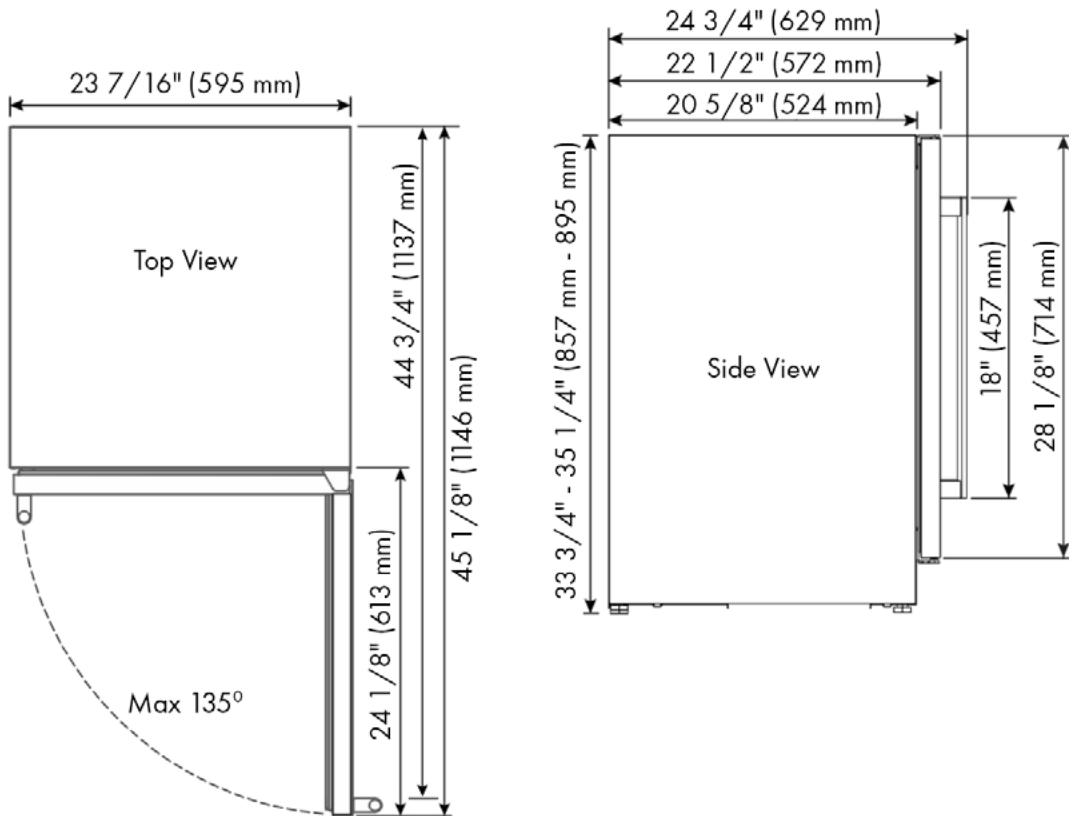

\* **NOTE:** Product height varies depending on adjustable legs, which can be extended by roughly  $1 \frac{1}{2}$ " (38 mm).

# INSTALLATION

## INSTALLATION CLEARANCE REQUIREMENTS

When installing the beverage fridge or wine cooler under a counter, follow the recommended spacing dimensions:

- For proper clearance of the electrical plug, allow at least 1" (25 mm) of clearance behind the appliance.
- Installation next to a wall will require a minimum 2 1/4" (57 mm) door clearance to accommodate the handle to open at least 90°.
- The cabinet should allow at least 24" (610 mm) for width and 34" (864 mm) for height to accommodate the beverage fridge or wine cooler.
- The power cable is located on the bottom back right (left when facing the unit) and is 60" (1524 mm) to accommodate multiple outlet locations.
- Once ready to install, adjust the back two feet to the desired height. Slide into place and adjust the front two feet to ensure the unit is level.
- Installation should allow the unit to be pulled forward for servicing.

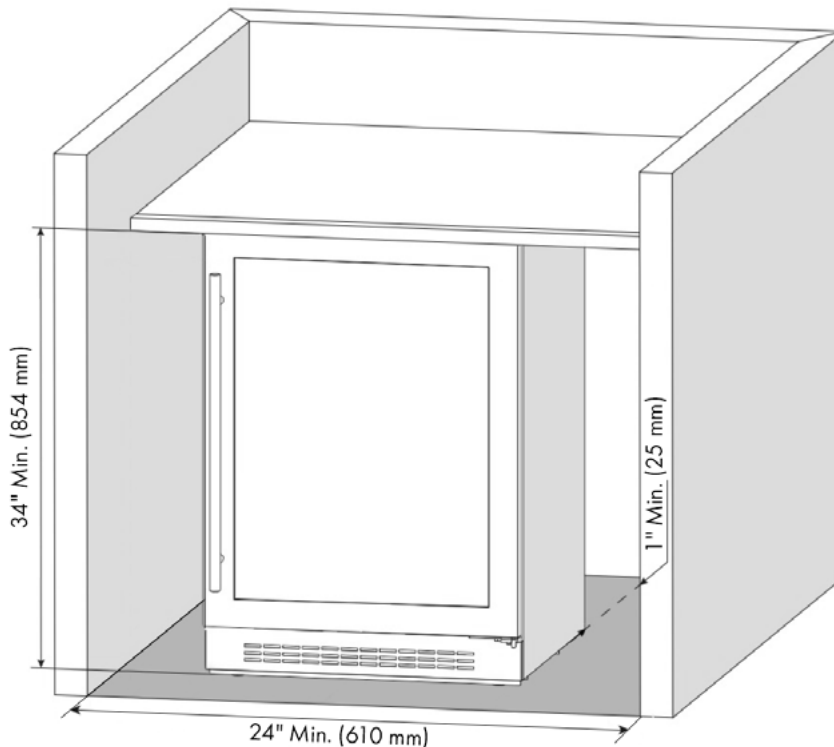

# INSTALLATION

## CARBON FILTER

A built-in carbon filter protects your beverages by acting as a natural barrier against harmful odors. The filter should be replaced every 3-6 months. To replace the filter, search for **BWC-003** on [www.zlineparts.com](http://www.zlineparts.com), ZLINE's official parts distribution partner.

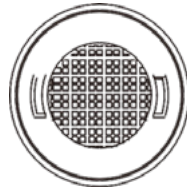

To replace the filter, first remove racks/shelves from the top of the unit to access the filter. Then, using a pair of needle-nose pliers, stick the ends into the slots on each side of the filter, turn either clockwise or counter-clockwise until the slots are at the top and bottom, and then pull out the filter from the rear panel. Put the new filter in and reverse the order.

## INSTALLING THE HANDLE\*

1. Pull back slightly on the door gasket (see image below) to access both screw holes.
2. Place a split lock washer on each screw and insert both into the holes.
3. Facing the front of the door, place the flat washers on both screws and then tighten the mounting studs on each screw until snug.
4. Assemble the handle onto both mounting studs, making sure to note stud direction.
5. Tighten each screw part way using the provided Allen/hex wrench. Once both screws are started, tighten each to be snug. Do not over tighten.

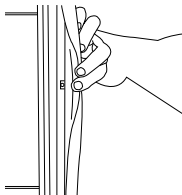

Scan to follow along with a video.

\*Each wine cooler / beverage fridge comes with a handle hardware kit containing two door screws, two mounting studs, two split lock washers, and two flat washers.

# INSTALLATION

## REVERSING THE DOOR SWING OF YOUR APPLIANCE

If you want to reverse the opening direction of the door, follow the instructions below as if the door handle is on the left side of the unit and the door swings out toward you to the right. A second person is recommended to tilt the cooler roughly 30° to help with this task. **NOTE:** Do not tilt the cooler more than 45° or lay it on its back, as that may damage the sealed cooling system. It's recommended to lift the appliance onto a workbench for easier access.

1. Remove the two Phillips-head screws from the axis plate at the bottom of the door to remove the plate; set it and screws aside. Pull out the door from the top and bottom hinge brackets.
2. Take out the three screws from the bottom right hinge bracket and remove. Set the screws aside and hold onto the bracket for future use if you wish to reverse the door swing again.
3. Remove the three screws from the upper right bracket and remove. Set the screws aside and hold onto the bracket for potential future use.
4. Using your fingers or a thin object, remove the three black decorative tabs from the top left of the cabinet. Push those tabs in the three holes where the bracket was removed in step 3.
5. Install the upper hinge bracket from the hardware package included with this manual at the top left of the cabinet with the three screws removed in step 3.
6. Install the new lower hinge bracket at the bottom left of the cabinet with the three screws removed in step 2.
7. Take the axis plate removed in step 1 and slide it onto the bottom of the door with your hand. No screws are needed yet; push the top of the door into the top bracket and then slide the door into the bottom bracket with the axis plate between the door and the bracket.
8. Making sure the axis plate is lined up with the bottom bracket, put in the two screws removed from step 1. **NOTE:** This last step is best for two people — one person to hold the door so the screw holes are aligned, and the other to fasten the screws.

**NOTE:** The door opens to a maximum of 135° with a door stop on the bottom hinge bracket preventing the door from opening further.



Scan to follow along with a video.

# INSTALLATION

## REMOVING THE SHELVES

1. Open the door completely.
2. Remove all of the contents loaded on the shelf, if applicable.
3. Pull the shelf toward yourself until it is fully extended outward.
4. The shelf has plastic tabs on both sides indicated in the diagram below. While facing the unit, press the plastic tab on the right side down while pulling up on the left tab.
5. Evenly pull out the shelf from the track until it is completely removed from the inner compartment.
  - To prevent damaging the door or door gasket, make sure the door is open at least 90° when pulling shelves out of the rail compartment.

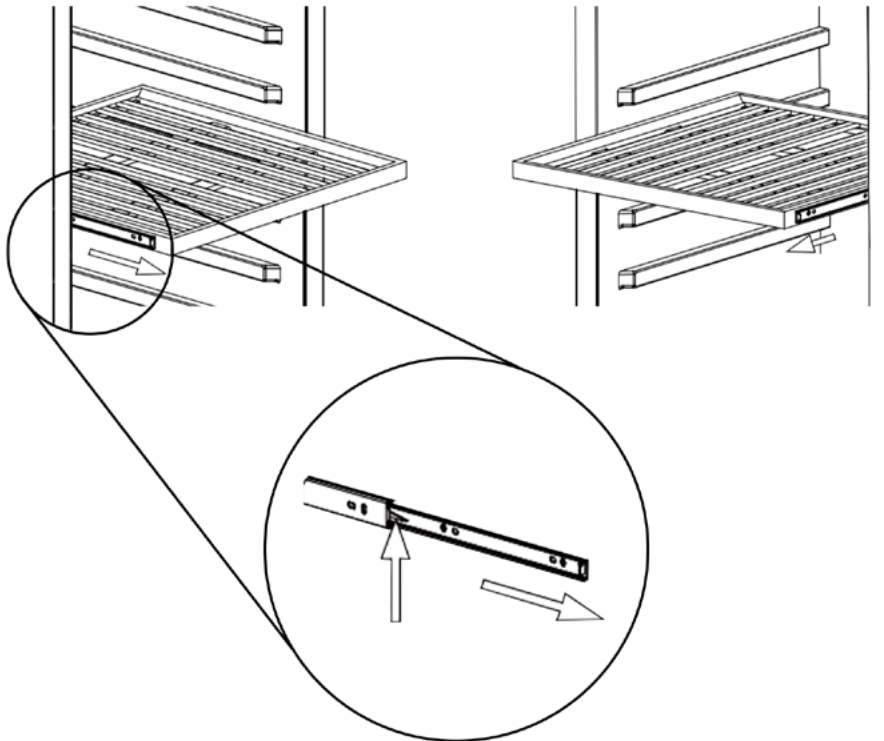

**NOTE:** These installation instructions are for wooden shelves that come with the dual zone wine cooler. ZLINE beverage fridges are equipped with glass shelves. To adjust or remove, open the door completely and simply slide the shelves in and out of the pre-installed metal brackets on the beverage fridge.



# WARRANTY

## COVERAGE

ZLINE Kitchen and Bath ("ZLINE") wine coolers and beverage refrigerators have a two year parts and service warranty and a five year parts warranty on the unit's sealed cooling system.

ZLINE warranty periods begin from the original purchase date of the product and solely cover the original purchaser of the product, delivered new and in its original carton. The limited warranty covers all parts and labor for necessary repairs if any part of the product, or the product itself, proves to be defective in materials or workmanship.

The product must be deemed serviceable via troubleshooting with the ZLINE Customer Experience team. All service on ZLINE products under warranty must be performed by ZLINE-approved and ZLINE-certified service providers unless otherwise specified by ZLINE. Service will be provided during normal business hours.

Products must be unobstructed and accessible to the service provider at the time of service. ZLINE's liability is limited to the original purchase price of the product. Additional injuries, losses, damages, or other inconveniences caused by product malfunction or defects in materials are not covered under the terms of this warranty.

## TERMS

ZLINE warranties apply only to the original purchaser of a ZLINE product installed for normal residential use. This is defined as a single-family, residential dwelling in a non-commercial setting. Any warranty claim stemming from installation, operation, or any other use within a commercial setting is not covered under this limited warranty. Commercial settings include, but are not limited to: schools, churches, hotels, restaurants, vacation rentals such as Airbnb, daycare centers, private clubs, fire stations, common areas in multi-family dwellings, nursing homes, food service locations, and institutional food service locations such as hospitals or correctional facilities.

This warranty is non-transferable and will not under any circumstance be extended based on the date of installation — the warranty period takes effect from the date of purchase and only covers the original purchaser. The warranty applies only to products installed in the contiguous United States and the District of Columbia.

# WARRANTY

Failure to secure certified warranty service per these terms will result in a forfeiture of the remaining warranty. Out-of-pocket payments will not be reimbursed unless prior approval is received from ZLINE and/or ZLINE-certified service contract partners. Unapproved out-of-pocket payments for service will not be reimbursed. All warranty procedures must be followed to maintain warranty coverage.

If a product qualifies within the service window provided under these warranty terms, and ZLINE is unable to repair the product or a defective part of the product after a reasonable number of attempts, ZLINE reserves the right to offer to replace the defective part or the product or provide the original purchaser a full refund of the purchase price of the product (not including installation, removal, or other charges that were not included in the original purchase price).

The original purchaser of the product must provide the original proof of purchase, including the purchase date, when filing a claim to obtain replacement parts, service, or refunds. Additionally, the original purchaser of the product must provide the serial number of the product when filing a claim to obtain replacement parts, service, or refunds.

This warranty shall not apply to any ZLINE product in which the original factory serial number has been removed, altered, or cannot be readily determined for any reason. Further, ZLINE is not responsible for damage resulting from, but not limited to: shipment, delivery, or improper installation; negligence or improper maintenance, misuse, or abuse of the product; unauthorized alteration, modification, or tampering with the product; accident, fire, floods, pest infestations, pandemics, natural disasters, or any other unpreventable or unexplained acts of nature, commonly referred to as "acts of God"; flare-up fires or damages caused by improper electric supply, electrical line current, voltage, or power surges; and service to correct installation not in accordance with the instructions contained in ZLINE's product manuals and/or with local government codes.

In the event service is dispatched, and it is discovered that the reported issue is not covered under warranty based on the disclaimers above, the customer will be responsible for all service fees. Failure to pay these fees will result in the forfeiture of remaining warranty coverage.

# WARRANTY

Information contained within ZLINE's installation and user manuals, in addition to product information included on ZLINE's website and all related digital listings, do not cover every possible condition and situation that may occur during the installation or operation of ZLINE products.

ZLINE reserves the right to make changes at any time to its products when considered safe, necessary, and useful. Always check the ZLINE website for the most up-to-date version of its product manuals: [www.zlinekitchen.com/pages/manuals](http://www.zlinekitchen.com/pages/manuals).

Do not install or operate any ZLINE product if it has missing or broken parts or if it arrives damaged due to shipping. If ZLINE products arrive damaged, contact ZLINE Customer Experience at 1-614-777-5004 for help. Failure to report a damaged appliance prior to installation or operation may void the warranty.

ZLINE disclaims responsibility for damage or injury caused by improper installation or use of any of its products. ZLINE is under no obligation, by law or otherwise, to provide concessions, including repairs, prorates, rebates, discounts, or replacements, once the warranty has expired.

## SERIAL NUMBER LOCATION



**Rating label**



**(located on the back of your unit)**

Please write down the model number and serial number of your appliance. The model number is located on the rating label on the back of your unit. The serial number is located on the top center of the interior on your appliance. Both are needed to obtain warranty service. Do not remove permanently affixed labels, warnings, or plates from the product. This will void the warranty. You may also consider attaching your receipt or proof of purchase to this manual.

# WARRANTY



## SERVICE

For warranty service, please contact our Customer Service team at 1-614-777-5004 or visit [www.zlinekitchen.com/contact](http://www.zlinekitchen.com/contact) to utilize our online Customer Experience Portal.



Scan the QR code to view the most up-to-date version of our Installation Manual and User Manual.



Need to purchase a part or accessory for your ZLINE product? Visit [www.zlineparts.com](http://www.zlineparts.com), ZLINE's official parts distribution partner.

1.5.1

1-614-777-5004

[www.zlinekitchen.com](http://www.zlinekitchen.com)

[contact@zlinekitchen.com](mailto:contact@zlinekitchen.com)

**ZLINE**  
ATTAINABLE LUXURY®