

Quick start installation guide



Zip HydroTap G5

Command Center
Boiling, Chilled & Sparkling models



AFFIX PRODUCT LABEL HERE



English



French

Visit our website to
download the manuals

Table of contents

SECTION 1: Using these instructions	3
SECTION 2: IMPORTANT SAFETY INSTRUCTIONS.....	4
SECTION 3: WARNINGS & REGULATORY INFORMATION.....	7
SECTION 4: Technical data	9
SECTION 5: Parts supplied, consumables and accessories	10
SECTION 6: Set up the ventilation	11
SECTION 7: Fit the carbonation valve.....	14
SECTION 8: Connect the water supply.....	15
SECTION 9: Set the bypass & install the limescale filter	16
SECTION 10: Install the CO ₂ cylinder and regulator	17
SECTION 11: Connect the Command Center.....	20
SECTION 12: Commissioning.....	24
SECTION 13: Performance data sheets	31
Warranty.....	33
Contact details	36

SECTION 1: Using these instructions

Before you start



This document is a Quick Start Installation Guide.
For further details on installing and operating your HydroTap download & read the Command Center installation and user instructions , which can be found online at:

www.na.zipwater.com



Read and use the instructions supplied with individual kit components for a safe installation.

Explanation of symbols



Read the instructions



WARNING



Danger of electric shock



Hot surface



CO₂ Gas
WARNING

SECTION 2: IMPORTANT SAFETY INSTRUCTIONS



Compliance

All Plumbing and Electrical connections must comply with local, state and federal codes.

All Plumbing and Electrical connections must be made in accordance with local regulations.

Ensure the electrical power supply at the installation site is suitable for your HydroTap.

HydroTap models are rated for the following installations:

- Commercial - 220-240VAC 50/60Hz or 230VAC 60Hz
- Residential (120V) - 110-120VAC 50/60Hz

Safety

This appliance is not intended for use by children under 8 years or persons (including children under 8 years) with reduced physical, sensory or mental capabilities, or lack of experience and knowledge, unless they have been given supervision or instruction concerning the use of the appliance by a person responsible for their safety. Children should be supervised to ensure that they do not play with the appliance.

Ventilation

Keep ventilation openings, in the appliance enclosure or in the built-in structure, clear of obstruction.

Do not use mechanical devices or other means to accelerate the defrosting process, other than those recommended by the manufacturer.

Do not store explosive substances such as aerosol cans with a flammable propellant in this appliance.

CO₂

- Keep out of reach of children.
- Use according to MSDS (material safety data sheet).
- Pressurized container. Contains gas under pressure, may explode if heated.
- Protect from sunlight.
- Do not expose to temperatures exceeding 122°F, (50°C).
- Do not expose to naked flame or any incandescent material.
- Do not pierce or burn, even after use. Avoid shock.
- High concentration of gas may cause asphyxiation.



SECTION 2: IMPORTANT SAFETY INSTRUCTIONS

- Use only in an upright position.
- The cylinder must be used with the supplied pressure regulator.
- Store in a location with a volume no less than 65 cubic yards (50 cubic meters) for each 5 lb, (2.27kg) cylinder.
- If more than 1 gas cylinder containing CO₂ is present within the same location, the recommended ventilated area should be in proportion to the number of gas cylinders stored in that location. A ventilated area is a non-enclosed area which could include the kitchen, living room etc.
- Refer to the gas cylinder and MSDS for a complete list of warnings (www.na.zipwater.com).

Qualifications

To avoid hazards, all installation procedures must be carried out by a suitably qualified tradesperson. The power cable and power outlet must be in a safe visible position for connection.

Venting

Sometimes steam and / or boiling water droplets may discharge through a vent outlet on the tap. If not using the font, ensure the tap body is located so the tap outlet safely dispenses into the sink bowl.

Lifting

Take care when lifting. The Command Center may exceed safe lifting limits. If you feel this is beyond your personal capabilities, please seek assistance with the lift. The weight of the Command Center is marked on the packaging. Do not lift the Command Center by the front cover or any of its connections.

Airflow

The ambient operating temperatures, when installed in a cabinet, must be between 41 - 95°F, (5 - 35°C) . The system will operate satisfactorily only with proper air ventilation. Air gaps of 2", (50mm) on each side, and 8", (200mm) above must be provided. See section 6 for correct ventilation details.

Altitude

Water boils at varying temperatures at different altitudes. The HydroTap adjusts for this during startup calibration and will recalibrate itself on a regular basis.

SECTION 2: IMPORTANT SAFETY INSTRUCTIONS

Frost protection

If the HydroTap is located where the ambient air temperature could fall below 41°F , (5°C) when the system is not in use, do not turn off the Command Center electrically. This safeguard does not offer the same protection to the connecting pipework and fittings.

Application

The HydroTap G5 Home series is intended to be used in household and similar applications such as:

- Staff kitchen areas in shops, offices and other working environments;
- Farm houses and by clients in hotels, motels and other residential type environments;
- Bed and breakfast type environments;
- Catering and similar non-retail applications.

SECTION 3: WARNINGS & REGULATORY INFORMATION



- For continued safety of this appliance it must be installed, operated and maintained in accordance with the manufacturer's instructions.
-  The Zip HydroTap must be grounded. Grounding is provided via the supplied power cord. The resistance of the earth connection to each exposed metal part must be less than 1Ω. Use the power cable supplied. It is the responsibility of the installer to ensure the power point is earthed.
- All installation and service work must be completed by trained and suitably qualified tradespeople. Faulty operation due to unqualified persons working on this product may void warranty coverage.
- As the installer, it is your responsibility to supply and install all valves as required by local regulations and relevant standards.
- Do not remove the cover of the appliance under any circumstances without first isolating the appliance from the power supply.
- The new hose sets supplied with the product must be used. Do not re-use old hose sets.
- Never locate the system near, or clean with water jets.
- Do not expose the Zip HydroTap to the elements of nature.
- Due to the process of continuous improvement, Zip reserves the right to change details mentioned in this manual, without notice.
- If this device is not maintained and operated as specified in this document, there is a risk of exposure to contaminants.
- When dispensing hot water, the device can create a scald hazard.
- Use of tools can be hazardous. Assess the risks before you start.
- A clearance envelope around all Command Centers must be provided to allow adequate ventilation for the safe and effective use of the HydroTap system.
- The vent tray, if provided, must be fitted. It provides a efficient ventilation for high capacity products.
- Valve and fitting threads must be sealed appropriately with PTFE tape where compression seals are not provided.
- Always flush new filter before use.
- Do not over tighten plumbing and hose connections.
- Braided hoses supplied cannot be lengthened.

SECTION 3: WARNINGS & REGULATORY INFORMATION

- Be aware of the risks of hazards which could cause harm when handling compressed CO₂. Assess the risks before starting the installation.
- Do not proceed with a CO₂ cylinder change if the seals are damaged. Take care not to cross thread the regulator, a cross threaded regulator poses a potential hazard.
- Care must be taken when working with high pressure carbon dioxide, and in no case should the normal operating pressure of 43.5psi, (3 bar) be exceeded.
- The power cord and general power outlet must be in a safe and accessible position after installation. When positioning the appliance, ensure the power supply cord is not trapped or damaged. If the power supply cord is damaged it must be replaced by a Zip service provider or a qualified electrician.
- Do not locate multiple portable socket-outlets or portable power supplies at the rear of the appliance.
- For safe operation, the HydroTap is designed to be installed, commissioned and used within 48 hours. Should the HydroTap not be required for an extended period of time (72 hours or more), do not fill and commission the HydroTap until ready for first use.
- For water taste and quality reasons, following any non-use period of more than 72 hours, Zip recommends to perform a system flush. Failure to flush the system may affect water quality.

SECTION 4: Technical data

Technical data

Model	220-240V	230V	110-120V	Dimensions W x D x H inch, (mm)	Weight lb, (Kg)
	50/60Hz	60Hz	50/60Hz		
BCS60	9.5A (2150W)	N/A	N/A	15.5 (395) x 18.3 (464) x 13 (333)	90.4 (41)
				With Duct	
				17.7 (450) x 18.3 (464) x 13 (333)	
BCS20	N/A	9.5A (1960W)	N/A	With Duct and Vent Tray: 19.79 (500) x 20.5 (520) x 14.7 (373)	75 (34)
				13.4 (339) x 18.1 (460) x 13 (333)	
BCS Home	N/A	N/A	9.9A (1200W)	13.3 (339) x 18.2 (462) x 13.1 (333)	75 (34)

Electricity supply requirements

110-120VAC 60Hz or 230VAC 60Hz (for power requirement see table above).

Region	Power outlets required
USA	1x 110-120VAC 60Hz or 230VAC 60Hz outlet

Water supply connection

1/2" BSP

Water supply requirements

- A cold water supply with a working pressure range of 37 - 100 psi , (250 - 700 kPa) connected via an isolation valve.
- Water inlet connection size is 1/2" BSP. The system shall only be supplied with cold water.
- Potable water should have a minimum TDS (Total Dissolved Solids) of 50 ppm. In areas where the TDS exceeds 150 ppm and where mineral scale could be a problem, consideration should be given to the maintenance required. Adding a water softener or reverse osmosis system should be considered.

SECTION 5: Parts supplied, consumables and accessories

- Do not use with water that is microbiologically unsafe or of unknown quality without adequate disinfection before or after the system. Systems certified for cyst reduction may be used on disinfected waters that contain filterable cysts.

 A pressure limiting valve must be fitted for mains water pressures above the maximum limits stated above in accordance with local plumbing regulations.

Note: All models have an internal pressure limiting device to reduce the maximum mains regulated pressure protecting the system against pressure surges above 73 psi, (500kPa).

Parts supplied with the HydroTap	BCS for Work	BCS for Home
Tap		
HydroTap faucet	✓	✓
HydroTap pipes, tubes hoses and fittings	✓	✓
Command Center		
Command Center	✓	✓
Mains electrical supply cable	✓	✓
Water supply inlet hose	✓	✓
Water supply inlet adaptor and strainer	✓	✓
Ventilation kit (including vent tray with BCS60 models)	✓	✓
Filters		
Water filter & instructions	✓	✓
Limescale filter kit	Optional	Optional
Drip tray		
Drip tray kit	Optional	Optional

Note: Mains water isolation valve is not supplied with the kit. Contact Zip for the full range of consumables and accessories.

SECTION 6: Set up the ventilation



Use of tools can be hazardous. Assess the risks before you start.



Use instructions supplied with individual kit parts.



A clearance envelope around all Command Centers must be provided to allow ventilation for the safe and effective use of the HydroTap system.

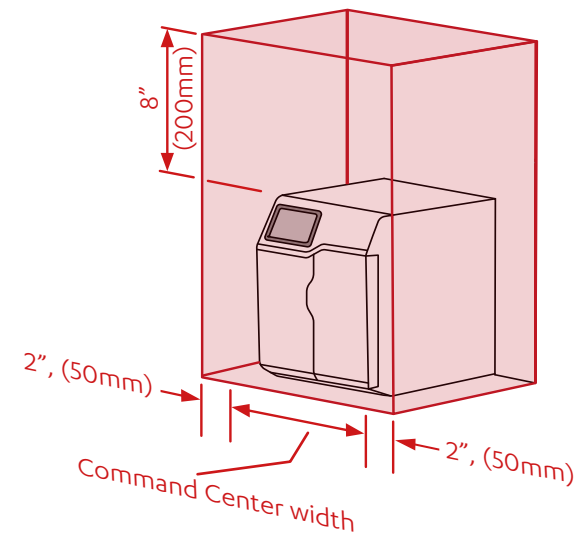

SECTION 6: Set up the ventilation

BCS60 models

- Cold air is drawn in through the inlet vent and gap provided by the door buffers.
- Inlet vent is mounted over cupboard side, door or floor cut-out.
- Warm air is exhausted through vent tray.
- Observe 4", (100mm) inlet / outlet vent separation (see below).



The vent tray must be fitted. It provides a safe exhaust for refrigerant gas in the unlikely event of a leak.

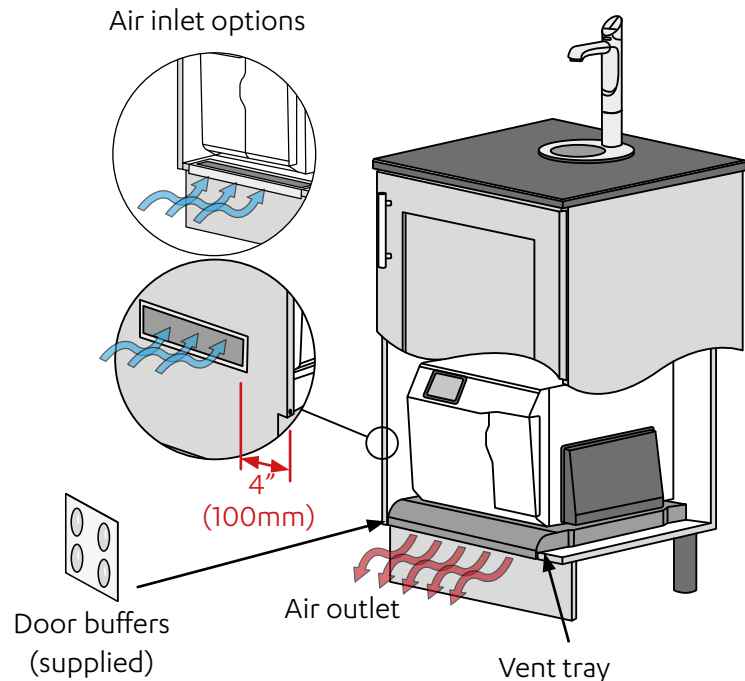

Vent tray dimensions WxDxH inch (mm):
19.7 (500) x 20.3-21.8 (515-555) x 1.6 (40)

SECTION 6: Set up the ventilation

BCS20 & BCS Home models

- Cold air is drawn in through the inlet vent and lower gap provided by the door buffers.
- Inlet vent is mounted over cupboard side, door or floor cut-out.
- Warm air is exhausted through upper gap provided by the door buffers.

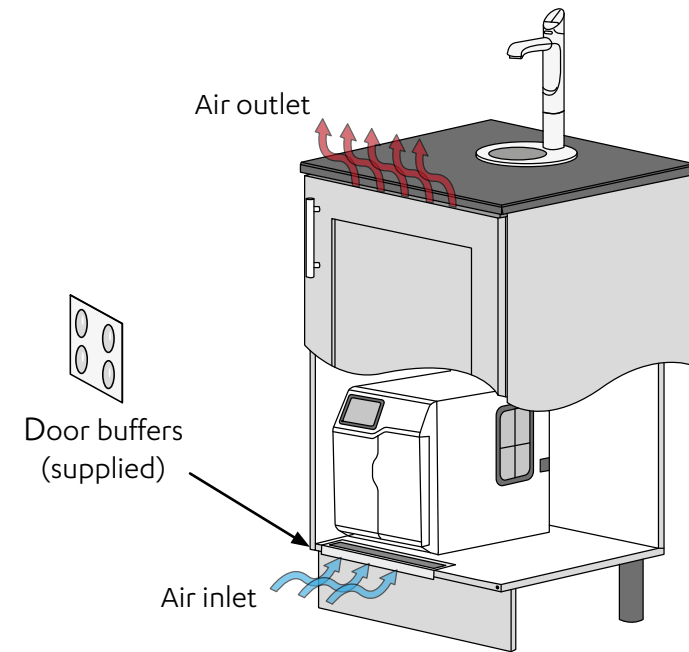

All models

If cupboard temperature exceeds 95°F, (35°C) additional ventilation is required. Contact your Zip service provider for options (including additional vents and fan kit).

SECTION 7: Fit the carbonation valve

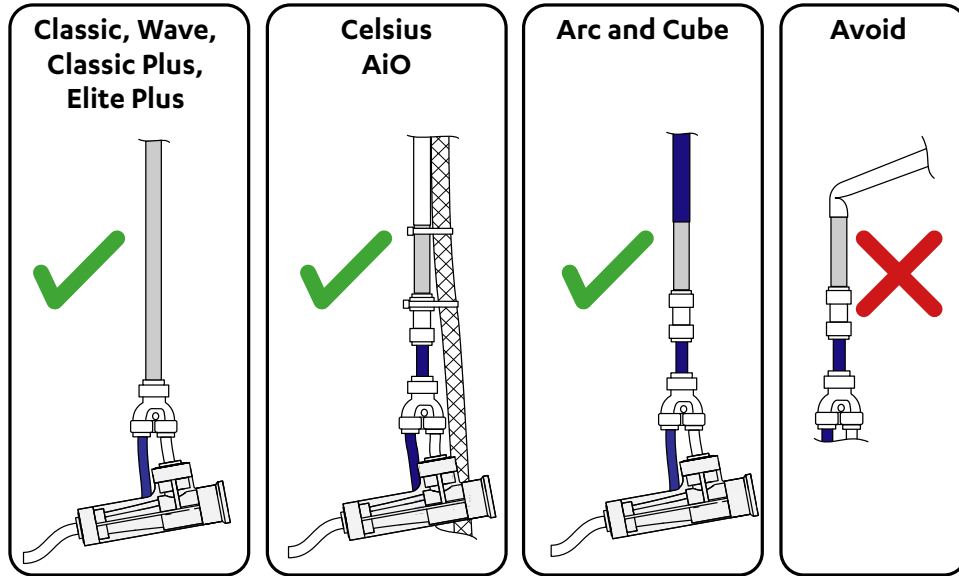

White tube to SPARKLING outlet of Command Center

Carbonation valve flow adjustment

- Use a 6mm Allen key or a large flat-blade screwdriver to adjust the valve.
- Rotate the adjustment screw anti-clockwise to increase, and clockwise to decrease the flow.
- To measure the set flow rate, use a measuring jug or cup and run the sparkling water for 15 seconds. The HydroTap has a default 15 second dispense time, which will help in your flow rate setup.
- Multiply the amount of water dispensed in 15 seconds by 4 to determine the flow rate in liters per minute.
- The minimum flow rate required is 0.4 gallons, (1.6 liters) per minute.
- If the flow rate is adjusted too high, the carbonation tank will be emptied of water, leaving only CO₂ to be dispensed from the tap. This will result in inconsistent flow (spluttering).

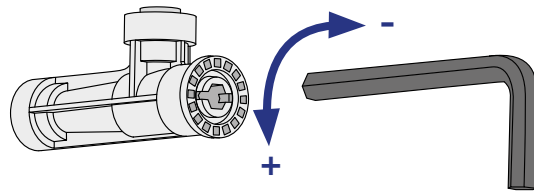

SECTION 8: Connect the water supply



Valves and fittings must be sealed with PTFE tape if compression seals are not included.

Note: Mixer tap installations also use a 'tee piece' as part of the water supply plumbing connections, see the Tap installation instructions supplied with the Mixer Tap to connect the water supply if using the mixer tap option.

Note: Correct strainer orientation.

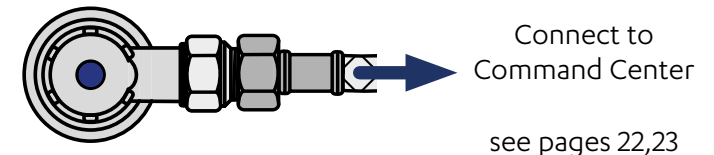
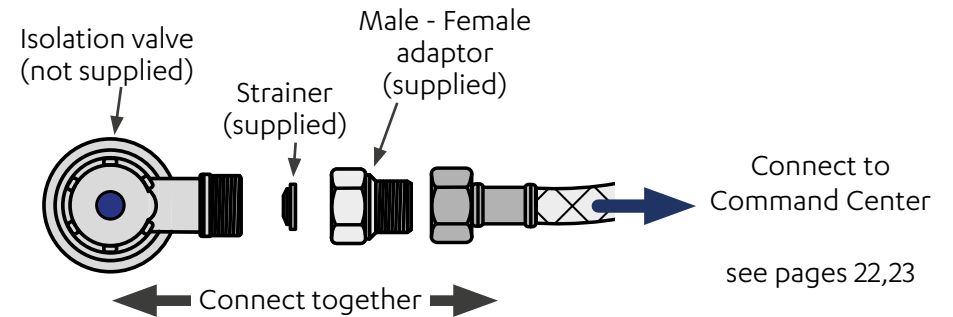

SECTION 9: Set the bypass & install the limescale filter

Available as optional accessory.



For filter head and scale filter installation use the guide supplied with the filter head and filter respectively.



Flush filter before use.

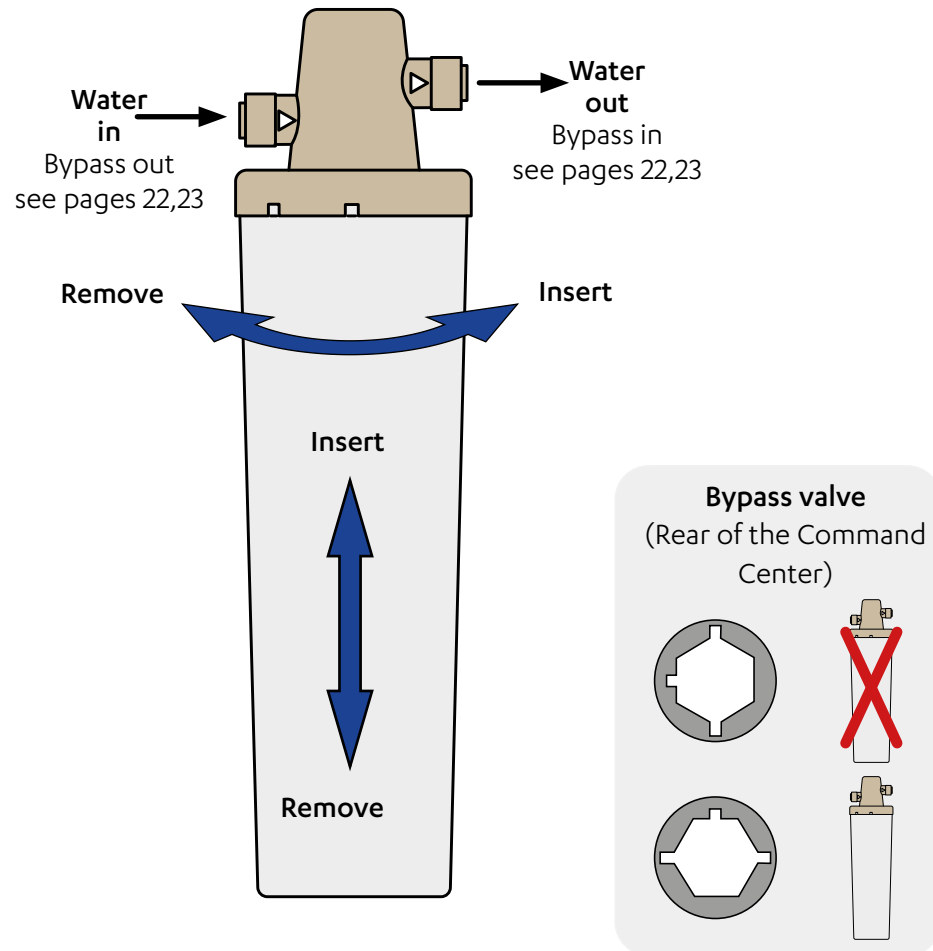

SECTION 10: Install the CO₂ cylinder and regulator

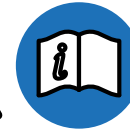

Be aware of the risks of hazards which could cause harm when handling compressed CO₂.
Read the safety warnings at the start of this instruction manual. Assess the risks before starting the installation.

- CO₂ cylinders are available in two sizes:
- 1.5lb [24oz](0.67 kg) [approx. 30 gal. (112 liters)] for residential use.
- 5.0lb [80oz] (2.27 kg) [approx. 100 gal. (378 liters)] for commercial use.

Secure the cylinder

- Ensure there is sufficient space to safely secure the cylinder and regulator.
- Secure cylinder vertically to a robust surface with the hook & loop strap and bracket supplied.

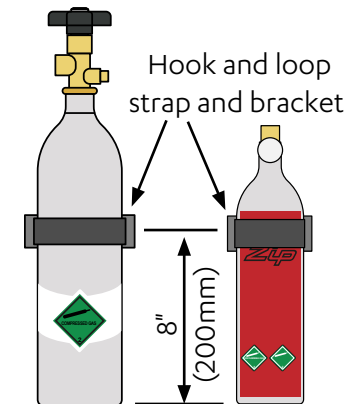

Fit the regulator and connect the gas hose

- See illustrations on page 18.
- Ensure all mating surfaces are clean and cylinder valve is turned off.
- Turn the regulator OFF, (fully anticlockwise).
- Check the regulator and hose seals, inside the connectors.
- Carefully screw the regulator onto the cylinder connection.
- Connect the CO₂ gas hose to the regulator.
- Connect the CO₂ gas hose to the Command Center.

SECTION 10: Install the CO₂ cylinder and regulator



Do not proceed if the seals are damaged.
Take care not to cross thread the regulator, a cross threaded regulator poses a potential hazard.

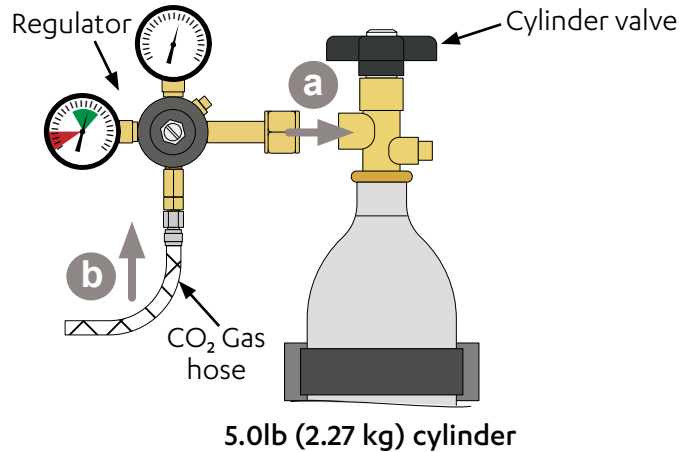

5.0lb (2.27 kg) cylinder

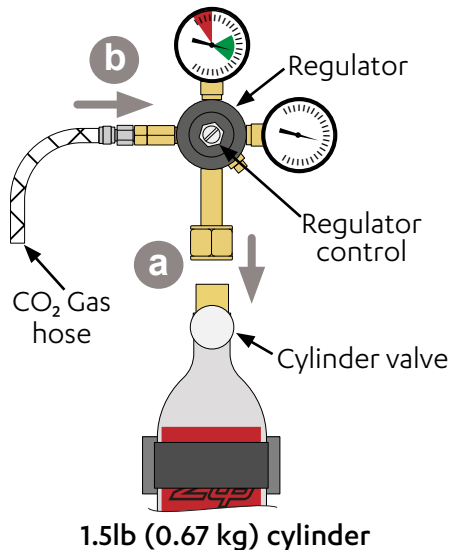

1.5lb (0.67 kg) cylinder

SECTION 10: Install the CO₂ cylinder and regulator

Adjust the G5 regulator

- Check the regulator control is turned all the way OFF (anti-clockwise).
- Turn the CO₂ gas ON using the cylinder valve, (anti-clockwise). (dual-gauge regulator).
- Turn the regulator control (clockwise +) to adjust the outlet pressure to 44psi (3.0 bar) on the outlet pressure gauge.

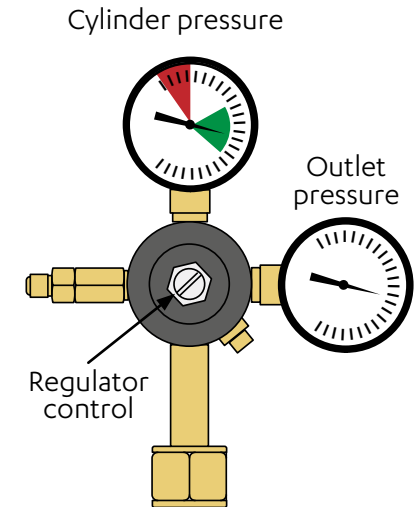

Test for leaks



Care must be taken when working with high pressure carbon dioxide, and in no case should the normal operating pressure of 44 psi (3 bar) be exceeded.

- Apply soapy water to the gas connections (see below), using a brush.
- If there is a leak, bubbles will appear.

● Test for leaks in these areas

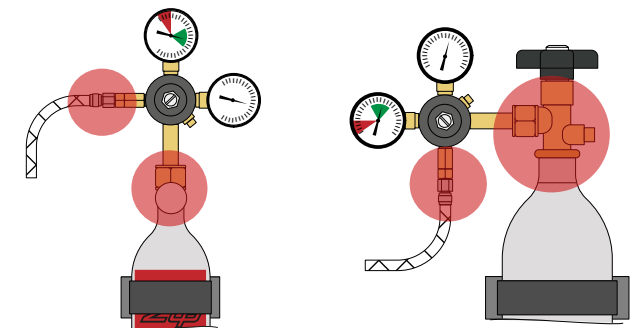

SECTION 11: Connect the Command Center

Generic installation instructions



For HydroTap, mixer tap and any optional accessories, use instructions supplied with individual kit components.

Mains power cable

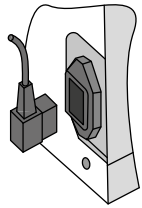

USB

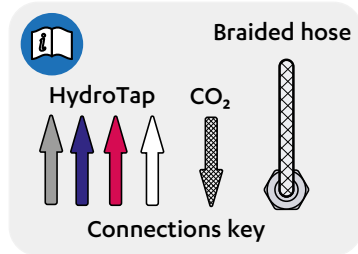
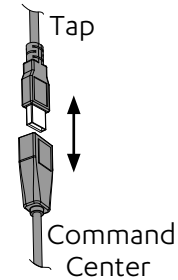

Warning: HydroTap models are available for either 110-120VAC 50/60Hz or 230VAC 50/60Hz installations. Ensure the electrical power supply at the installation site is suitable for your HydroTap. Use only the power lead supplied with the product. Connect the power lead to the HydroTap and connect the plug into the electrical power outlet, ensuring both ends are securely engaged to reduce the risk of overheating.

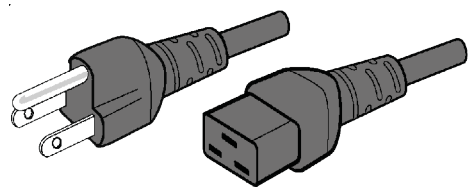

Power lead for 110-120V, 60Hz ONLY (NEMA 5-15 / IEC C19)

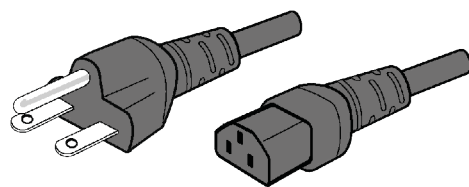

Power lead for 230V, 60Hz ONLY (NEMA 6-15 / IEC C13)

SECTION 11: Connect the Command Center

John Guest pipe and fittings

Take care to use correctly, see below :

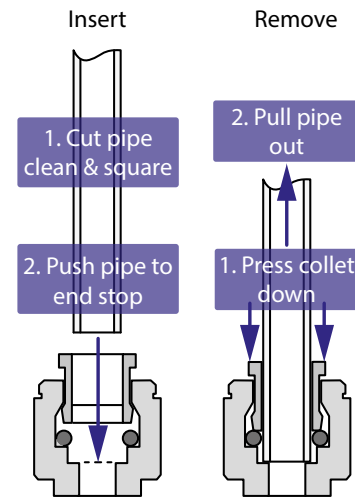

Installation diagrams are for illustrative purposes only. Hoses are not shown to scale and cannot be lengthened.

Tips for hose connection

- Push the silicone hose over the connector for a minimum of 0.6", (15mm).
- Ensure there a constant fall from the tap down to the command Center.
- Hoses must be trimmed to avoid loops and kinks. Take care when positioning before cutting and make a clean cut straight across the hose, using a sharp blade.
- The hoses must not be under tension when installed.

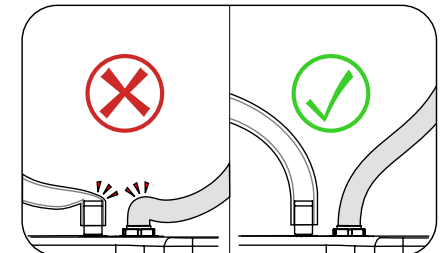
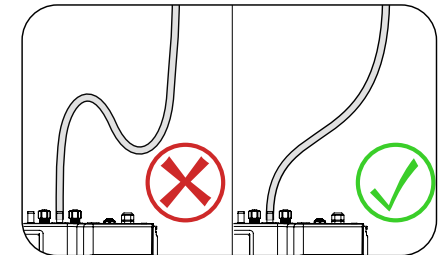

SECTION 11: Connect the Command Center

BCS60 models

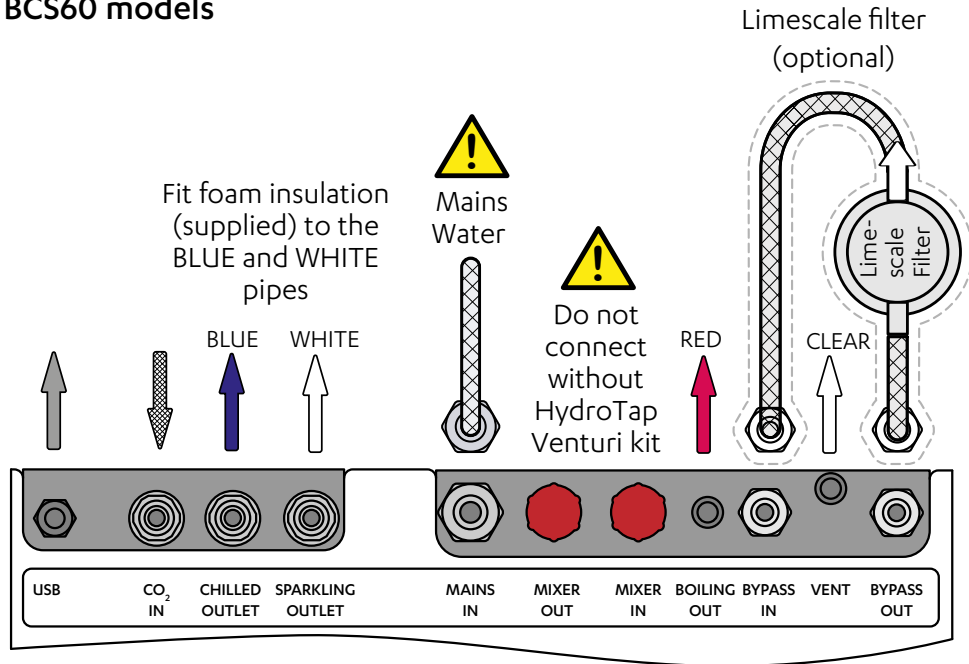

Example installation

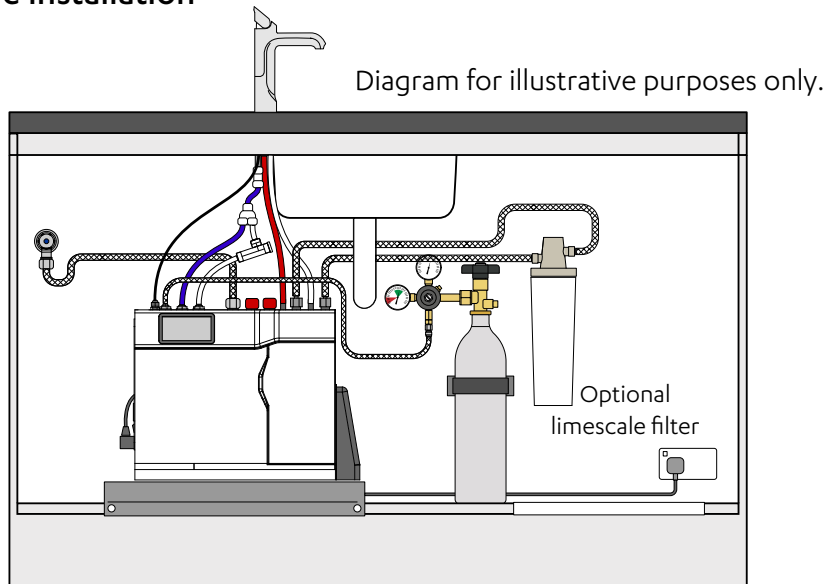

SECTION 11: Connect the Command Center

BCS20 & BCS Home models

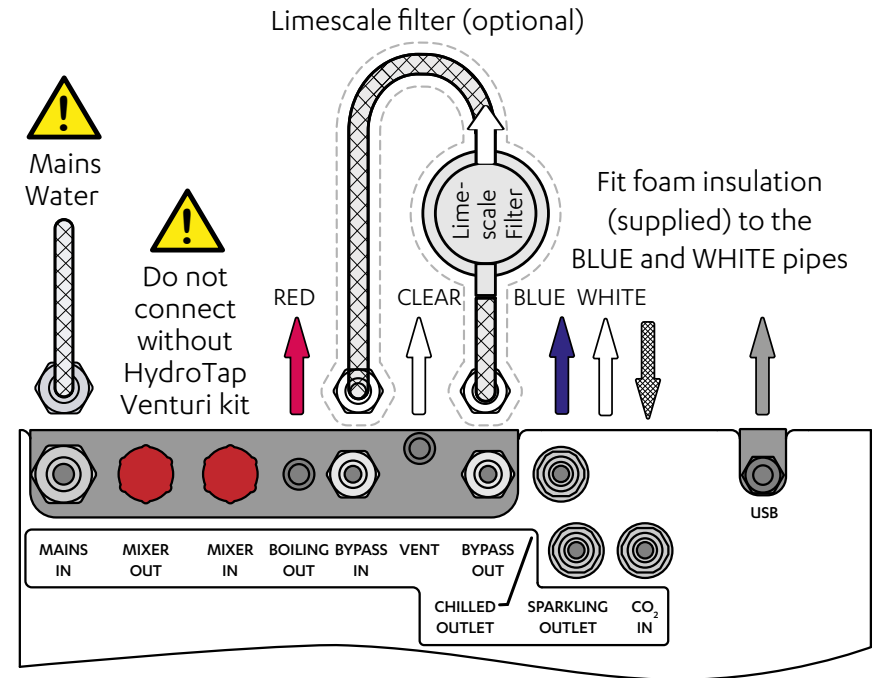

Example installation

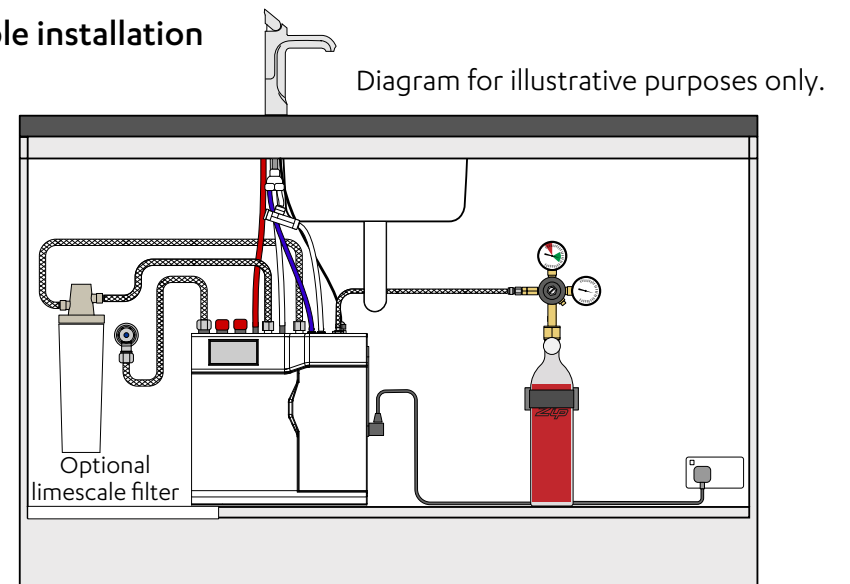

SECTION 12: Commissioning



For a more detailed discretion of the commissioning process, refer to the Command Center installation and user instructions

Install the filter cartridge

- Unpack filter cartridge, remove sanitary cap.
- Write today's date where shown on the label.
- Avoid touching the filter o-rings and filter opening as this may cause bacterial contamination of the cartridge.
- Moisten the o-rings with water.
- Open the filter door on the Command Center.
- Align the front cartridge label to the left, and push the new cartridge up into the filter head.
- Turn the cartridge a quarter turn anticlockwise until it comes to a complete stop and locks, with the front label facing forward.

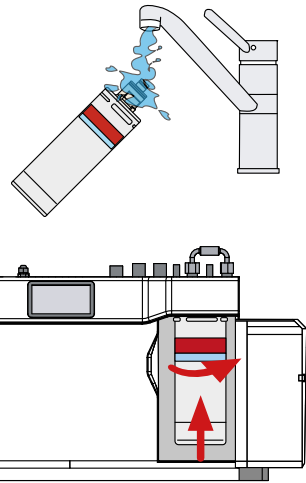

Turn on the supplies & familiarize yourself with the system

- Connect the mains electrical power cable to the supply.
- Turn the power and water on and check for any leaks.
- Familiarize yourself with the operation of the tap and GUI screen in preparation for use, see the user guide.

Select the language, date / time & drain away options

- Initial commissioning screen touch Language option.
- Touch the appropriate button to select the language and units of choice.
- Touch the back arrow to go back to previous menu.
- In the previous menu, touch the arrow to begin the commissioning process.

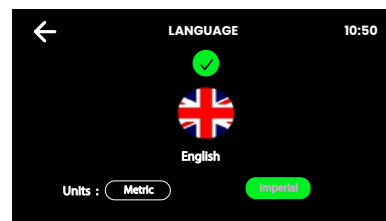
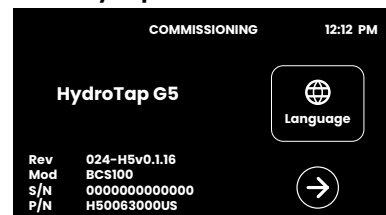

SECTION 12: Commissioning

- Touch the arrow to continue when ready to start using the HydroTap.
- Touch the date and time, use "-" or "+" to make adjustments. When ready, touch the arrow to continue.
- Select 'Sink / Container' or 'Drip tray' depending on the model, see below.
- Select 'Drip tray' if the HydroTap is mounted on a drip tray.
- Select 'Sink / Container' if the HydroTap is mounted such that the waste water dispenses into a sink, or container.

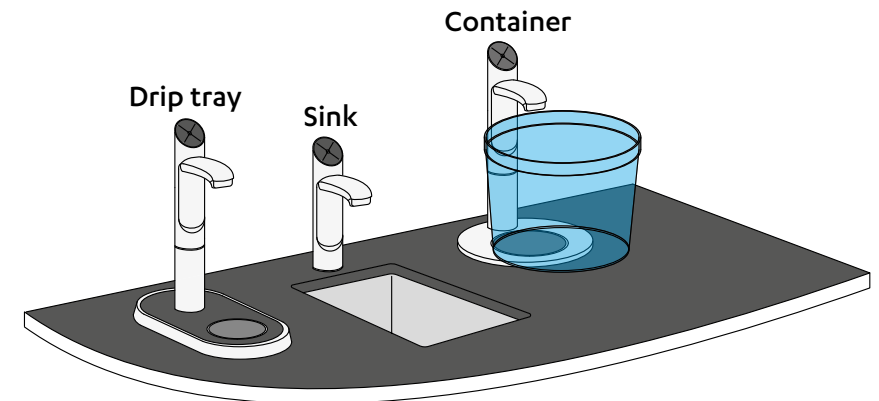
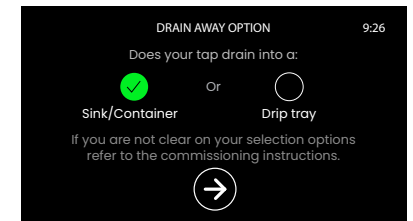
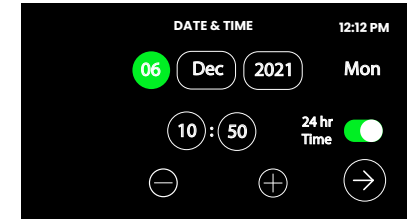
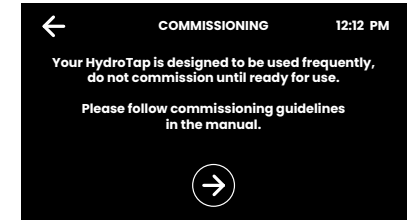

- **Note** This selection will determine if water is dispensed automatically or requires operation of the tap during the tank flush process.
- Touch the arrow to continue.

SECTION 12: Commissioning

Filter flush

- Follow the steps on-screen to flush the filter.
- Open filter door & uncoil flush line.
- Direct flush line into bucket.
- Place a cloth or towel under the filter cartridge to catch any water that may spill.
- Open the shut-off valve.
- Start filter flush.

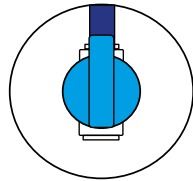
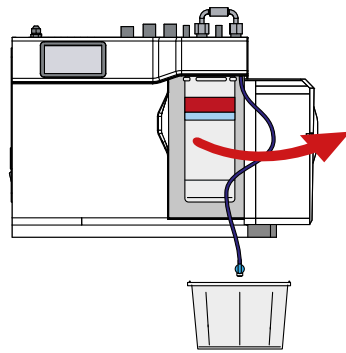

Shut-off valve open

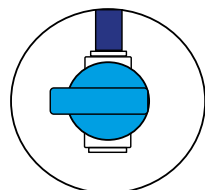
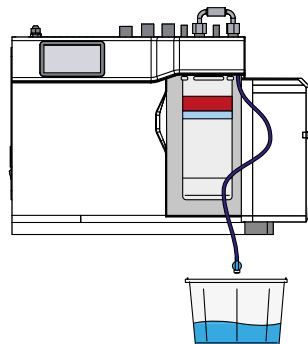

Shut-off valve closed

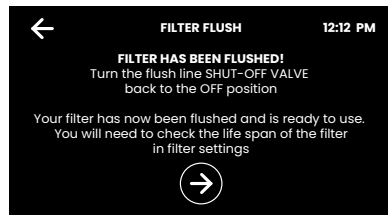
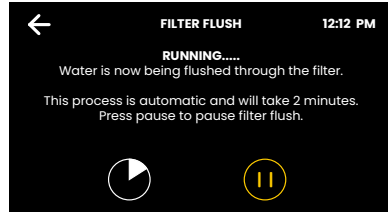
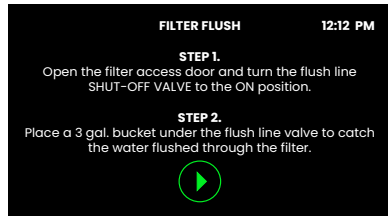

- Once the filter flush is finished, close the shut-off valve.
- Wipe up any spills.
- Close the door to secure the appliance.

SECTION 12: Commissioning

Tank flush (does not apply to chilled sparkling models)

- Follow the instructions to flush the tanks. Dispense water from the tap if instructed.
- **Note** The 'Auto Dispense' option will be enabled/disabled based on the selection made in the drain away option screen. It can be altered by touching the toggle button.
- **Note** Care should be taken if enabling 'Auto Dispense' if the tap drains over a font as it may overflow during the tank flush.
- Make a selection and press Run to start the tank flush.
- If 'Auto Dispense' is enabled the tanks will fill and empty automatically except if the water in the hot tank is above 122°F, (50°C). In this case follow the prompts on the screen to utilize the tap and its safety feature to empty the hot tank.
- If 'Auto Dispense' is disabled the tanks will fill automatically. When prompted use the tap to dispense water and empty the tanks. If the hot tank has water above 122°F, (50°C) then use the taps safety feature to dispense.

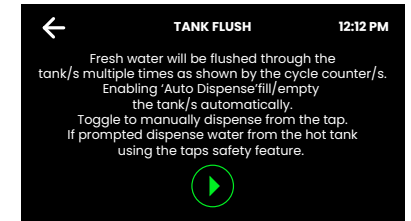

BCS Models

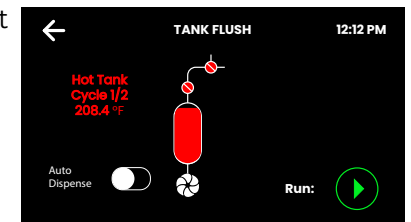

Boiling calibration

- Press the green button and the system will start the boiling calibration procedure. This can take up to 10 minutes.
- **Note** For BCS models the compressor will turn on to pre-cool the cold system.

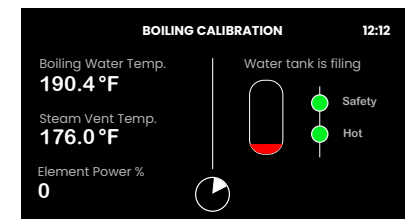
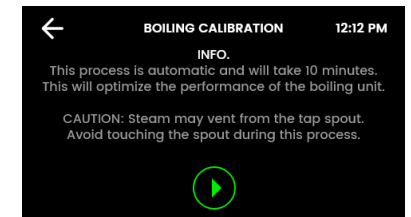

SECTION 12: Commissioning

CO₂ purge

- CO₂ life settings should be adjusted for the size of the CO₂ bottle connected.
- Use the skip arrow to end the CO₂ purge process prematurely if all water has been purged and only gas can be heard coming from the tap.

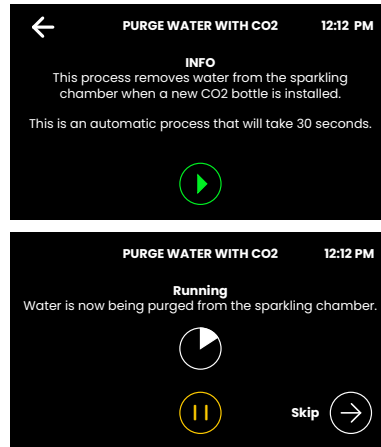

Adjust the carbonation valve

- See section 7.

Safety sensor calibration (Classic boiling models only)

Optional, in cases where light recalibration is required.

Light intensity varies from site to site, therefore it is recommended that a re-calibration be performed at the time of the installation. All direct sunlight must be shaded from the HydroTap, during the calibration. This can be achieved by closing any nearby curtains, blinds, etc.

- Shield the HydroTap from direct sunlight.
- In normal operating mode. Turn the power off.
- Pull both tap levers to the forward position.
- Turn the power on.
- The safety sensor will calibrate.
- Return the levers to the neutral position.

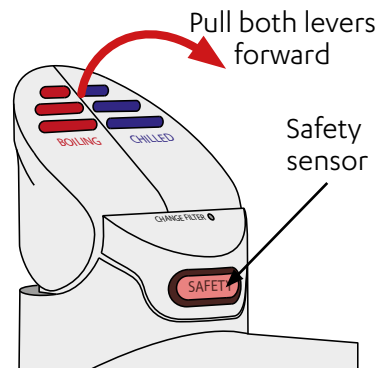

SECTION 12: Commissioning

Backflow Prevention

All HydroTap models that have sparkling/carbonated water functionality include the following integral Backflow Prevention.

Main Water Inlet

The Dual Check Valve (DCV) on the Mains Water inlet connection is designed to ensure a uniform direction of flow throughout the HydroTap. This valve configuration eliminates any possible contamination of the mains water supply, caused by backflow or back siphonage and is a secondary safety feature in the case of the inlet safety solenoid. The DCV also maintains a constant pressure upstream of the inlet safety solenoid. There are two (2) operating principles:

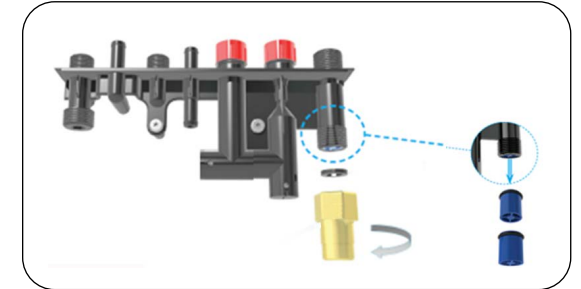

- Firstly, one check valve will still act, even if the other is jammed open;
- Secondly, the closure of one valve reduces the pressure differential across the other, allowing a more reliable seal and avoiding the possibility of minor leakage.

The HydroTap MUST NOT be operated without the Dual Check Valves in place.



Internal Carbonator

There are two (2) Check Valves on the internal Carbonator. The Check Valves ensure the flow of CO₂ gas and water is maintained in one direction, into the carbonator. These valves help to maintain the pressure needed to ensure the gas remains dissolved in the water while inside the carbonator. The Check Valves are designed to stop any backflow of gas and/or water out of the internal carbonator.

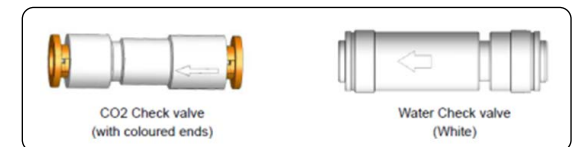

In addition to the HydroTap's integral Backflow prevention

SECTION 12: Commissioning

Some authorities require additional Backflow Prevention to be installed to comply with the Local, State or Federal plumbing code requirements. Both the Universal Plumbing Code (UPC) and National Standard Plumbing Code (NSPC) require the use of an American Society of Sanitary Engineers (ASSE) 1022 backflow preventer on the supply to carbonators under UPC 603.5.12 and NSPC 10.5.8.

UPC: “Potable water supply to beverage dispensers, carbonated beverage dispensers, or coffee machines shall be protected by an air gap or a vented backflow preventer in accordance with ASSE 1022. For carbonated beverage dispensers, piping material installed downstream of the backflow preventer shall not be affected by carbon dioxide gas”.

NSPC: “The water supply to a carbonated beverage dispenser shall be protected against backflow with an integral backflow preventer conforming to ASSE 1022 or an air gap. Carbonated beverage dispensers and carbonated beverage dispensing systems without an integral backflow preventer conforming to ASSE 1022 or an air gap shall have the water supply protected with double check valve and atmospheric vent conforming to ASSE 1022.”

In order to comply with this requirement the Installer MUST install an ASSE 1022 approved backflow device on the water supply leading to the HydroTap. This will ensure compliance with the requirement to protect the potable water supply to the carbonated beverage dispenser.

SECTION 13: Performance data sheets

Performance Data Sheet

Zip HydroTap G5 BCS Home with ARC XX, CUBE XX, Celsius AIO XX, Classic XX, Wave XX, Classic Plus XX, Elite Plus XX, ARC Plus XX, and CUBE Plus XX faucets.

Manufacturer: Zip Heaters (Aust) Pty Ltd

67 Allingham Street, Condell Park NSW 2200 Australia

Distributed in US and Canada by: Culligan International Company

Call Zip’s US distributor Culligan International Company on US Toll Free 1-833-233-2358 for assistance, service, spare parts or enquiries.

Testing Conditions and Results:

Flow Rate: 1 gpm , Pressure: 60 psig ± 3, Temperature: 68 ± 5 °F, Capacity: 1,100 gallons, pH: 7.5 ± 0.5

Operating Conditions

Minimum Working Pressure: 37 psi (2.60 kg/cm²) Minimum Operating Temperature: 41 °F (5 °C)

Maximum Working Pressure: 100 psi (7.03 kg/cm²) Maximum Operating Temperature: 95 °F (35 °C)

Electrical Characteristics: 110-120V/60Hz

Replacement Cartridge: 1Z-LS (Culligan P/N 01034276)

Operating TDS: 50 ppm – 150 ppm

Cartridges manufactured for Zip by Pentair Everpure, EPA Est. No. 002623-IL-002.
Replacement cartridges can be purchased from your local Culligan dealer, Zip dealer or other Zip approved distributors.

Substance Reduction

This system, used in conjunction with the above-mentioned filter cartridge, has been certified by IAPMO R&T according to NSF/ANSI 42 and NSF/ANSI 53 for reduction of the substances listed below as verified and substantiated by test data.

The concentration of the indicated substances in water entering the system was reduced to a concentration less than or equal to the permissible limit for water leaving the system as specified in NSF/ANSI 42 and NSF/ANSI 53.

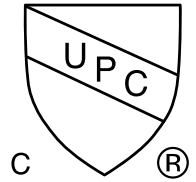

Substance	Average Influent Challenge Concentration	Max. Permissible Product Requirements	Reduction Requirements	Average Reduction
NSF/ANSI 42 – Aesthetic Effects				
Bacteriostatic Effects	Unit passes NSF/ANSI 42 for Bacteriostatic effects.			
Chlorine, Taste and Odor	2.0 mg/L ± 10%		≥ 50%	97.4%
Nominal Particulate Reduction, Class I (≥ 0.5 µm to < 1 µm)	10,000/mL		≥ 85%	99.3%
NSF/ANSI 53 – Health Effects				
Cyst	Minimum 50,000/L		≥ 99.95%	99.99%
Lead, pH 8.5	0.15 mg/L ± 10%	0.005 mg/L	≥ 96.67%	98.9%
Lead, pH 6.5	0.15 mg/L ± 10%	0.005 mg/L	≥ 96.67%	99.3%

*Available in a range of premium metallic finishes. XX refers to the specific finish of the faucet: Chrome, Brushed Chrome, Matte Black, Rose Gold, Nickel, Brushed Nickel, Gunmetal Gray, Brushed Gold.

Do not use with water that is microbiologically unsafe or of unknown quality without adequate disinfection before or after the system. The term ‘bacteriostatic’ means that the system limits the passage or growth of bacteria that may already exist in the incoming water. It does not mean that the water leaving the system is safer to drink than the water entering the system.

Systems certified for cyst reduction may be used on disinfected waters that may contain filterable cysts.

See the installation manual for installation, maintenance requirements and warranty.

Performance Indicator: Filter Light on LED faucet. Full text notification on LCD display.

To maintain product certification and ensure uniform performance, the product is retested on a consistent basis.

Name & Signature: Buyer

Date

Name & Signature: Seller

Date

SECTION 13: Performance data sheets

Performance Data Sheet

Zip HydroTap G5 BCS60, HydroTap G5 BCS20 with ARC XX, CUBE XX, Celsius AIO XX, Classic XX, Wave XX, Classic Plus XX, Elite Plus XX, ARC Plus XX, and CUBE Plus XX faucets.

Manufacturer: Zip Heaters (Aust) Pty Ltd

67 Allingham Street, Condell Park NSW 2200 Australia

Distributed in US and Canada by: Culligan International Company

Call Zip's US distributor Culligan International Company on US Toll Free 1-833-233-2358 for assistance, service, spare parts or enquiries.

Testing Conditions and Results:

Flow Rate: 1.5 gpm , Pressure: 60 psig \pm 3, Temperature: 68 \pm 5 °F, Capacity: 1,800 gallons, pH: 7.5 \pm 0.5

Operating Conditions

Minimum Working Pressure: 37 psi (2.60 kg/cm²) Minimum Operating Temperature: 41 °F (5 °C)
 Maximum Working Pressure: 100 psi (7.03 kg/cm²) Maximum Operating Temperature: 95 °F (35 °C)
 Electrical Characteristics: 220-240V 50/60 Hz or 230V 60 Hz
 Replacement Cartridge: 1.5Z-LS (Culligan P/N 01034277)

Operating TDS: 50 ppm – 150 ppm

Cartridges manufactured for Zip by Pentair Everpure, EPA Est. No. 002623-IL-002. Replacement cartridges can be purchased from your local Culligan dealer, Zip dealer or other Zip approved distributors.

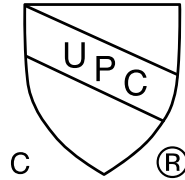

Substance Reduction

While testing was performed under standard laboratory conditions, actual performance may vary. This system, used in conjunction with the above-mentioned filter cartridge, has been certified by IAPMO R&T according to NSF/ANSI 42 and NSF/ANSI 53 for reduction of the substances listed below. The concentration of the indicated substances in water entering the system was reduced to a concentration less than or equal to the permissible limit for water leaving the system as specified in NSF/ANSI 42 and NSF/ANSI 53.

Substance	Average Influent Challenge Concentration	Max. Permissible Product Requirements	Reduction Requirements	Average Reduction
NSF/ANSI 42 – Aesthetic Effects				
Bacteriostatic Effects	Unit passes NSF/ANSI 42 for Bacteriostatic effects**.			
Chlorine, Taste and Odor	2.0 mg/L \pm 10%		\geq 50%	97.4%
Nominal Particulate Reduction, Class I (\geq 0.5 μ m to $<$ 1 μ m)	10,000/mL		\geq 85%	99.3%
NSF/ANSI 53 – Health Effects				
Cyst	Minimum 50,000/L		\geq 99.95%	99.99%
Lead, pH 8.5	0.15 mg/L \pm 10%	0.005 mg/L	\geq 96.67%	98.9%
Lead, pH 6.5	0.15 mg/L \pm 10%	0.005 mg/L	\geq 96.67%	99.3%

*Available in a range of premium metallic finishes. XX refers to the specific finish of the faucet: Chrome, Brushed Chrome, Matte Black, Rose Gold, Nickel, Brushed Nickel, Gunmetal Gray, Brushed Gold.

Do not use with water that is microbiologically unsafe or of unknown quality without adequate disinfection before or after the system. The term 'bacteriostatic' means that the system limits the passage or growth of bacteria that may already exist in the incoming water. It does not mean that the water leaving the system is safer to drink than the water entering the system. Systems certified for cyst reduction may be used on disinfected waters that may contain filterable cysts.

See the installation manual for installation, maintenance requirements and warranty.

Performance Indicator: Filter Light on LED faucet. Full text notification on LCD display.

To maintain product certification and ensure uniform performance, the product is retested on a consistent basis.

Name & Signature: Buyer _____ Date _____ Name & Signature: Seller _____ Date _____

Warranty

Limited Warranty- Zip Products

What Does This Warranty Cover?

Culligan International Company, d/b/a Zip Water, (hereinafter "Zip"), warrants to the original purchaser (the "Zip Customer") of the Zip product (the "Zip Product"), so long as the Zip Customer purchased the Zip Product from an authorized Zip dealer ("Authorized Zip Dealer"), that this Zip Product, including any of its original accessories, is free of defects in material and workmanship, subject to the terms and conditions set forth herein. This Limited Warranty covers parts and labor, except as set forth in this Limited Warranty

Where Is This Limited Warranty Valid?

This Limited Warranty is only applicable if the Zip Product was installed in the United States of America ("USA") or Canada.

What Is Required to Request Warranty Service?

All three of the following are required before warranty service will be performed: (1) Verification of the purchase date; (2) Verification that the Zip Product was purchased from an Authorized Zip Dealer; and (3) Verification that the Zip Product at issue was installed by an authorized Zip service technician or an approved Zip service provider.

When Does the Limited Warranty Expire?

Two (2) Year Limited Warranty - Any warranty claims for Zip Products must be received by Zip within 15 months from the date of purchase or within 12 months from date of installation. This warranty guarantees that if any part should fail within 15 months from date of purchase or within 12 months from the date of installation, except as detailed below, Zip or its authorized service provider will repair or replace the Zip Product. Determination to repair or replace will be in Zip's sole discretion. Repair or replacement services will be at no cost to the Zip Customer, provided that:

- the Zip Product is installed and used strictly in accordance with the instructions supplied; and
- all service under the Two (2) Year Limited Warranty is carried out only by an authorized Zip service technician or an approved Zip service provider. This warranty includes both parts and labor.

Extended Three (3) Year Limited Warranty - In addition to the Two (2) year Limited Warranty described above, the Zip Customer can opt to extend the Zip Product warranty by one (1) year, making the total Limited Warranty period three (3) years. In order to extend the warranty to three (3) years, the Zip Customer must register their product with Zip. This extended three (3)

Warranty

year Limited Warranty is subject to the same conditions as provided above in clauses a) and b).

How To Register?

Zip Products must be registered online at www.na.zipwater.com

What If Repair Is Impossible?

If Zip determines that the warranted repair of any Zip Product is impossible, the Zip Product shall, at Zip's discretion, either be replaced or refunded.

What Is Not Covered by This Limited Warranty?

This Limited Warranty does not cover:

- Damage or defects caused by, or resulting from, repairs, service, conversion or alterations to the Zip Product or any of its parts and accessories which have been performed by service centers or repairmen not authorized by Zip; damage or defects caused by negligence, improper installation (when not installed by an authorized Zip service provider), accident, abuse, misuse, power interruptions, power surges, unsuitable water conditions, floods, natural disasters, or force majeure; or improper maintenance of the Zip Product or its parts or accessories.
- Ordinary wear and tear.
- Consumable items such as water filter cartridges or CO2 cylinders.
- Zip Products covered by third party "Extended Warranties", which are sold separately by dealers, distributors or other third parties.
- Freight or shipping charges for sending a Zip Product to a Zip Repair Center.
- Products installed in cabinetry and other types of built-in applications that are not accessible to the service technician. We are not responsible for the dismantling or reinstallation of fixed infrastructure when removing or returning repaired or replaced Zip Product(s) into a custom installation.

Exclusion of Other Warranties

Any express or implied warranties with respect to the Zip Product are limited in their duration to the term of the Limited Warranty provided herein, including without limitation any warranty of merchantability or fitness for a particular purpose.

Limitation of Liability for Special, Incidental, Consequential Or Punitive Damages

ZIP SPECIFICALLY DISCLAIMS ANY AND ALL LIABILITY, WHETHER DIRECTLY OR INDIRECTLY, FOR ANY AND ALL SPECIAL, INCIDENTAL, CONSEQUENTIAL, PUNITIVE OR EXEMPLARY LOSS OR DAMAGE, INCLUDING AS A RESULT OF ANY DEFECT IN MATERIALS OR WORKMANSHIP (INCLUDING LOSS OR DAMAGE TO PROPERTY, PERSONAL INJURY OR DEATH), WHETHER BASED

Warranty

ON BREACH OF CONTRACT, TORT, STRICT OR PRODUCT LIABILITY, OR ANY OTHER LEGAL THEORY.

Dispute Resolution

If the Zip Customer is not satisfied with the warranty service, he or she must submit a claim in writing to Zip's Dispute Settlement Representative at Culligan International Company, d/b/a Zip Water, 9399 W Higgins Rd, Rosemont, IL 60018. The written notice must include the model and serial number of the Zip Product, the Authorized Zip Dealer (or seller) from which the Zip Product was purchased, the Authorized Zip Servicer Provider who performed the warranty service, the purchase date, a detailed description of the problem and the address and phone number at which the Zip Customer can be reached. Zip is committed to review each such notice promptly and thoroughly and to respond to the Zip Customer in order to settle such dispute. Any decision is not binding. Any controversy or claim arising out of Zip Customer's purchase of the Zip Product that cannot be settled amicably shall be settled by arbitration administered by the American Arbitration Association in accordance with its Commercial Arbitration Rules. The arbitration hearing shall take place in Chicago, IL before a single arbitrator. Judgment on the award rendered by the arbitrator may be entered in any court having jurisdiction thereof. If Zip prevails, Zip shall be entitled to reimbursement of all costs and expenses, including attorney's fees, from the Zip Customer.

How to Obtain Warranty Service for The Zip Product?

If during the relevant warranty period the Zip Customer finds the Zip Product to be defective in material or workmanship and the failure is promptly and timely reported to Zip in accordance with this Limited Warranty, an authorized Zip service agent shall be dispatched to determine whether the Zip Product is defective. If the authorized Zip service agent determines in his/her sole discretion that the Zip Product is (i) defective and (ii) covered by this Limited Warranty, the Zip service agent will either repair (if possible) or make arrangements for the repair of the Zip Product at no cost to you. This will include parts and labor. Zip reserves the right to charge for exceptional shipping or transportation costs (e.g., ferries, plane trips or excess mileage) as appropriate.

For service for all products under this Limited Warranty, or for product information, please contact Zip Service at service@na.zipwater.com or by calling 1-833-233-2358.

Effective Date: July 1, 2018,

Culligan International Company d/b/a Zip Water©2018 Zip Water. All Rights Reserved.



Manufactured by Zip Heaters (Aust) Pty Ltd

67 - 77 Allingham Street,
Condell Park NSW 2200
Australia

Distributed in US and Canada by: Culligan International Company

9399 West Higgins Road, Suite 1100
Rosemont, IL 60018
www.na.zipwater.com

Call US Toll Free 1-833-233-2358 for assistance, service, spare parts or enquiries.

As Zip policy is one of continuous product improvement, changes to specifications may be made without prior notice. Images in this booklet have been modified and may not be true representations of the finished goods.

The terms "Zip" and "HydroTap" are registered trade marks of Zip Heaters (Aust) Pty Ltd.

BCS60, BCS20, and BCS Home systems certified by IAPMO R&T against NSF/ANSI Standard 42, NSF/ANSI Standard 53, NSF/ANSI Standard 372, CSA B483.1, ASSE 1023, and ASSE 1087. This will deliver the required bacteriostatic effect and the reduction of aesthetic chlorine, taste, odor, nominal particulate Class I ($\geq 0.5 \mu\text{m}$ to $< 1 \mu\text{m}$), cyst and lead as verified and substantiated by test data. See Performance Data Sheets for specific performance claims.

BCS60 and BCS20 system certified performance claims only valid when filter cartridge 1.5Z-LS (Culligan Part Number 01034277) is used. BCS Home system certified performance claims only valid when filter cartridge 1Z-LS (Culligan Part Number 01034276) is used.

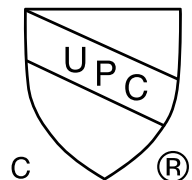

© 2021 Zip Heaters (Aust) Pty Ltd

Quick start installation guide

Zip HydroTap G5



HydroTap Clean: At installation cleaning



Australia



UK

Visit our website to
download the manuals

Table of contents

The HydroTap Clean process	2
SECTION 1: Using these instructions	3
SECTION 2: IMPORTANT SAFETY INSTRUCTIONS.....	4
SECTION 3: Technical data & parts supplied	5
SECTION 4: Commissioning	6
4. Commissioning the HydroTap using the HydroTap Clean can.....	6
4.1 Turn on the supplies & familiarize yourself with the system.....	6
4.2 Select the language	6
4.3 Install the filter cartridge	7
4.4 Set the date, time & drain away options	7
4.5 Filter flush	8
4.5.1 Limescale filter flush	9
4.6 System priming (BCS, BC, BA, CS, C models).....	10
4.7 Cleaning preparation (BCS, BC, BA, CS, C models).....	12
4.8 Boiling calibration and cleaning	14
4.9 Tank flush.....	18
4.10 Select the booster.....	21
Contact details	24

The HydroTap Clean process

HydroTap Clean is a first to market cleaning process for HydroTap systems comprised of the HydroTap Clean solution, dosing adaptor and smart firmware.

The HydroTap Clean process is automated and gently cleans the chilled and sparkling water paths during the commissioning of a new HydroTap Command Centre.

The HydroTap Clean solution is:

Safe, natural, certified organic, PH neutral, biodegradable solution produced by electrochemically activated water acting like a detergent.

HydroTap Clean is also non-corrosive to gently clean the chilled and sparkling internal water paths of your new HydroTap.

SECTION 1: Using these instructions

Before you start



This document details:

The HydroTap system commissioning process using the HydroTap Clean can.

For further details on installing and operating your HydroTap system download & read the Command Centre installation and user instructions , which can be found online at:

na.zipwater.com



Read and use the instructions supplied with individual kit components for a safe installation.

Explanation of symbols



Read the instructions



WARNING



Hot surface



Gas
WARNING

SECTION 2: IMPORTANT SAFETY INSTRUCTIONS



Compressed gas warning

- Read label before use.
- Keep out of reach of children.
- Use according to SDS (safety data sheet).
- Pressurised container. Contains gas under pressure, may explode if heated.
- Protect from sunlight.
- Do not expose to temperatures exceeding 50 °C.
- Do not expose to naked flame or any incandescent material.
- Do not pierce or burn, even after use.
- Avoid shock.
- SDS is available for download at www.zipwater.com or www.zipwater.co.uk

First aid

- For advice contact a Poison Control Information Centre
- Australia (+61) 131126
- France (+33) 3 8385 2192
- Germany (+49) 3018 4120
- Ireland (+353) 1809 2166
- New Zealand (+64) 0800 764 766
- UK (+44) 171 635 9191
- USA (+1) 1-800-222-1222

SECTION 3: Technical data & parts supplied

Parts supplied with the HydroTap Clean kit	Qty
HydroTap Clean can adapter (1) (used in filter head)	1
HydroTap Clean can (2)	1
HydroTap Clean instructions	1

Parts identification



WARNING ! Do not connect the parts together before carefully reading/following instructions.

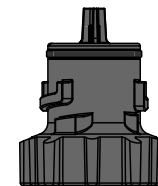

HydroTap Clean adapter (1)

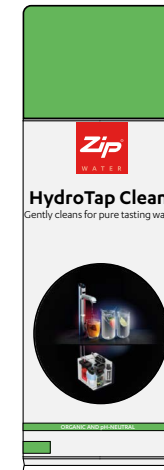

HydroTap Clean can (2)

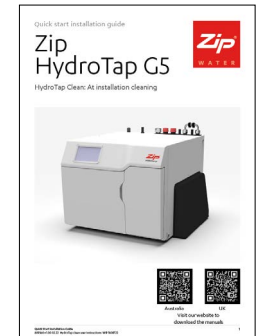

HydroTap Clean instructions

4. Commissioning the HydroTap using the HydroTap Clean can

4.1 Turn on the supplies & familiarize yourself with the system

- Connect the mains electrical power cable to the supply.
- Turn the power and water on and check for any leaks.
- Familiarize yourself with the operation of the tap and GUI screen in preparation for use, see the user guide.
- Initial commissioning screen touch Language option.

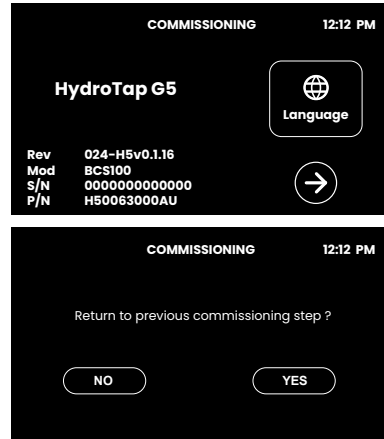

- Optional screen shown if the commissioning was previously started but not complete (Command Centre powered off during process). Otherwise screen will not be shown.

4.2 Select the language

- Touch the appropriate button to select the language and units of choice.
- Touch the back arrow to go back to previous menu.
- In the previous menu, touch the arrow to begin the commissioning process.
- Read the commissioning information, touch the forward arrow to go to the next screen.
- (Touch the back arrow to go back to previous menu).

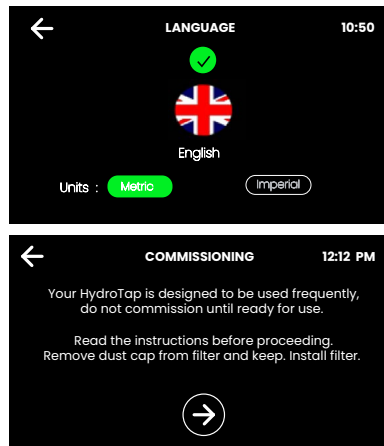

4.3 Install the filter cartridge

- Unpack filter cartridge.
- Remove dust cap and set aside in a clean area for use later.
- Write today's date where shown on the label.
- Avoid touching the filter o-rings and filter opening as this may cause bacterial contamination of the cartridge.
- Moisten the o-rings with water.
- Open the filter door on the Command Centre.
- Push the new cartridge up into the filter head.
- Turn the cartridge a quarter turn to the right until it comes to a complete stop and locks.

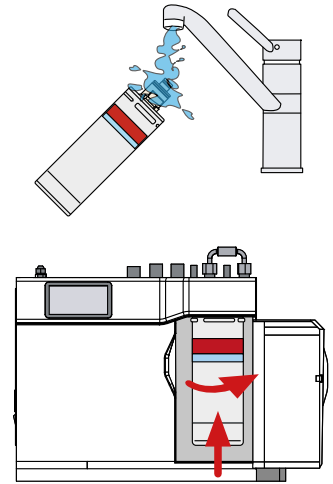

4.4 Set the date, time & drain away options

- Touch the date and time, use "-" or "+" to make adjustments. When ready, touch the arrow to continue.
- Select 'Sink / Container' or 'Drip Tray' depending on the model, see below.
- Select 'Font' if the HydroTap is mounted on a font.
- Select 'Sink / Container' if the HydroTap is mounted such that the waste water dispenses into a sink, or container.
- **Note** This selection will determine if water is dispensed automatically or requires operation of the tap during the tank flush process.
- Touch the arrow to continue.

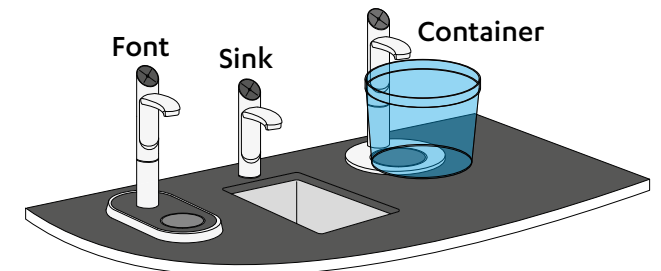
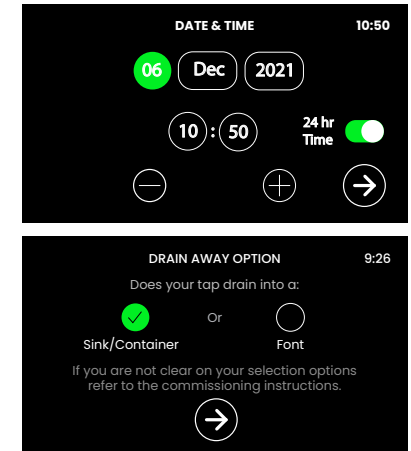

4.5 Filter flush

- Follow the steps on-screen to flush the filter.
- Open filter door & uncoil flush line.
- Direct flush line into bucket.
- Place a cloth or towel under the filter cartridge to catch any water that may spill.
- Open the shut-off valve.
- Start filter flush.

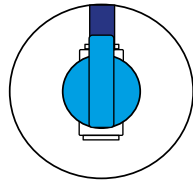
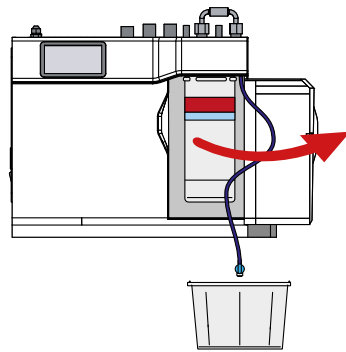

Shut-off valve open

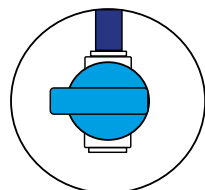
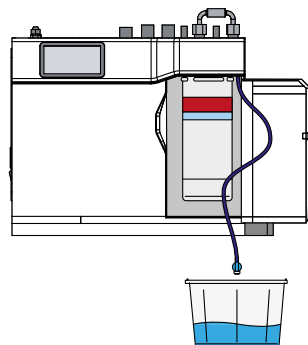

Shut-off valve closed

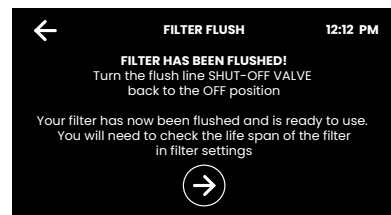
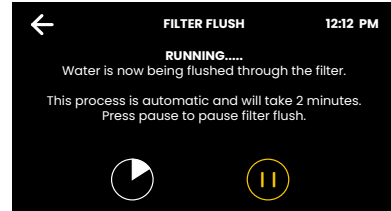
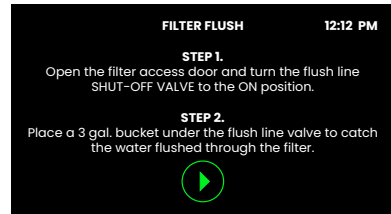

- Once the filter flush is finished, close the shut-off valve.
- Wipe up any spills.
- Close the door to secure the appliance.

4.5.1 Limescale filter flush (If optional limescale filter is installed)

- Follow the steps on-screen.
- (Selecting NO advances the screen to the next process).

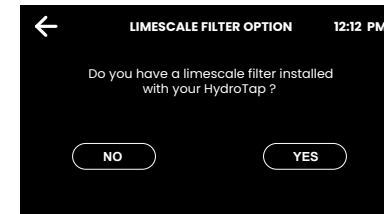

- Disconnect the limescale filter OUT hose from the Command Centre manifold.
- Direct it into a 15 litre container.
- Touch green play icon to start filter flush.

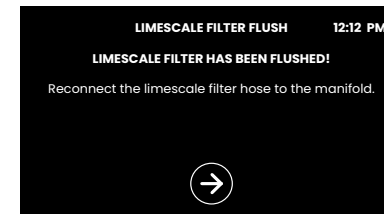
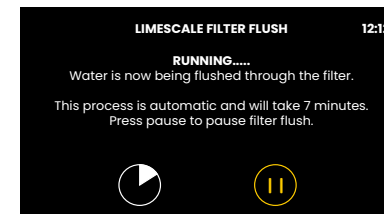
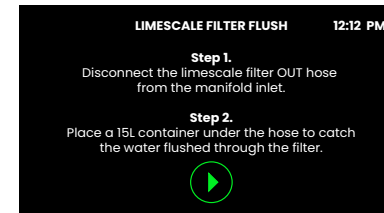

- Once the filter flush is finished, reconnect the limescale filter OUT hose to the Command Centre manifold.
- Touch the arrow to go to the next screen

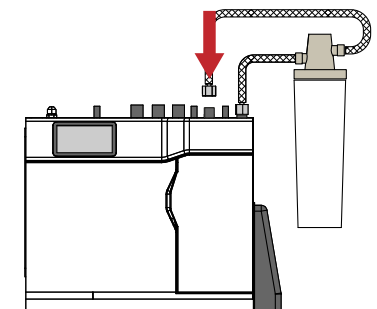
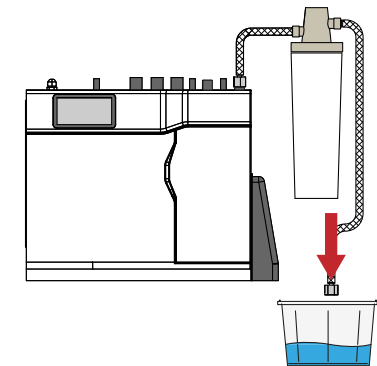
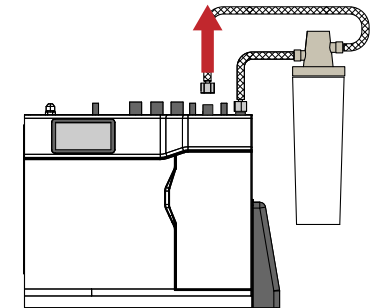

SECTION 4: Commissioning

4.6 System priming (BCS, BC, BA, CS, C models)

- Read the on screen information.
- For sparkling models disconnect the CO₂ bottle or turn off the CO₂ regulator (see the User guide).
- Confirm on screen.
- Touch the run arrow to go to the next screen.

BCS CS

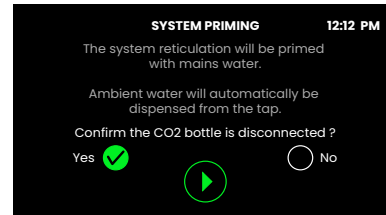

BC, BA, C

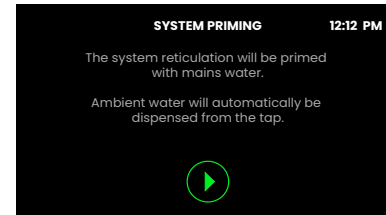

- Monitor the on screen information.

BC

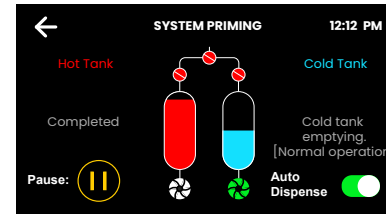

BCS

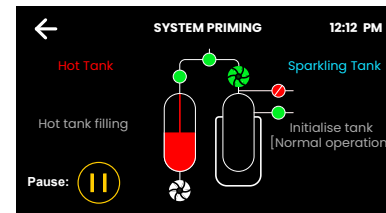

SECTION 4: Commissioning

BA

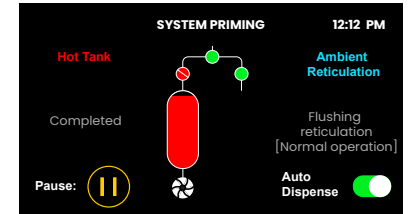

C

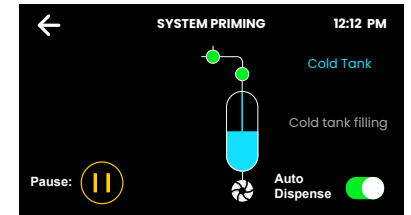

CS

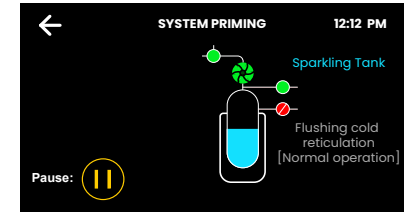

- **Note** if 'Font' has been selected on the drain away option (see section 4.4) and auto dispense is disabled on entry into this screen; the screen prompts the user to dispense using the tap during the process.

SECTION 4: Commissioning

4.7 Cleaning preparation (BCS, BC, BA, CS, C models)

- Read the on screen information.



- Place a cloth under the filter.
- Remove the filter, refit the dust cap, and set aside in a clean environment.

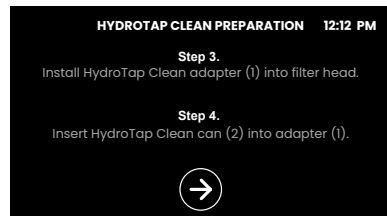
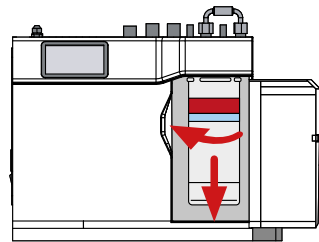

- Check the adapter seal is present and correctly positioned in the adapter.
- Install the HydroTap Clean adapter (1) into the filter head.
- Turn the adapter a quarter turn to the right until it comes to a stop and locks.

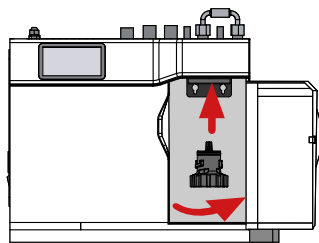
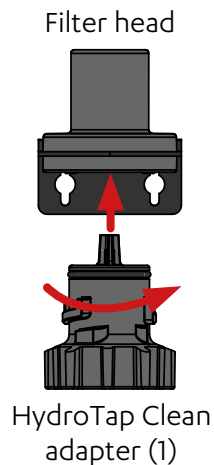

- Remove the lid from the HydroTap Clean can (2).



HydroTap Clean can (2)

- Screw the HydroTap Clean can (2) into the adapter (already installed into the filter head).

Filter head and HydroTap Clean adapter (1)



HydroTap Clean can (2)

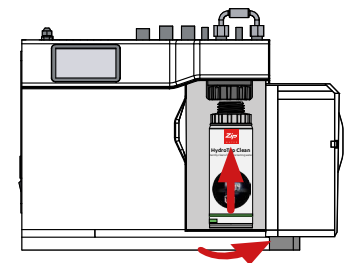

- Confirm installation of the HydroTap Clean can by selecting YES on the screen.



SECTION 4: Commissioning

4.8 Boiling calibration and cleaning

- Read the on screen information.
- This screen differs for different water types:
- B, just boiling calibration.
- C, CS, just cleaning.
- BC, BCS, BA, combined boiling calibration and cleaning.
- Touch the green arrow to run.

BCS, BC, BA

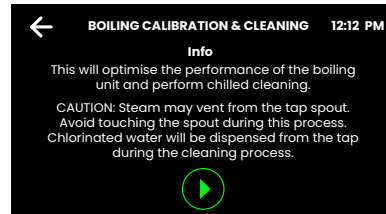

CS, C

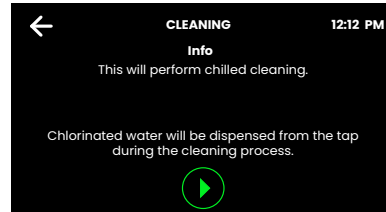

B

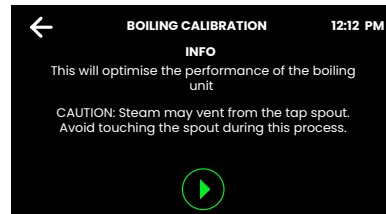

B

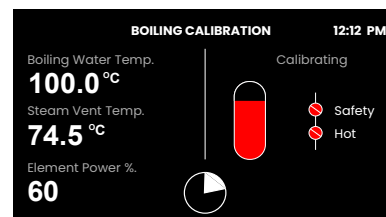

BCS, BC, BA

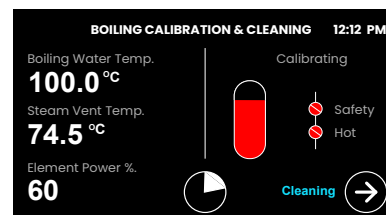

- Boiling calibration and cleaning process begins.
- Monitor the on screen information.
- Touch 'Cleaning' forward arrow to view screen of cleaning process.
- **Note** If 'Cleaning' text is flashing there is a required action on that screen to perform (empty cold tank).

SECTION 4: Commissioning

- Cleaning process begins.
- Monitor the on screen information.
- **Note** This is automatic unless 'Font' was selected in the drain away option selection screen (see section 4.4). In this case a manual dispense action may be requested.

BC,C

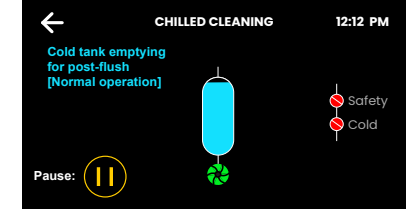
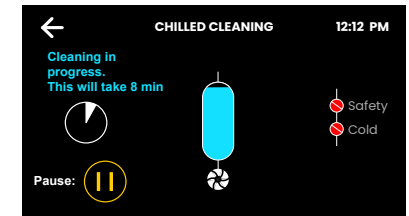

BCS, CS

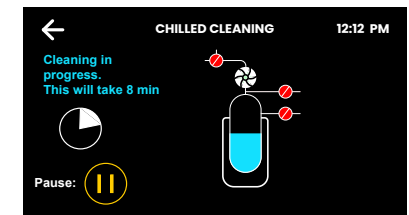
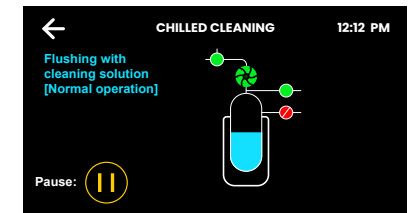

BA

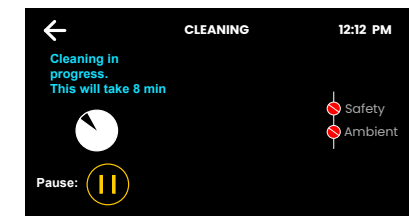
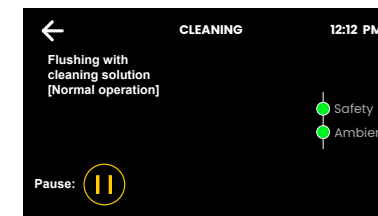

SECTION 4: Commissioning

- Read the on screen information and instructions.
- **Note** When the cleaning process completes there is an opportunity to re-install the filter while the boiling calibration is finishing.
- This screen is shown after completion of the boiling calibration and or cleaning processes.
- Unscrew the HydroTap Clean can (2).
- Ensure to hold the adapter in place while unscrewing the can.

BCS, BC, BA

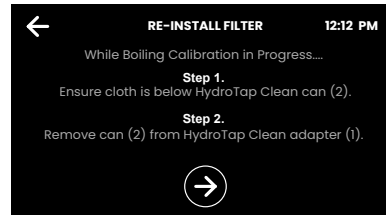

BCS, BC, BA, CS, C

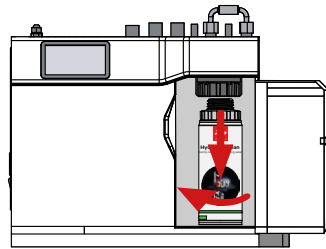
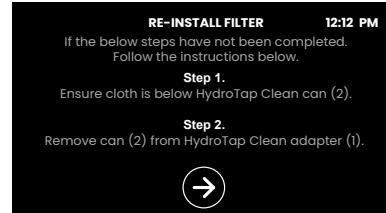

SECTION 4: Commissioning

BCS, BC, BA

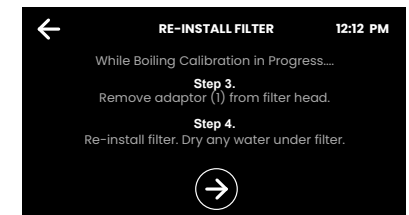

BCS, BC, BA, CS, C

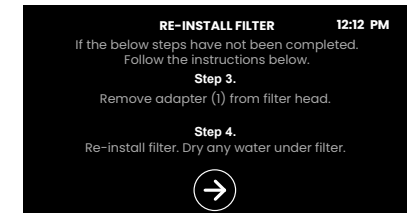

- Remove the HydroTap Clean adapter (1) from filter head.
- Remove the dust cap and re-install the filter.
- Touch forward arrow on screen to continue.

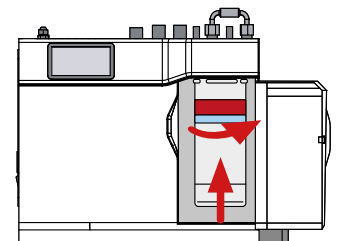
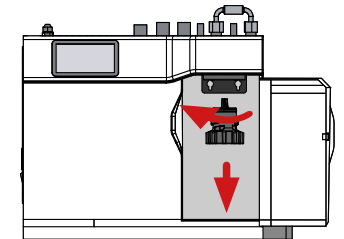

SECTION 4: Commissioning

4.9 Tank flush

- Read the on screen information and instructions.
- Touch the green arrow to run.
- Empty the hot tank first (boiling models).
- Select NO if it is not safe to continue.
- Select YES to continue safely.
- If NO is selected (indicating that it is not safe to continue) the screen will prompt the user to clear the sink area.
- Once it is safe to continue select YES to empty the hot tank.
- There are two ways to empty the hot tank:
 - Dispense boiling water from the tap using the tap safety feature.
 - OR
 - Touch and **HOLD** the green run arrow icon to dispense directly from the touch screen display.
 - If choosing to dispense directly from the touch screen display, 'dispensing boiling water' text flashes on the screen while holding the button.
 - After the boiling tank is emptied the system progresses to the tank flush screen.
- **Note** For all models, the on screen cycle counter displays the number of remaining cycles in the tank flush process.

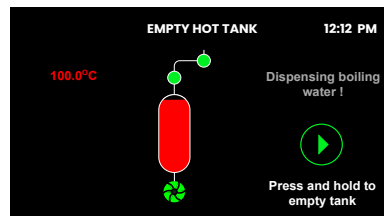
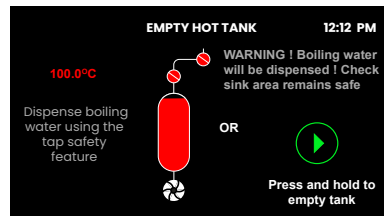
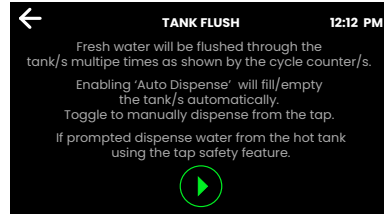

SECTION 4: Commissioning

- Monitor the on screen information.
- For BCS models:
 - The hot tank will cycle twice.
 - The sparkling tank will cycle once on both the chilled and sparkling reticulation.
- **Note** For all boiling models, if after filling the hot tank during the tank flush process, the hot water temperature is still above 50°C the tank will need to be emptied again.
- Monitor the on screen information.
- For BC models :
 - The hot tank will cycle twice.
 - The cold tank will cycle three times.
- Monitor the on screen information.
- For BA models the hot tank will cycle twice.
- The ambient water will be flushed for 30 seconds.
- Monitor the on screen information.
- For B models the hot tank will cycle twice.

BCS

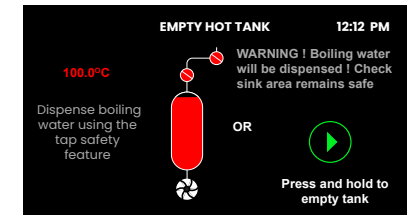
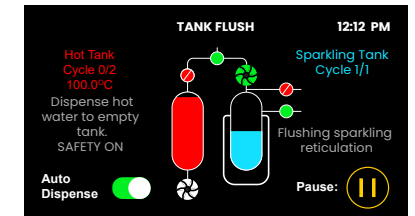

BC

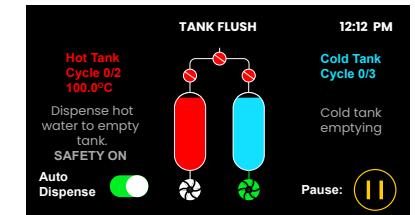

BA

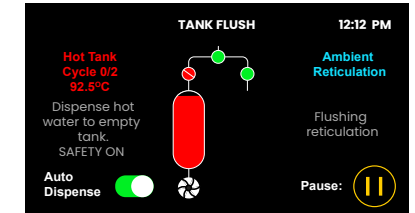

B

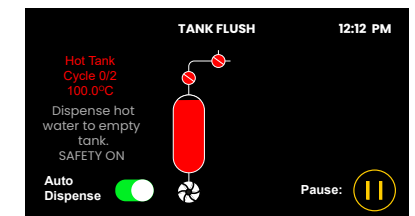

SECTION 4: Commissioning

CS

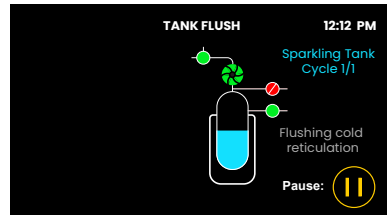

C

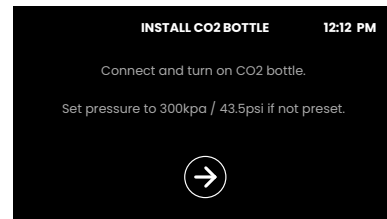
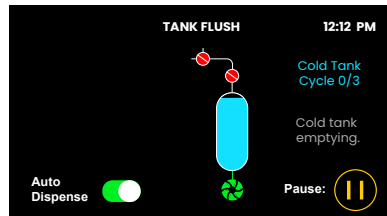

BCS, CS

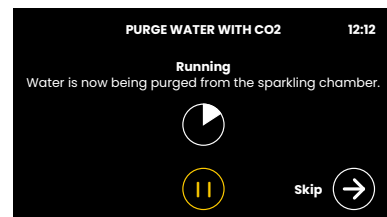
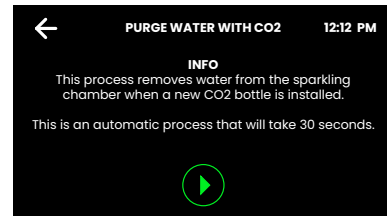

- Monitor the on screen information.
- For CS models the sparkling tank will cycle once on both the chilled and sparkling reticulation.

- Monitor the on screen information.
- For C models the cold tank will cycle three times.

- For BCS, CS models:
- Read the on screen information.
- Ensure that the CO₂ cylinder is connected and if supplied with an adjustable regulator, set to 3.0 bar (300kPa).

- Touch the green arrow to run.
- CO₂ life settings should be adjusted for the size of the CO₂ bottle connected. (see the User guide or Online Installation and User guide.

- Use the skip arrow to end the CO₂ purge process prematurely if all water has been purged and only gas can be heard coming from the tap.

SECTION 4: Commissioning

4.10 Select the booster

- Read the on screen instructions.
- Select the appropriate option.
- BCS, BC, BA, B: 100 & 30 models select Booster installed.
- All other models, Booster not installed.

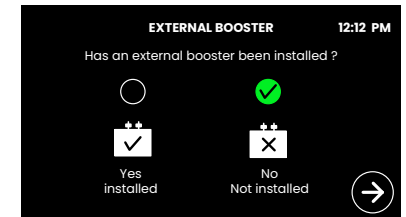

Notes

Notes

Contact details



Manufactured by Zip Heaters (Aust) Pty Ltd

67 - 77 Allingham Street,
Condell Park NSW 2200
Australia

Distributed in US and Canada by: Culligan International Company

9399 West Higgins Road, Suite 1100
Rosemont, IL 60018
www.na.zipwater.com

Call US Toll Free 1-833-233-2358 for assistance, service, spare parts or enquiries.

As Zip policy is one of continuous product improvement, changes to specifications may be made without prior notice. Images in this booklet have been modified and may not be true representations of the finished goods.

The terms "Zip" and "HydroTap" are registered trade marks of Zip Heaters.

Installation instructions



Zip HydroTap G5

Faucets - Arc & Cube



Table of contents

SECTION 1: Using these instructions	2
1.1 Using these instructions.....	2
SECTION 2: Performance data & regulatory standards	3
SECTION 3: Generic installation requirements	4
3.1 Tools needed for faucet installation	4
SECTION 4: Installation - Arc & Cube	4
4.1 Positioning	4
4.2 Select height & spout position	5
4.3 Set up the height and spout position	5
4.4 Cut the hole	6
4.5 Mount the faucet.....	6
4.6 Fit the tube kit	6
4.7 Secure the tube kit & fit the label.....	7
4.8 Command Centre connections.....	7
SECTION 5: Cleaning and maintenance	7
5.1 Cleaning.....	7

SECTION 1: Using these instructions

1.1 Using these instructions

Please refer to all safety and installation requirements detailed in the Quick start guide provided with the HydroTap Command Centre, and HydroTap Command Centre installation instructions found online, prior to installation of, or any change to, the complete system.



WARNING



**Read the
instructions**

**Before commencing the installation, download
& read the HydroTap Command Centre
installation instructions**

SECTION 2: Performance data & regulatory standards

- The ARC XX and Cube XX faucets have been certified by IAPMO R&T against NSF/ANSI Standard 42, NSF/ANSI Standard 53, NSF/ANSI Standard 372, CSA B483.1, ASSE 1087, and ASSE 1023 when used as part of the BCS60, BCS20, BCS Home, BC40, and BC Home systems.
-
- The ARC XX and CUBE XX faucets have been certified by IAPMO R&T against NSF/ANSI Standard 42, NSF/ANSI Standard 53, NSF/ANSI Standard 372, CSA B483.1, and ASSE 1087 when used as part of the CS100 and CS Home systems.
-
- XX = Chrome, Brushed Chrome, Matte Black, Rose Gold, Nickel, Brushed Nickel, Gunmetal Gray, Brushed Gold faucet finish options.

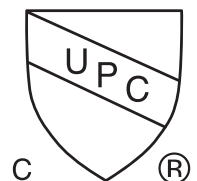

SECTION 3: Generic installation requirements

3.1 Tools needed for faucet installation

In addition to normal tools, the following (or equivalent equipment) will be required, (not supplied).

- 1 3/8", (35mm) diameter sheet metal hole punch for sinks.
- 1 3/8", (35mm) diameter hole saw for worktops.
- Tube spanner for fixing the tap assembly.



**Be aware of the risks of hazards which could cause harm when using tools.
Assess the risks before starting the installation.**

SECTION 4: Installation - Arc & Cube

4.1 Positioning

Position the faucet such that it dispenses into the sink bowl with clearance for a cup or tea pot.



Ensure that faucets are positioned to minimise the risks of scalding by dispensing boiling water while using the HydroTap.

Position Command Centre and faucet as close together as possible. See below.

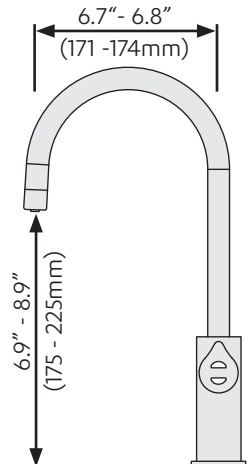
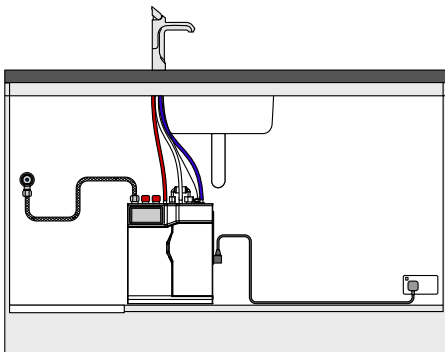

4.2 Select height & spout position

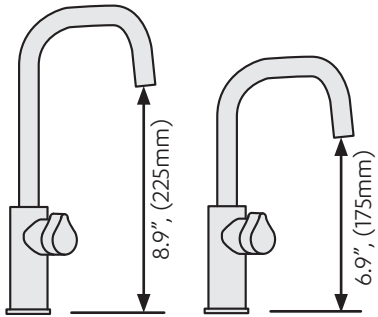

2 fixed height options



* see 4.1

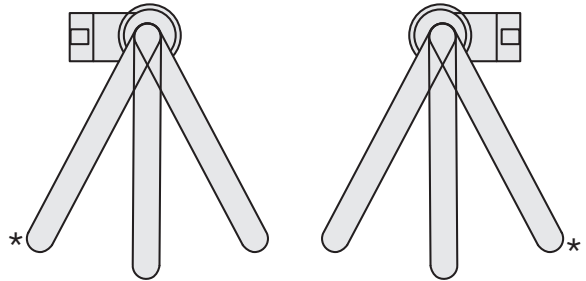

6 fixed position options

4.3 Set up the height and spout position

- Remove spout locating screws, lower spout to expose the spring clip.
- To reposition spout, prise open spring clip.
- Slide spring clip up/down to engage selected holes.
- Ensure dimples engage simultaneously with the two selected holes.
- Raise the spout (ensure USB lead fits in undercut and open ends of the clip).
- Align clip with locating holes, & refit the 2 x locating screws.

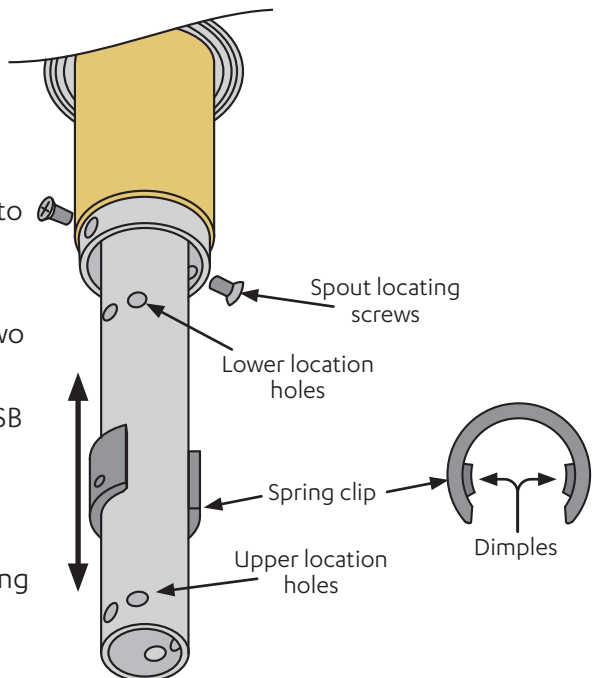

SECTION 4: Installation - Arc & Cube

4.4 Cut the hole

- Cut a $1\frac{3}{8}$ " (35mm) hole in the worktop / sink.
- Make sure the faucet location will allow the spout to drain into the sink.



4.5 Mount the faucet

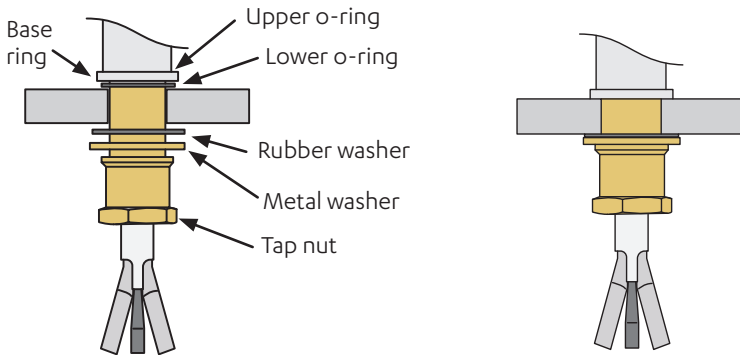

4.6 Fit the tube kit

vent connector must be fitted

Boiling, chilled sparkling

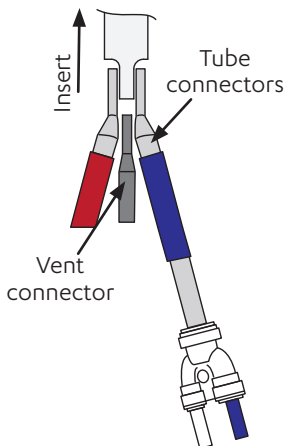

Boiling chilled

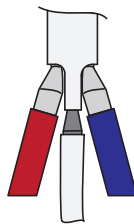

Chilled sparkling

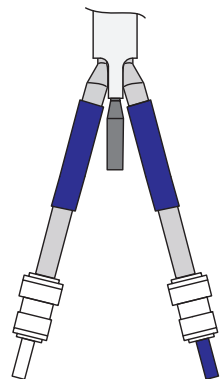

SECTION 4: Installation - Arc & Cube

4.7 Secure the tube kit & fit the label

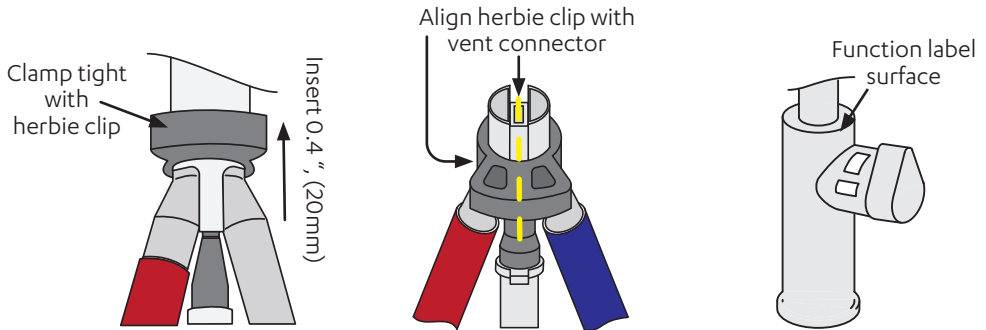

4.8 Command Centre connections

USB	Connected to the faucet.
Boiling out	Red silicone tube from faucet. Cut to length.
Chilled out	(BC) Blue silicone tube from faucet, (BCS, CS) Blue JG pipe from faucet. Cut to length.
Vent	Clear silicone tube from faucet. Cut to length.
Sparkling out	White JG pipe from faucet. Cut to length.

SECTION 5: Cleaning and maintenance

5.1 Cleaning

- Wipe surfaces with a damp cloth and then wipe dry with a clean, dry cloth.



IMPORTANT!

- Do not use air-drying disinfectant sprays.
- This could cause permanent malfunction and void warranty.



Manufactured by Zip Water (Australia) Pty Ltd

67 - 77 Allingham Street,
Condell Park NSW 2200
Australia

Distributed in US and Canada by: Culligan International Company

9399 West Higgins Road, Suite 1100
Rosemont, IL 60018
www.us.zipwater.com

Call US Toll Free 1-833-233-2358 for assistance, service, spare parts or enquiries.

As Zip policy is one of continuous product improvement, changes to specifications may be made without prior notice. Images in this booklet have been modified and may not be true representations of the finished goods.

The terms “Zip” and “HydroTap” are registered trade marks of Zip Water (Aust) Pty Ltd.

The ARC XX and CUBE XX faucets have been certified by IAPMO R&T against NSF/ANSI Standard 42, NSF/ANSI Standard 53, NSF/ANSI Standard 372, CSA B483.1, ASSE 1087, and ASSE 1023 when used as part of the BCS60, BCS20, BCS Home, BC40, and BC Home systems. See Performance Data Sheets for specific performance claims.

The ARC XX and CUBE XX faucets have been certified by IAPMO R&T against NSF/ANSI Standard 42, NSF/ANSI Standard 53, NSF/ANSI Standard 372, CSA B483.1, and ASSE 1087 when used as part of the CS100 and CS Home systems. See Performance Data Sheets for specific performance claims.

XX = Chrome, Brushed Chrome, Matte Black, Rose Gold, Nickel, Brushed Nickel, Gunmetal Gray, Brushed Gold faucet finish options.

© 2021 Zip Water (Aust) Pty Ltd

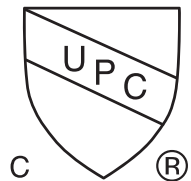

Installation instructions



Zip HydroTap G5

Faucets - Touch Free Wave, Elite Plus, Classic Plus, Classic



English



French

Visit our website to
download the manuals

Table of contents

SECTION 1: Using these instructions	2
1.1 Using these instructions.....	2
SECTION 2: Performance data & regulatory standards	3
SECTION 3: Generic installation requirements	4
3.1 Tools needed for faucet installation	4
SECTION 4: Installation - Wave, Elite, Classic Plus, Classic	5
4.1 Positioning	5
4.2 Cut the hole & fit the spacer	5
4.3 Mount the faucet.....	6
4.4 Secure the faucet.....	6
4.5 Familiarize yourself with the faucet connections	6
4.6 Command Centre connections for the Wave, Elite, Classic Plus, Classic.....	7
SECTION 5: Cleaning and maintenance	7
5.1 Cleaning.....	7

SECTION 1: Using these instructions

1.1 Using these instructions

Please refer to all safety and installation requirements detailed in the Quick start guide provided with the HydroTap Command Centre, and HydroTap Command Centre installation instructions found online, prior to installation of, or any change to, the complete system.



WARNING



**Read the
instructions**

**Before commencing the installation, download
& read the HydroTap Command Centre
installation instructions**

SECTION 2: Performance data & regulatory standards

- The Wave XX, Classic XX, Classic Plus XX, and Elite Plus XX faucets have been certified by IAPMO R&T against NSF/ANSI Standard 42, NSF/ANSI Standard 53, NSF/ANSI Standard 372, CSA B483.1, ASSE 1087, and ASSE 1023 when used as part of the BCS60, BCS20, BCS Home, BC40, and BC Home systems.
-
- The Wave XX, Classic XX, Classic Plus XX, and Elite Plus XX faucets have been certified by IAPMO R&T against NSF/ANSI Standard 42, NSF/ANSI Standard 53, NSF/ANSI Standard 372, CSA B483.1, and ASSE 1087 when used as part of the CS100 and CS Home systems.
-
- XX = Chrome, Brushed Chrome, Matte Black, Rose Gold, Nickel, Brushed Nickel, Gunmetal Gray, Brushed Gold faucet finish options.

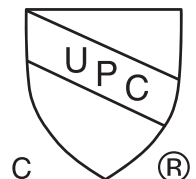

SECTION 3: Generic installation requirements

3.1 Tools needed for faucet installation

In addition to normal tools, the following (or equivalent equipment) will be required, (not supplied).

- 1 3/8", (35mm) diameter sheet metal hole punch for sinks.
- 1 3/8", (35mm) diameter hole saw for worktops.
- Tube spanner for fixing the tap assembly (supplied).



Be aware of the risks of hazards which could cause harm when using tools.

Assess the risks before starting the installation.

SECTION 4: Installation - Wave, Elite, Classic Plus, Classic

4.1 Positioning

- Position the faucet such that it dispenses into the sink bowl with clearance for a cup or tea pot.
- Observe 3.9", (100mm), 360° clearance envelope for Wave only.
- Wave will not operate in temperatures under 50°F, (10°C).

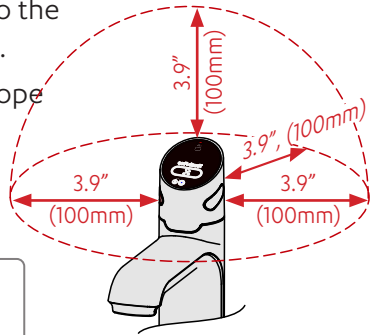

Wave clearance



Ensure that faucets are positioned to minimise the risks of scalding by dispensing boiling water while using the tap.

Position Command Centre and faucet as close together as possible. See below.

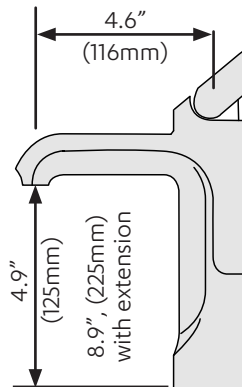
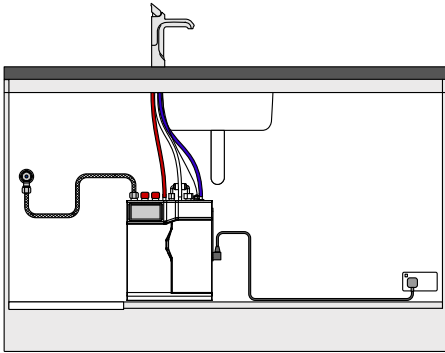

4.2 Cut the hole & fit the spacer

- Cut a 1 3/8", (35mm) hole in the worktop / sink.
- Apply a light smearing of silicone sealant on the underside of the spacer to ensure a watertight fit.

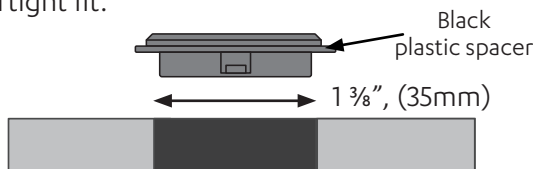

SECTION 4: Installation - Wave, Elite, Classic Plus, Classic

4.3 Mount the faucet

- Pass the tubes and USB cable through the 1 3/8", (35mm) hole.

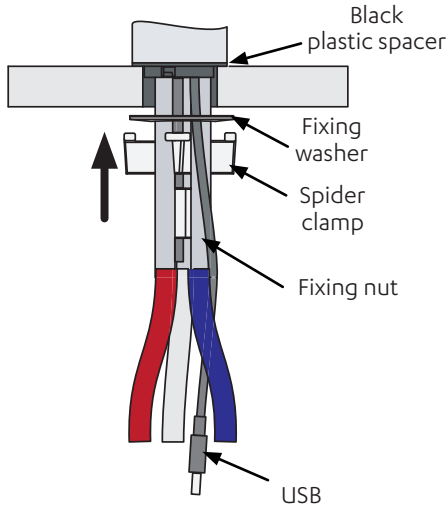

4.4 Secure the faucet

- Use a tube spanner to secure the tap in place.

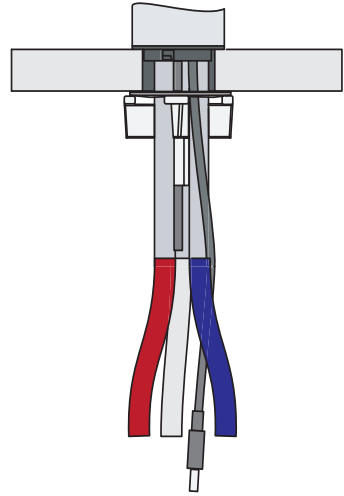

4.5 Familiarize yourself with the faucet connections

Boiling chilled

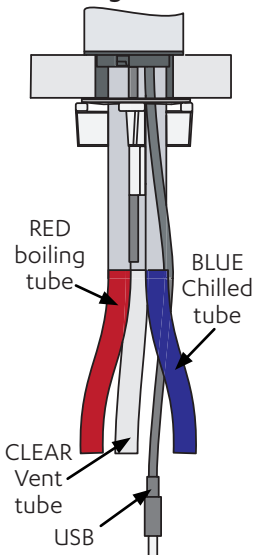

Chilled sparkling

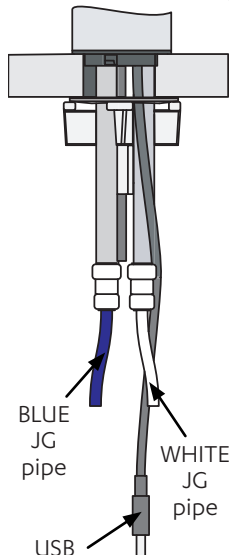

Boiling chilled sparkling

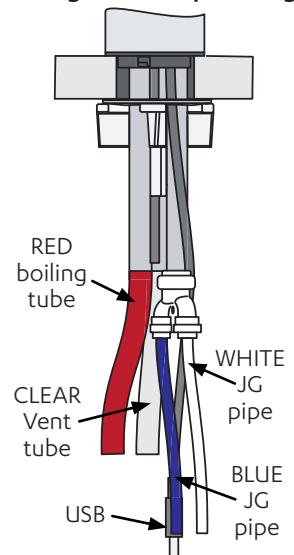

Installation instructions

Zip HydroTap G5

Faucets - Celsius All-in-One Arc



English



French

Visit our website to
download the manuals

Table of contents

SECTION 1: Using these instructions	2
1.1 Using these instructions.....	2
SECTION 2: Performance data & regulatory standards	3
SECTION 3: Generic installation requirements	4
3.1 Tools needed for faucet installation	4
SECTION 4: Installation - All-in-One Celsius Arc.....	5
4.1 Positioning	5
4.2 Cut the hole	5
4.3 Familiarize yourself with the mains connections	6
4.4 Familiarize yourself with the faucet connections	7
4.5 Mount and secure the faucet.....	8
4.6 Connect the water supply	9
4.7 Be careful with the sparkling pipework	10
4.8 Command Center connections for the All-in-One Celsius Arc.....	10
SECTION 5: Cleaning and maintenance	11
5.1 Cleaning.....	11

SECTION 1: Using these instructions

1.1 Using these instructions

Please refer to all safety and installation requirements detailed in the Quick start guide provided with the HydroTap Command Center, and HydroTap Command Center installation instructions found online, prior to installation of, or any change to, the complete system.



WARNING



**Read the
instructions**

**Before commencing the installation, download
& read the HydroTap Command Center
installation instructions**

SECTION 2: Performance data & regulatory standards

- The Celsius AIO faucet has been certified by IAPMO R&T against NSF/ANSI Standard 42, NSF/ANSI Standard 53, NSF/ANSI Standard 372, CSA B483.1, ASSE 1087, ASSE 1023, and ASME A112.18.1/CSA B125.1 when used as part of the BCS60, BCS20, and BCS Home systems.
-
- XX = Chrome, Brushed Chrome, Matte Black, Rose Gold, Nickel, Brushed Nickel, Gunmetal Gray, Brushed Gold faucet finish options.

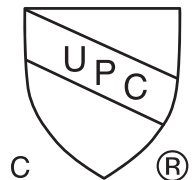

SECTION 3: Generic installation requirements

3.1 Tools needed for faucet installation

In addition to normal tools, the following (or equivalent equipment) will be required, (not supplied).

- 2", (50mm) diameter sheet metal hole punch for sinks.
- 2", (50mm) diameter hole saw for worktops.
- Tube spanner for fixing the tap assembly.



Be aware of the risks of hazards which could cause harm when using tools.

Assess the risks before starting the installation.

SECTION 4: Installation - All-in-One Celsius Arc

4.1 Positioning

Position the faucet such that it dispenses into the sink bowl with clearance for a cup or tea pot.



Ensure that faucets are positioned to minimise the risks of scalding by dispensing boiling water while using the faucet.

Position Command Center and faucet as close together as possible. See below.

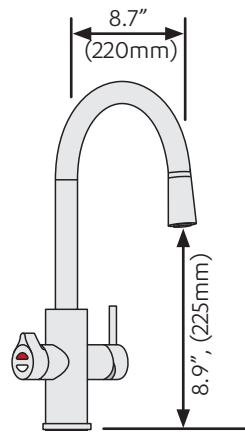
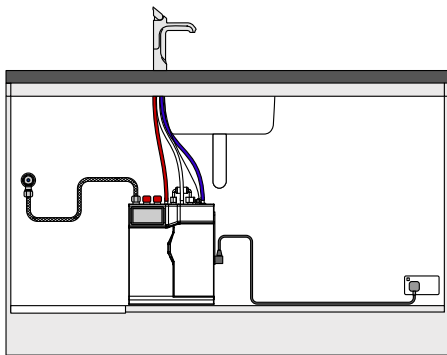

4.2 Cut the hole

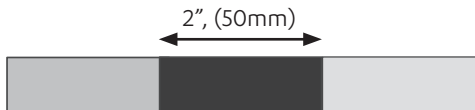

- Cut a 2", (50mm) hole in the worktop / sink.
- Make sure the faucet location will allow the spout to drain into the sink.

4.3 Familiarize yourself with the mains connections

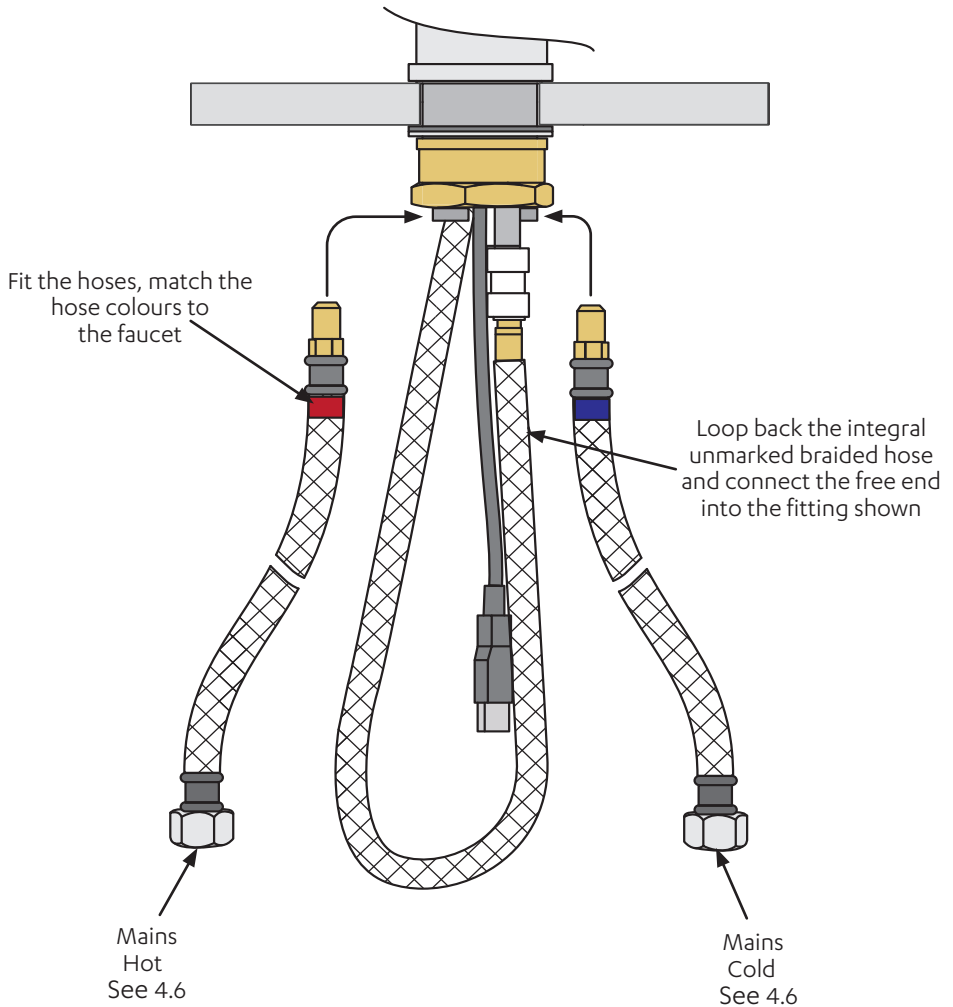

4.4 Familiarize yourself with the faucet connections

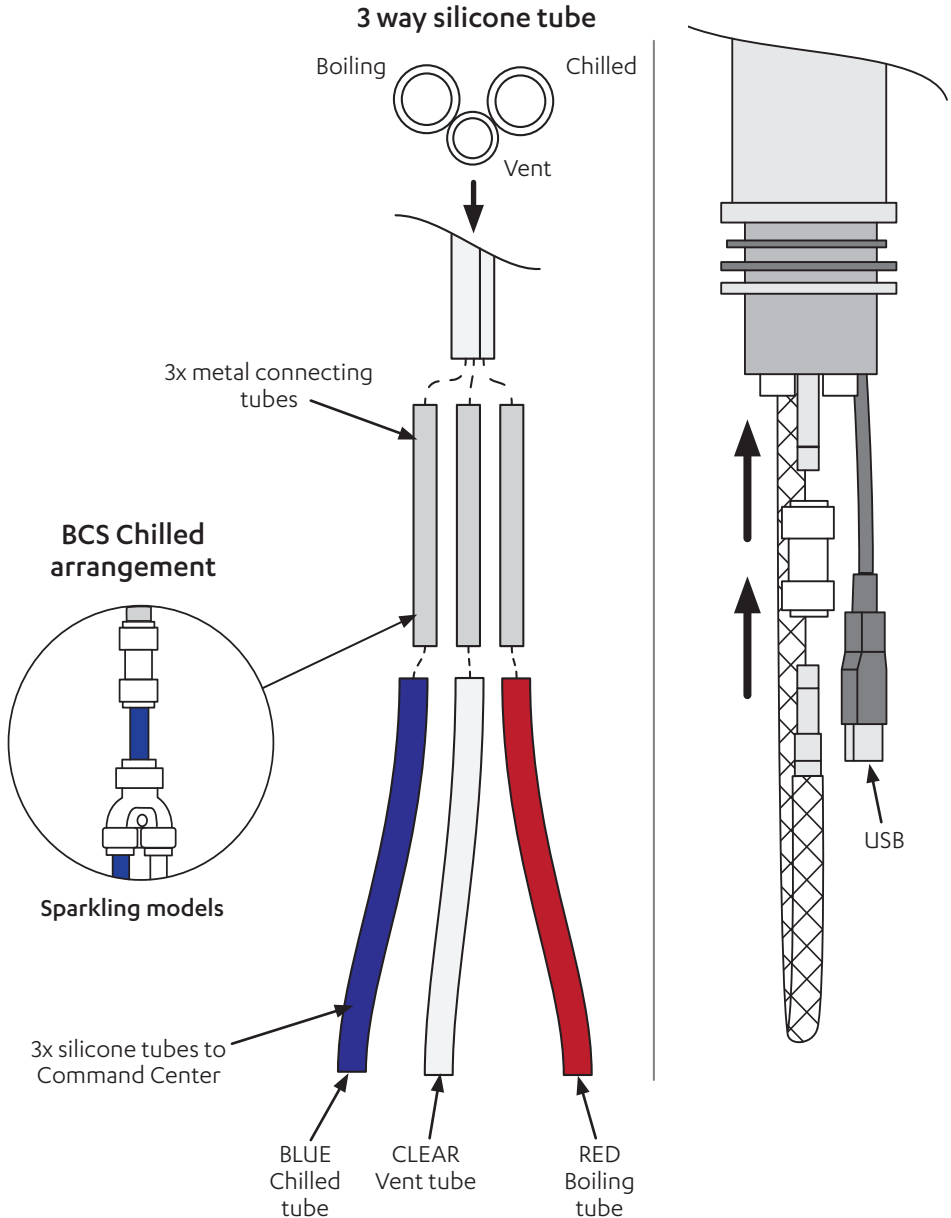

4.5 Mount and secure the faucet

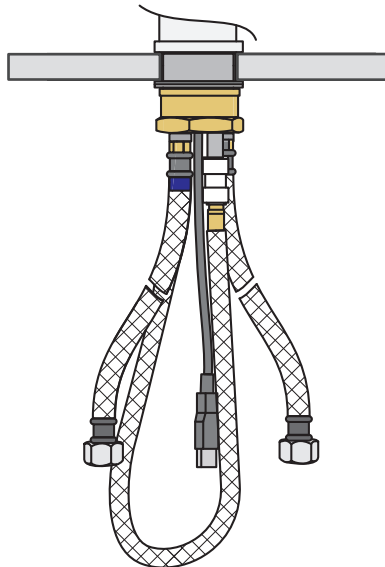
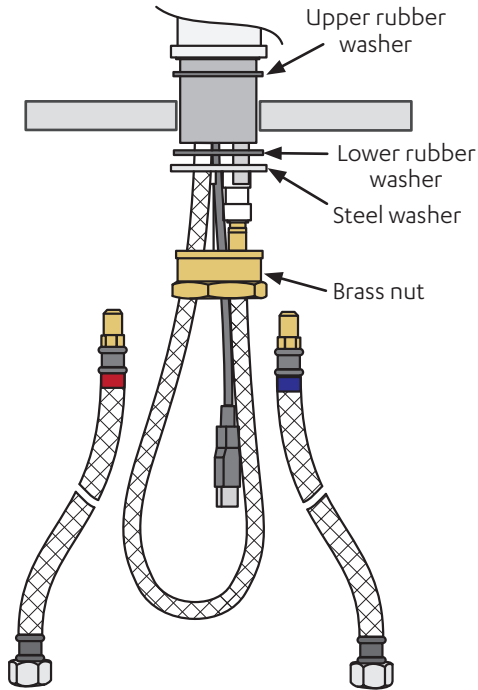

4.6 Connect the water supply

All fittings are supplied apart from the isolation valve.



Valves and fittings must be sealed with PTFE tape

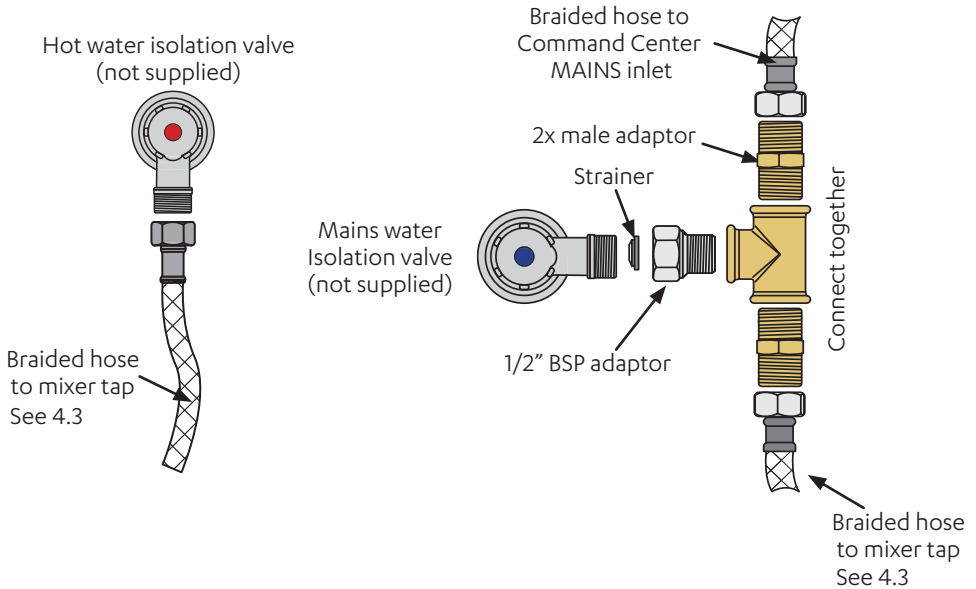

4.7 Be careful with the sparking pipework

- Silicone tubes are soft and easily deformed. It is essential to avoid kinks, loops and sags.
- Loosely cable-tie the rigid sparking pipework to an adjacent braided hose to avoid kinks and squeezing.

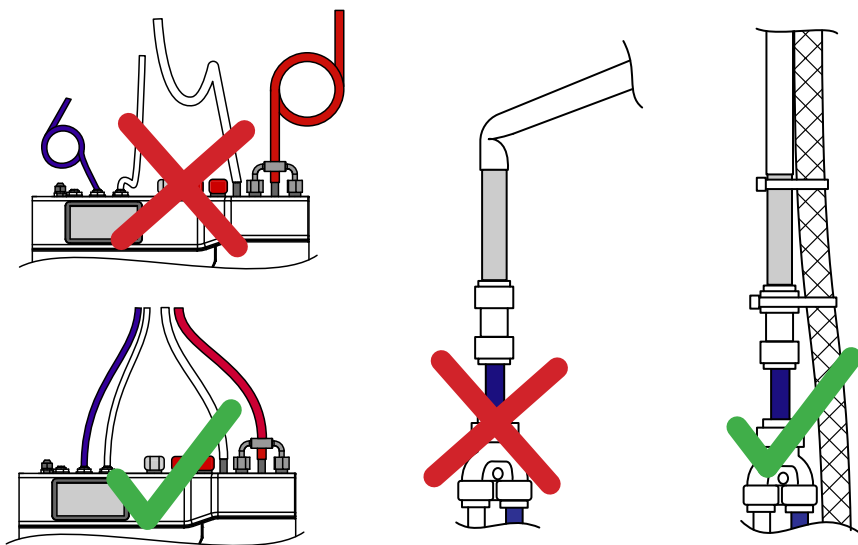

4.8 Command Center connections for the All-in-One Celsius Arc

Mains In	Mains potable water supply.
USB	Connected the faucet.
Boiling out	Red silicone tube from faucet. Cut to length.
Chilled out	(BCS) Blue JG pipe from faucet. Cut to length. (BC) Blue silicone tube from faucet. Cut to length.
Vent	Clear silicone tube from faucet. Cut to length.
Sparkling out	White JG pipe from faucet. Cut to length.

5.1 Cleaning

- Wipe surfaces with a damp cloth and then wipe dry with a clean, dry cloth.



IMPORTANT!

- Do not use air-drying disinfectant sprays.
- This could cause permanent malfunction and void warranty.



Manufactured by Zip Heaters (Australia) Pty Ltd

67 - 77 Allingham Street,
Condell Park NSW 2200
Australia

Distributed in US and Canada by: Culligan International Company

9399 West Higgins Road, Suite 1100
Rosemont, IL 60018
www.na.zipwater.com

Call US Toll Free 1-833-233-2358 for assistance, service, spare parts or enquiries.

As Zip policy is one of continuous product improvement, changes to specifications may be made without prior notice. Images in this booklet have been modified and may not be true representations of the finished goods.

The terms "Zip" and "HydroTap" are registered trade marks of Zip Heaters (Aust) Pty Ltd.

The Celsius AIO faucet has been certified by IAPMO R&T against NSF/ANSI Standard 42, NSF/ANSI Standard 53, NSF/ANSI Standard 372, CSA B483.1, ASSE 1087, ASSE 1023, and ASME A112.18.1/CSA B125.1 when used as part of the BCS60, BCS20, and BCS Home systems.

XX = Chrome, Brushed Chrome, Matte Black, Rose Gold, Nickel, Brushed Nickel, Gunmetal Gray, Brushed Gold faucet finish options.

© 2021 Zip Heaters (Aust) Pty Ltd

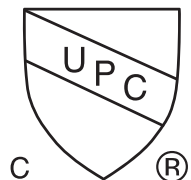

SECTION 4: Installation - Wave, Elite, Classic Plus, Classic

4.6 Command Centre connections for the Wave, Elite, Classic Plus, Classic

USB	Connected to the faucet.
Boiling out	Red silicone tube from faucet. Cut to length.
Chilled out	(BC) Blue silicone tube from faucet, (BCS, CS) Blue JG pipe from faucet. Cut to length.
Vent	Clear silicone tube from faucet. Cut to length.
Sparkling out	White JG pipe from faucet. Cut to length.

SECTION 5: Cleaning and maintenance

5.1 Cleaning

- Wipe surfaces with a damp cloth and then wipe dry with a clean, dry cloth.



IMPORTANT!

- Do not use air-drying disinfectant sprays.
- Do not use abrasives to clean the sensor lenses at the sides, top and rear of the Touch-Free Wave.
- This could cause permanent malfunction and void warranty.



Manufactured by Zip Heaters (Australia) Pty Ltd

67 - 77 Allingham Street,
Condell Park NSW 2200
Australia

Distributed in US and Canada by: Culligan International Company

9399 West Higgins Road, Suite 1100
Rosemont, IL 60018
www.na.zipwater.com

Call US Toll Free 1-833-233-2358 for assistance, service, spare parts or enquiries.

As Zip policy is one of continuous product improvement, changes to specifications may be made without prior notice. Images in this booklet have been modified and may not be true representations of the finished goods.

The terms "Zip" and "HydroTap" are registered trade marks of Zip Heaters (Aust) Pty Ltd.

The Wave XX, Classic XX, Classic Plus XX, and Elite Plus XX faucets have been certified by IAPMO R&T against NSF/ANSI Standard 42, NSF/ANSI Standard 53, NSF/ANSI Standard 372, CSA B483.1, ASSE 1087, and ASSE 1023 when used as part of the BCS60, BCS20, BCS Home, BC40, and BC Home systems.

The Wave XX, Classic XX, Classic Plus XX, and Elite Plus XX faucets have been certified by IAPMO R&T against NSF/ANSI Standard 42, NSF/ANSI Standard 53, NSF/ANSI Standard 372, CSA B483.1, and ASSE 1087 when used as part of the CS100 and CS Home systems.

XX = Chrome, Brushed Chrome, Matte Black, Rose Gold, Nickel, Brushed Nickel, Gunmetal Gray, Brushed Gold faucet finish options.

© 2021 Zip Heaters (Aust) Pty Ltd

