

FRONT FACE

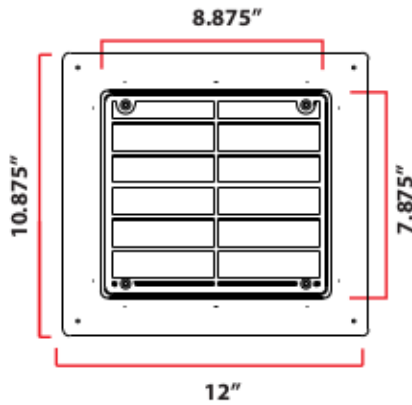

TOP VIEW

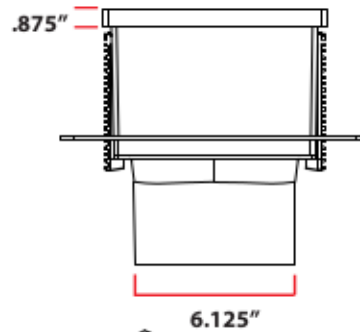

REAR VIEW

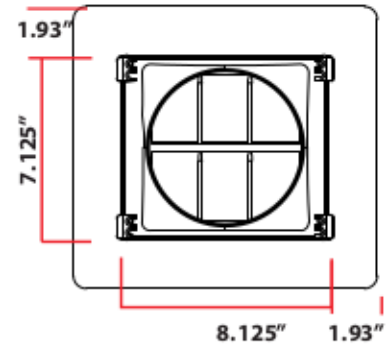

SECTIONAL VIEW

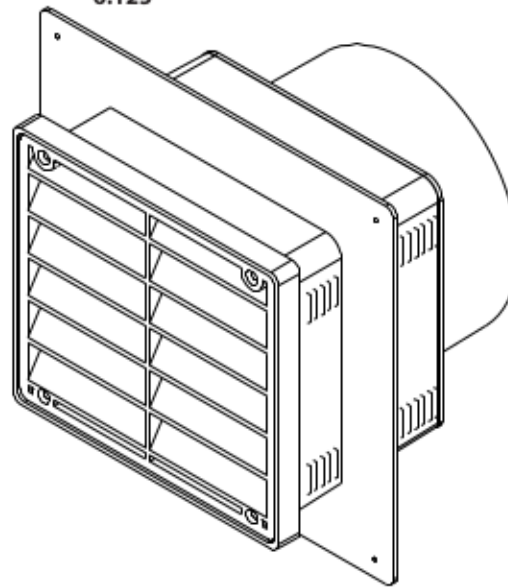
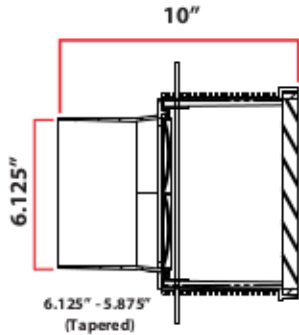

## MODEL # 6SEB-BR PERFORMANCE DATA

### FOR USE

- Bathroom exhaust
- Dryer exhaust
- Kitchen hood exhaust
- Fresh air make-up
- Devices that require exterior exhaust or intake

### MATERIALS

- Constructed from high temperature plastic polymers.
- Material tested for use on high temperature appliance devices or components. (max sustainable operational temperature at 235°)
- ASTM E84 / UL723 flame spread rating.
- All materials made and fully assembled in the USA

## GENERAL INFORMATION

### BENEFITS

- Prevents exterior air from entering interior area
- Prevents mold & mildew\*
- Eliminates water intrusion\*\*
- Sold assembled
- Single step installation
- Greatly reduces labor cost
- Fits duct sizes up to 6" diameter
- 100% non corrosive material
- Box cavity designed not to interfere with structural design

### FEATURES

- Interior monolithic cavity, positive pitch sidewalls
- Mounted flush with exterior building surface
- Paintable, primer required
- Gravity back draft dampers
- Removable front louver for periodic maintenance and inspections
- Face louver is attached with four stainless steel screws
- Impact resistant
- UV stabilized
- Available in White or Custom colors

\* with proper interior environmental conditions

\*\* in accordance with manufacturer recommendations, connected to a ducted system