

WYNDHAM COLLECTION

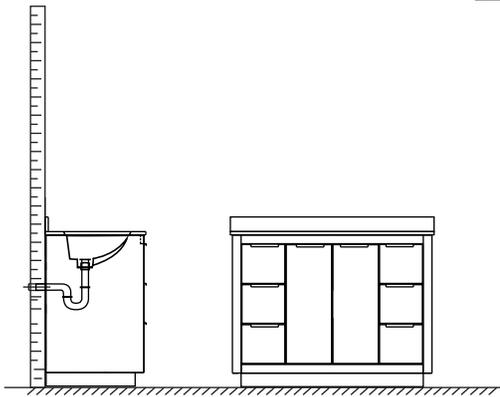

- Prior to installation please check received items against the "Packing List". Please report any missing items to your retailer immediately.
- Protect all surfaces from sharp objects, high heat sources, direct prolonged sunlight and chemical hazards.
- Professional installation recommended.
- Please install on a level surface. If minor door and drawer alignment is required, please follow the easy directions below.

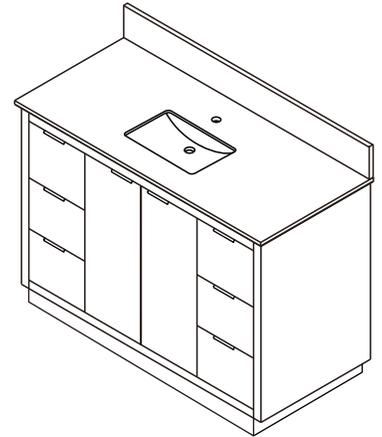

PACKING LIST

(Not all components may be included, depending upon your purchase)

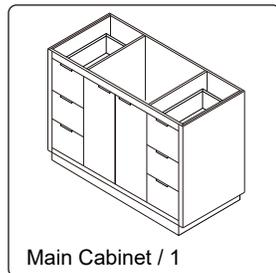
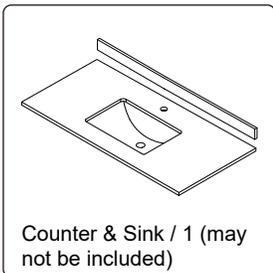

HOW TO ADJUST HINGES (if required)

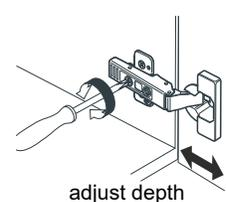
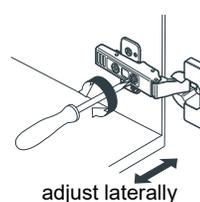
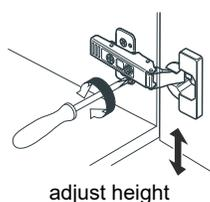
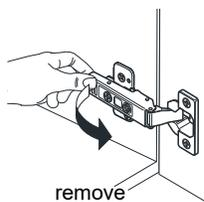
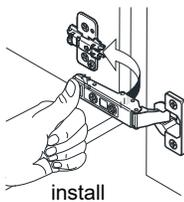

REQUIRED TOOLS NOT IN BOX

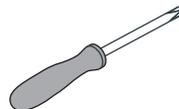

WC-2828-48-SGL Installation Guide

WYNDHAM COLLECTION

INSTALLATION INSTRUCTIONS

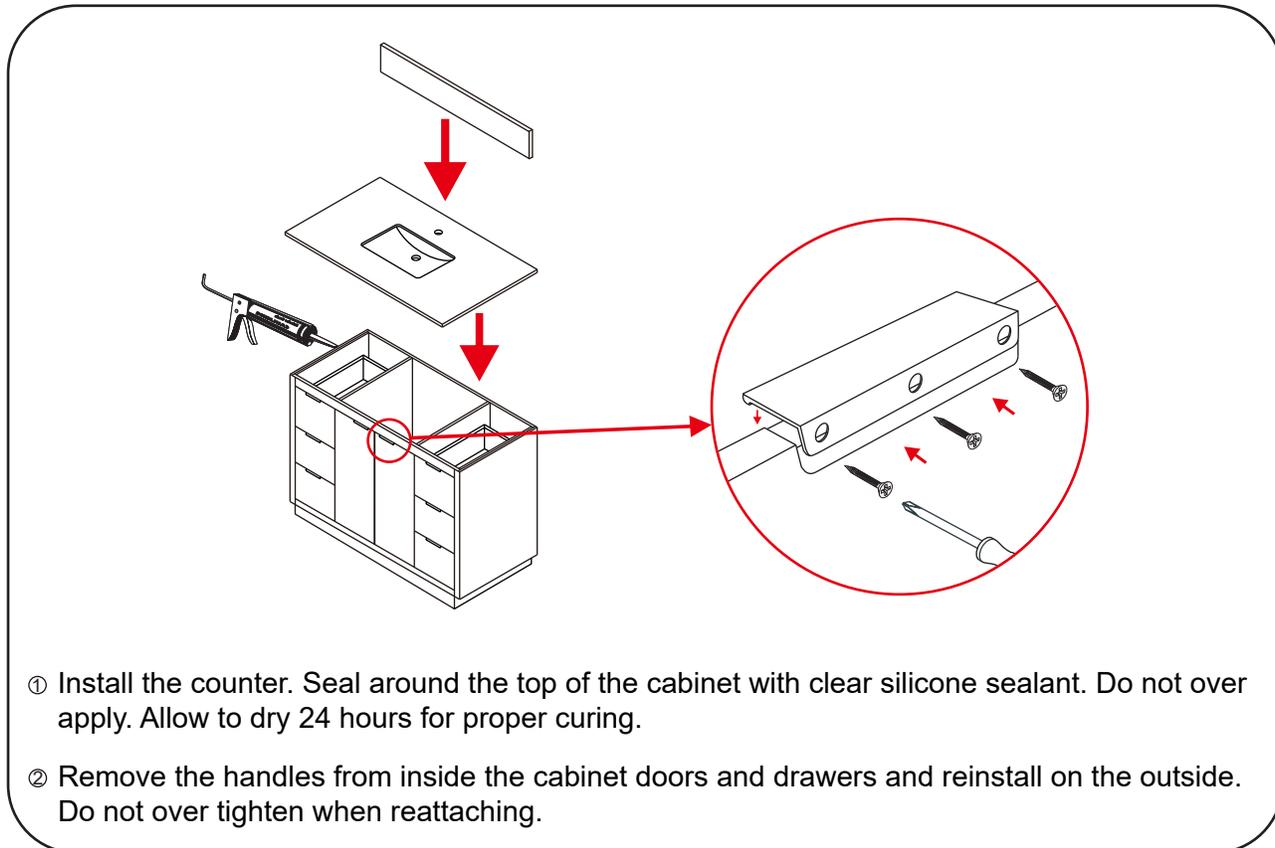

HOW TO ADJUST DRAWER SLIDES (if required)

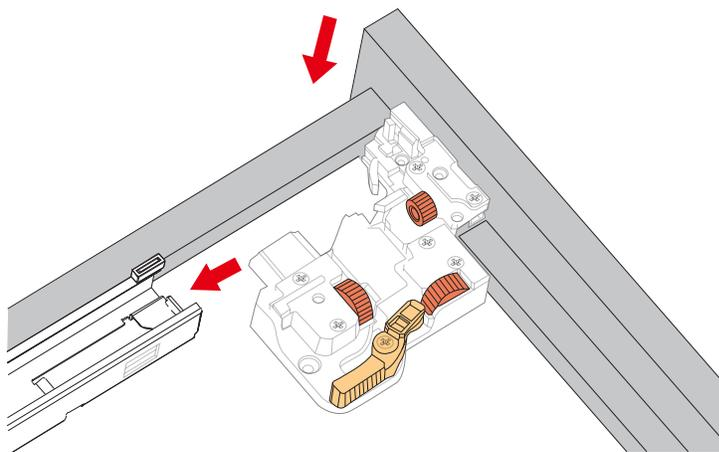

Up and Down Adjustment

WC-2828-48-SGL
Installation Guide

WYNDHAM COLLECTION

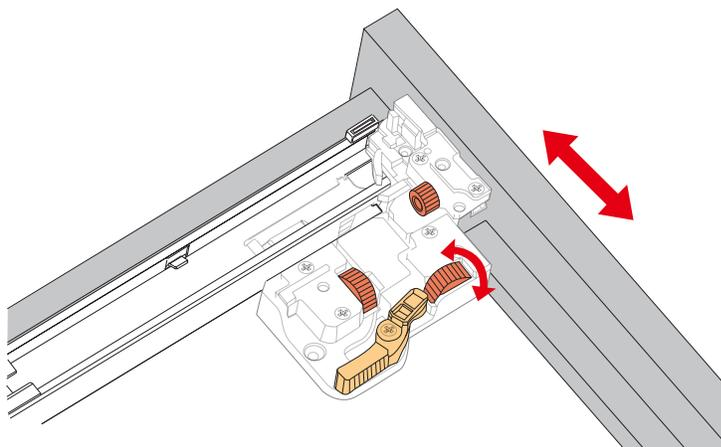

Side Adjustment

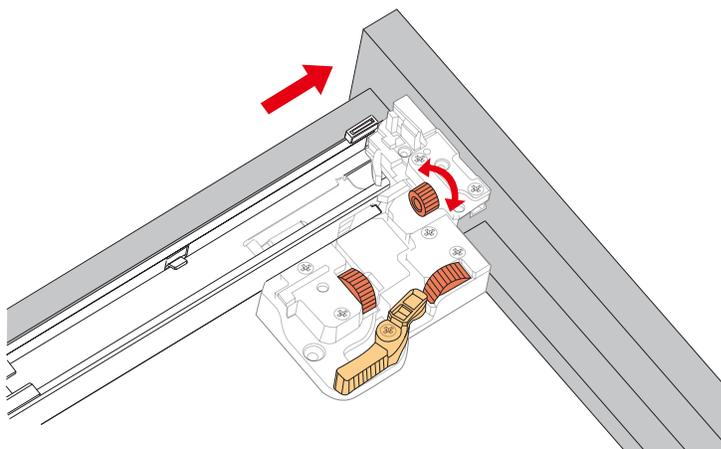

Depth Adjustment

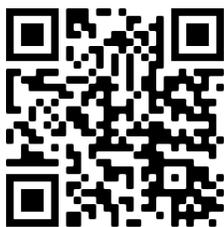

Scan the QR code with your phone to watch detailed video instructions or visit www.wyndhamcollection.com/3dslides

WC-2828-48-SGL
Installation Guide