

WYNDHAM COLLECTION

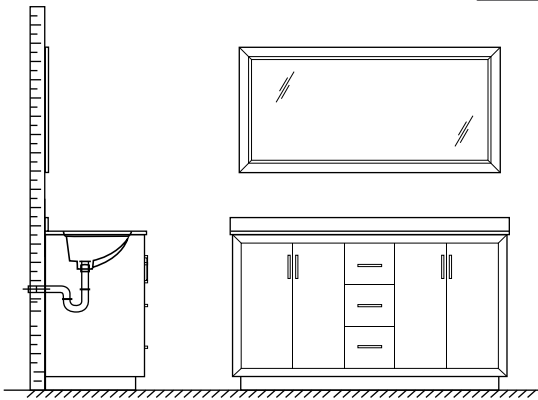

- Prior to installation please check received items against the "Packing List". Please report any missing items to your retailer immediately.
- Protect all surfaces from sharp objects, high heat sources, direct prolonged sunlight and chemical hazards.
- Professional installation recommended.
- Please install on a level surface. If minor door and drawer alignment is required, please follow the easy directions below.
- Backsplash comes in two pieces.

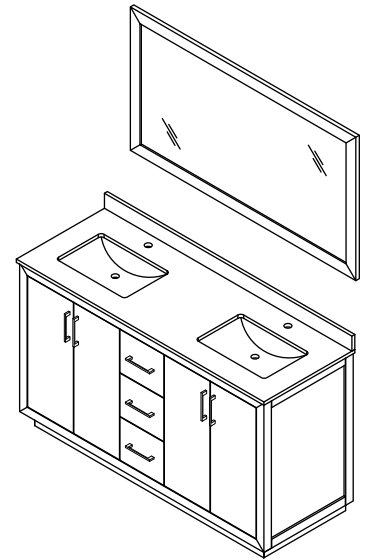

PACKING LIST

(Not all components may be included, depending upon your purchase)

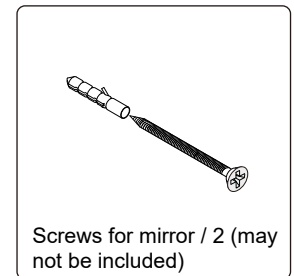
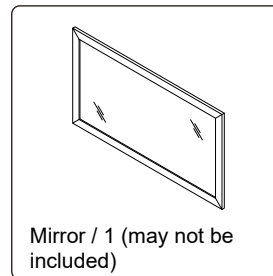
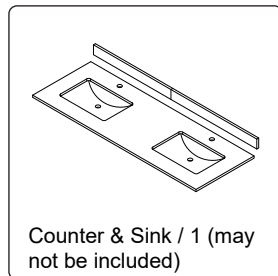
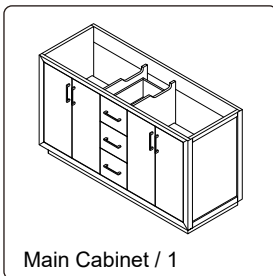

HOW TO ADJUST HINGES (if required)

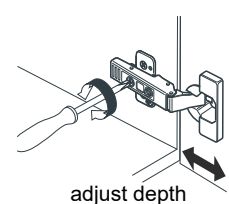
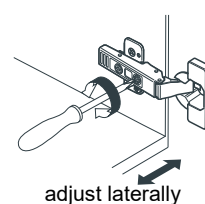
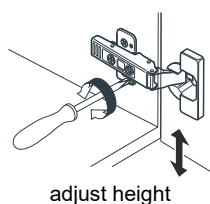
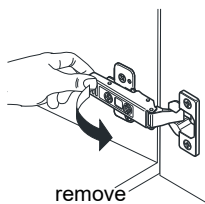
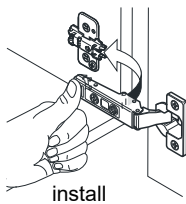

REQUIRED TOOLS NOT IN BOX

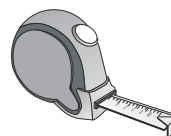
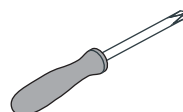
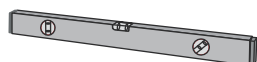

WC-4141-60-DBL Installation Guide

WYNDHAM COLLECTION

INSTALLATION INSTRUCTIONS

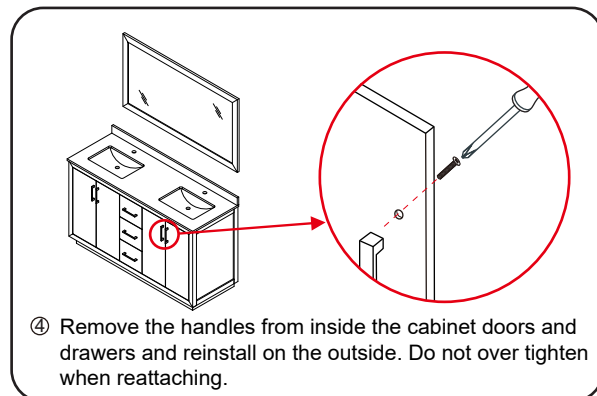
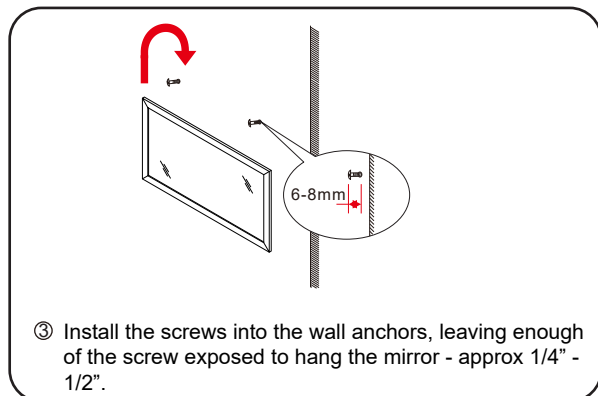
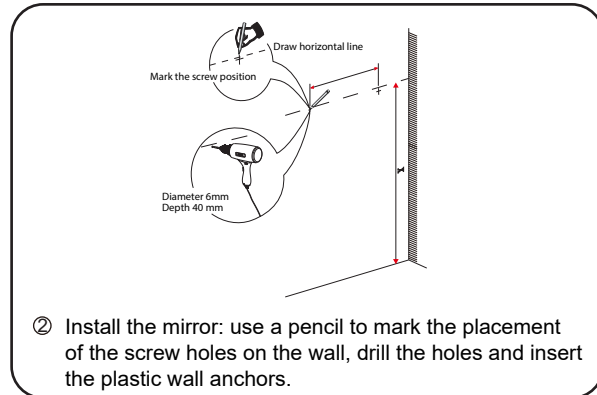
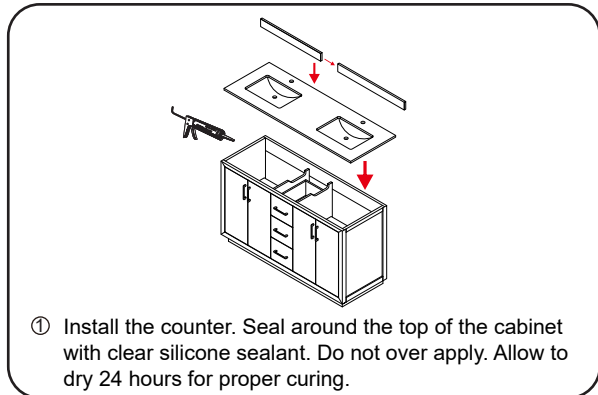

HOW TO ADJUST DRAWER SLIDES (if required)

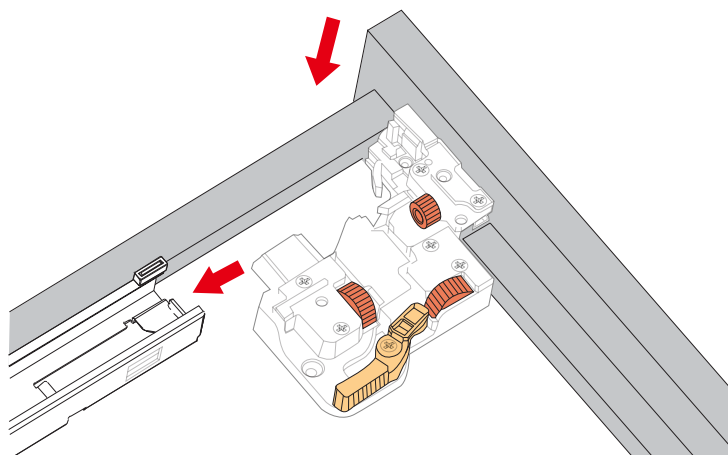

Up and Down Adjustment

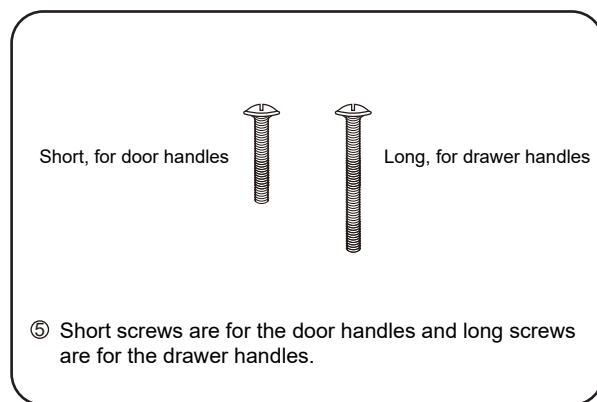

WC-4141-60-DBL Installation Guide

WYNDHAM COLLECTION

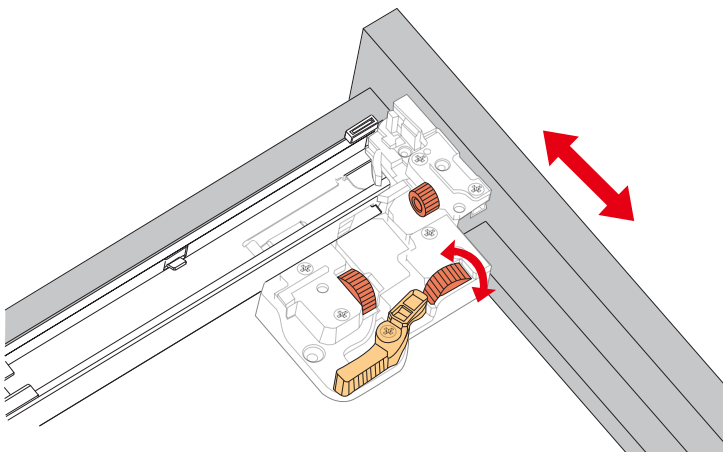

Side Adjustment

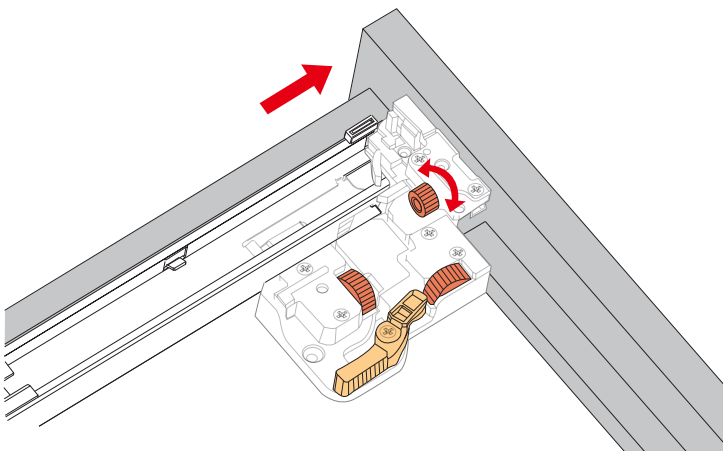

Depth Adjustment



Scan the QR code with your phone to watch detailed video instructions or visit www.wyndhamcollection.com/3dslides

WC-4141-60-DBL
Installation Guide

WYNDHAM COLLECTION

Backboard Cutouts

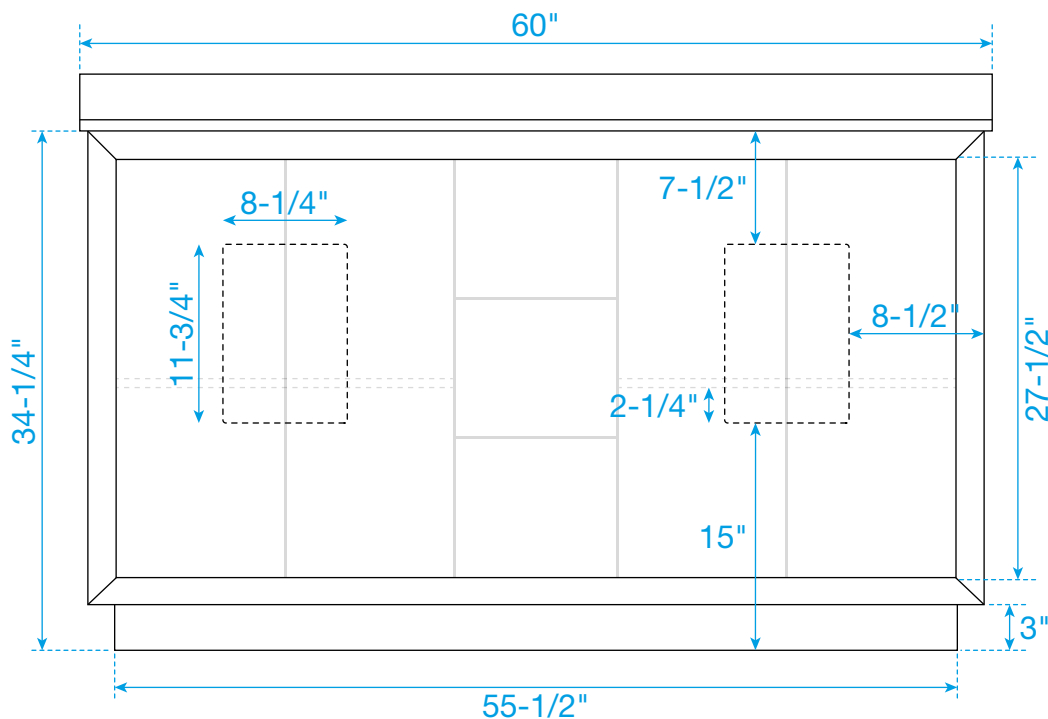

*Note: All measurements are $\pm 1/4$ ".

Electrical Outlets with Charging Hub

- Easy to install
- Long 5 foot plug in cord
- 2 electrical outlets, 125V 15A
- Tamper Resistant (TR) outlets
- Power reset switch
- 2 USB ports, 5V 2.1A Max
- Use with ground-fault circuit interrupter (GFCI) outlets only
- Residential use only
- Follow all applicable electrical codes
- ETL Listed
- Conforms to UL Standard 962A
- Certified to CAN/CSA Standard C22.2 No. 308

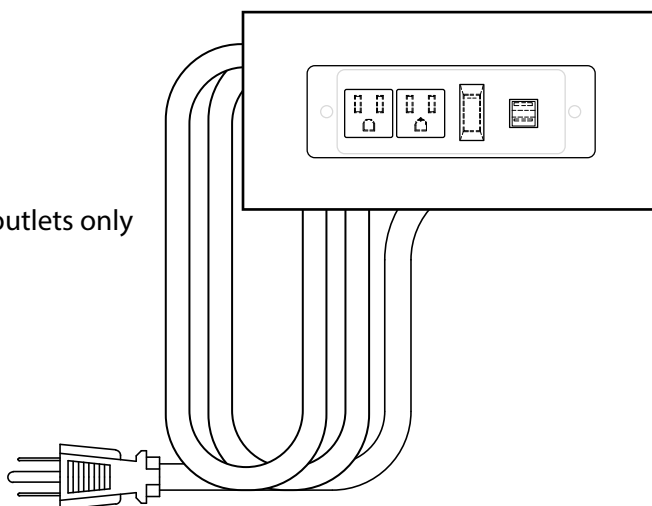

WC-4141-60-DBL Installation Guide