

WYNDHAM COLLECTION

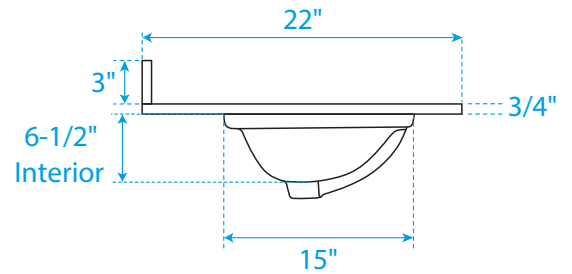
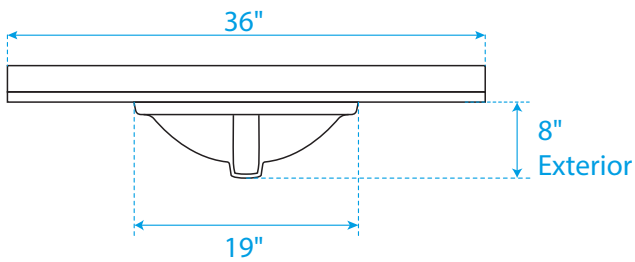
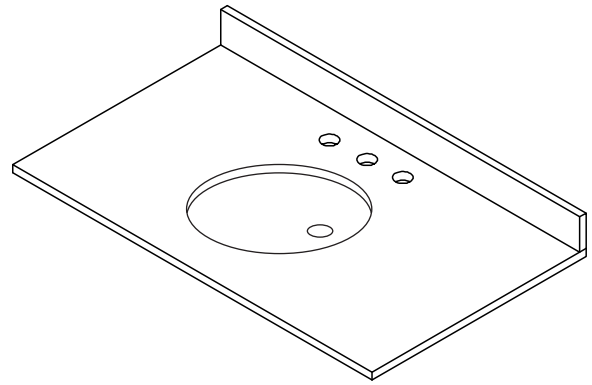
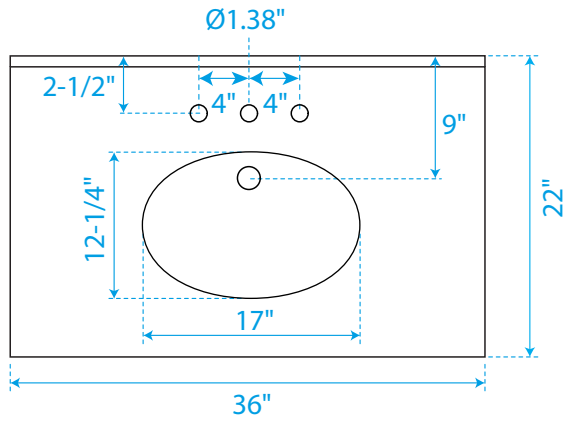

Note: All measurements are $\pm 1/4"$.

WC-1414-36-SGL-TOP
UMOV