

WYNDHAM COLLECTION

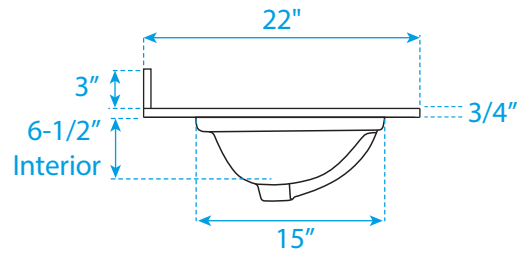
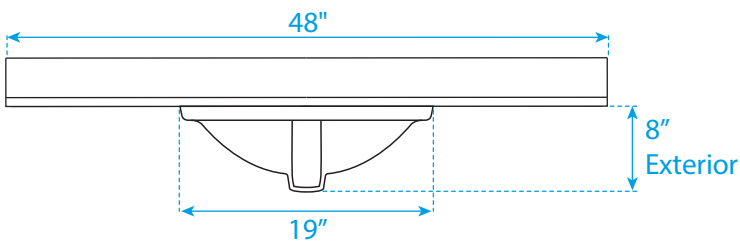
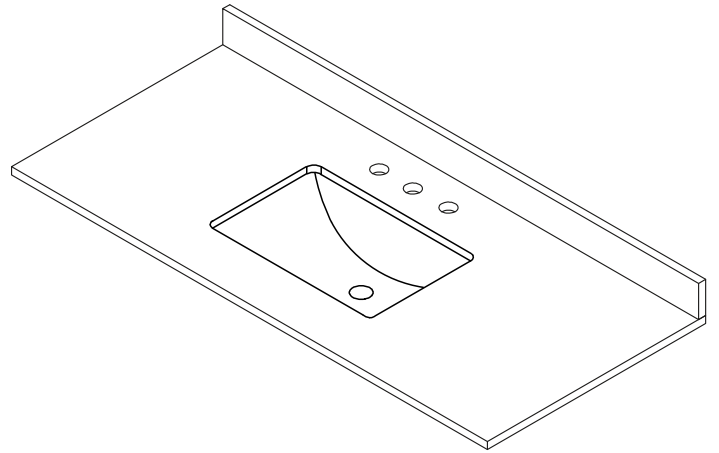
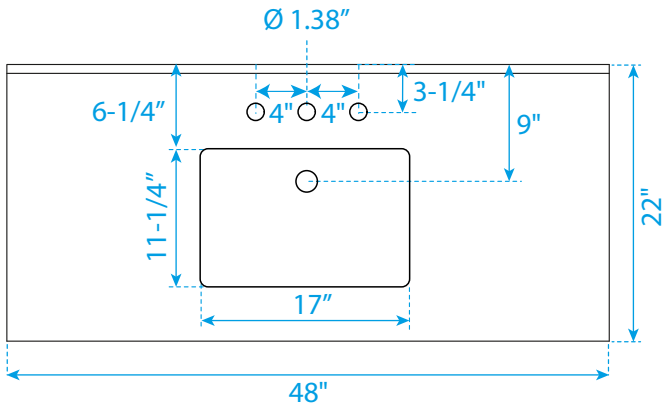

Note: All Measurements are $\pm 1/4"$.

WC-2020-48-SGL-TOP