

WYNDHAM COLLECTION

Edge Profile - Eased

Note - All Measurements are $\pm 1/4"$.

Due to the high probability of breakage, **the backsplash comes in two pieces**, cut from the same piece.

Replacement for Wyndham Collection products (except Andover).

Products from other brands may not be compatible.

Marble is a natural stone so variations in color and grain will occur and are completely normal. We cannot guarantee an exact match to your existing counter.

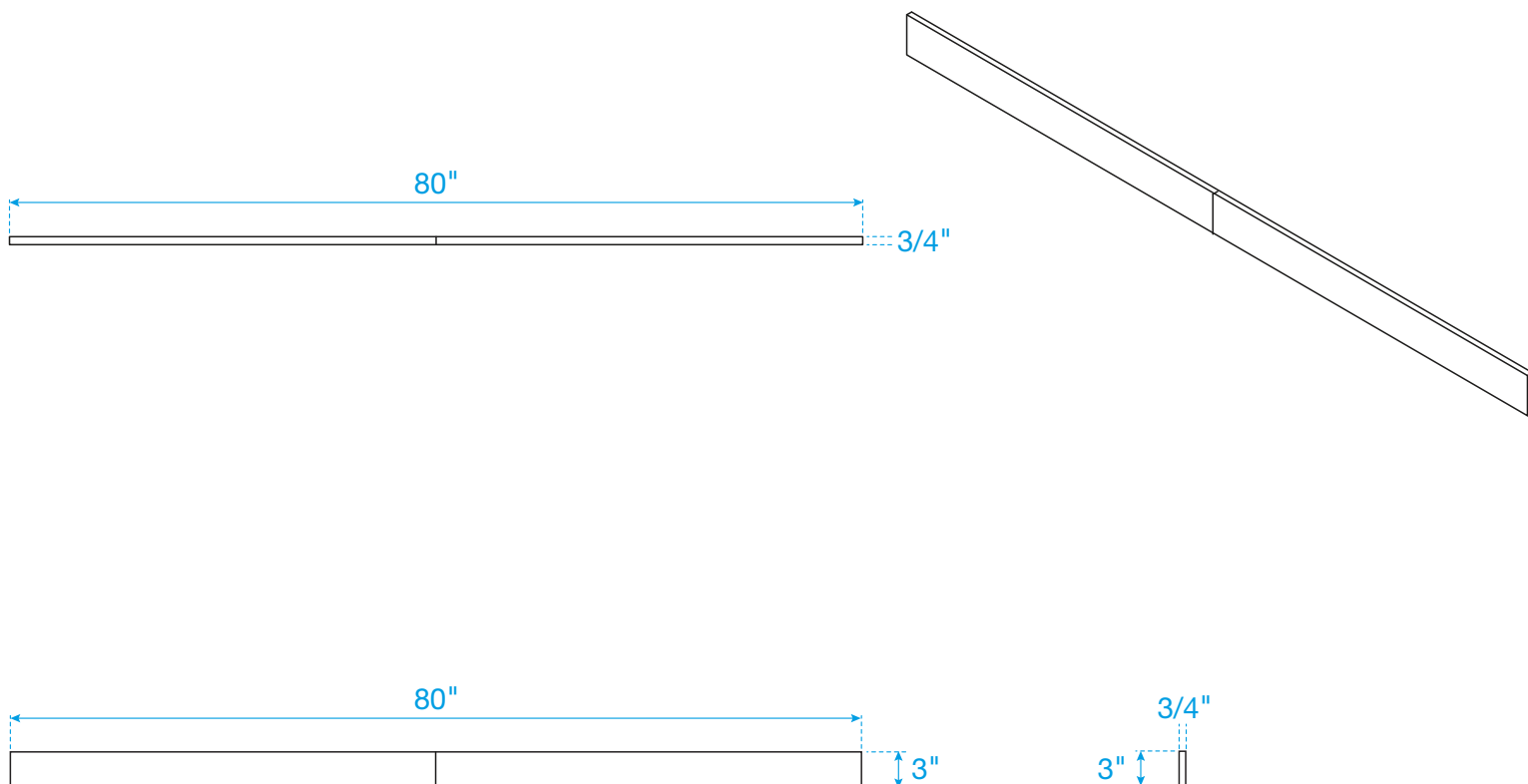

WC-1414-80-BS