

WYNDHAM COLLECTION

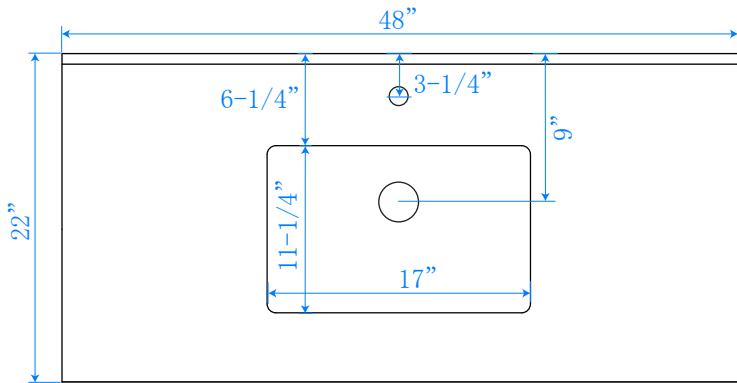

TOP VIEW OF VANITY CABINET

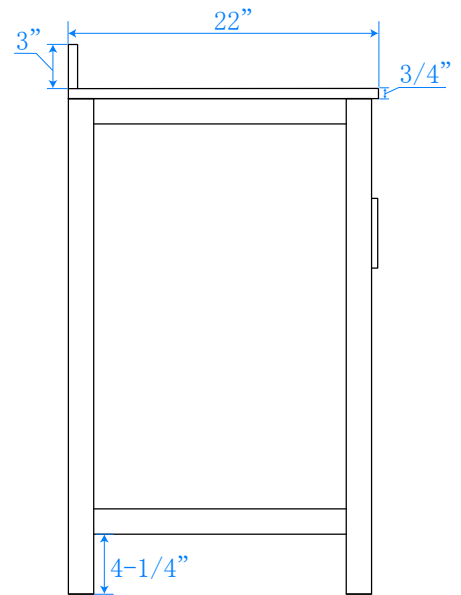
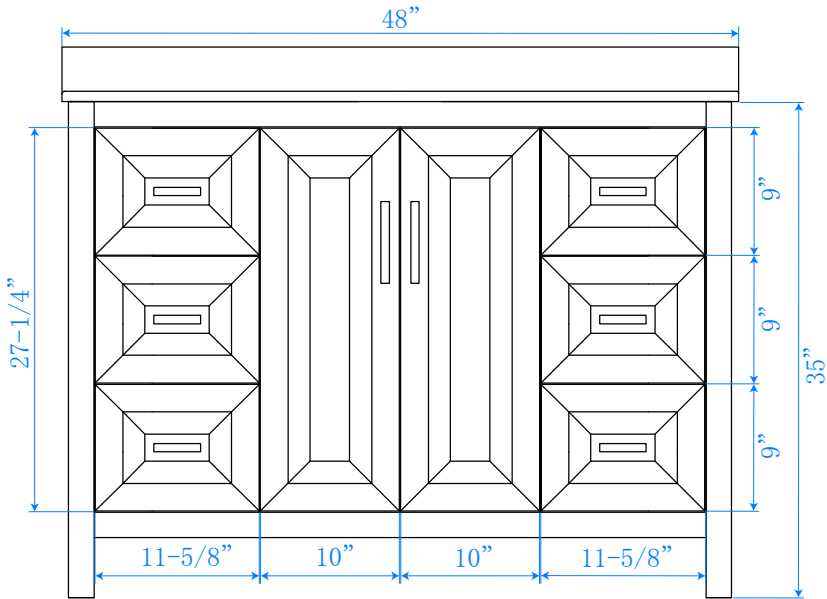
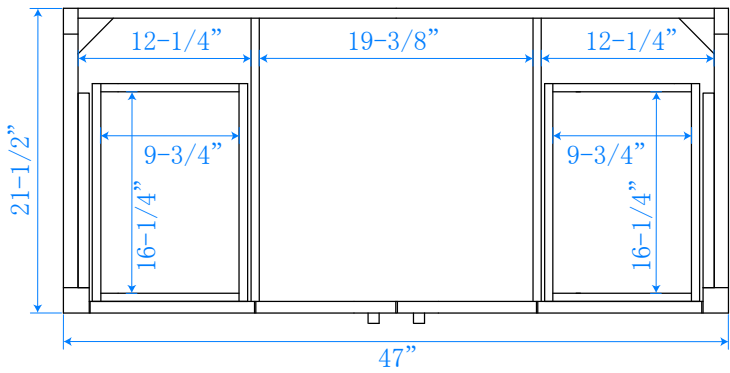
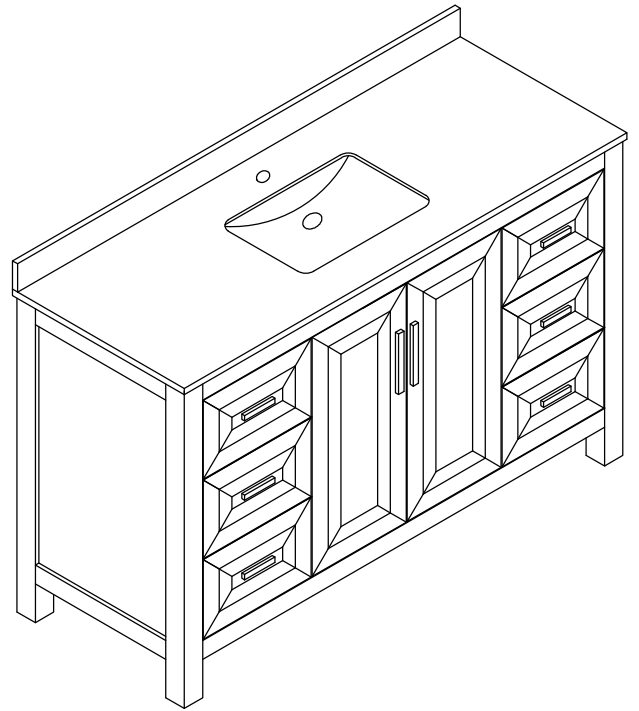

Note: All Measurements are $\pm 1/4"$

WC-2525-48