

WYNDHAM COLLECTION

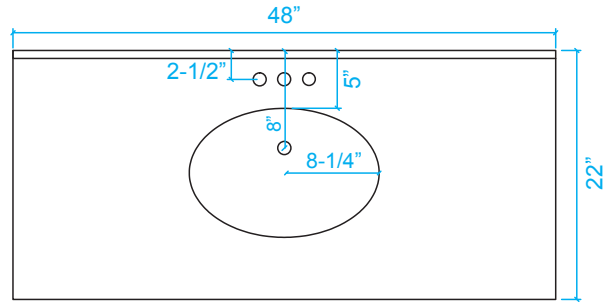

TOP VIEW OF VANITY CABINET

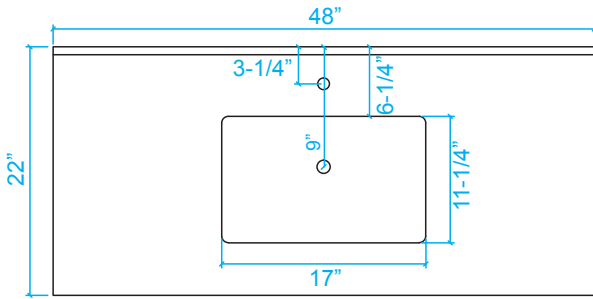
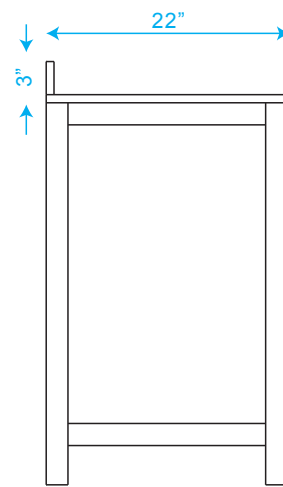
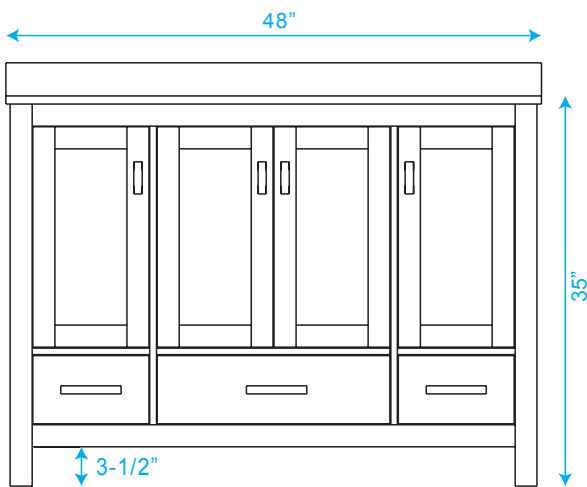
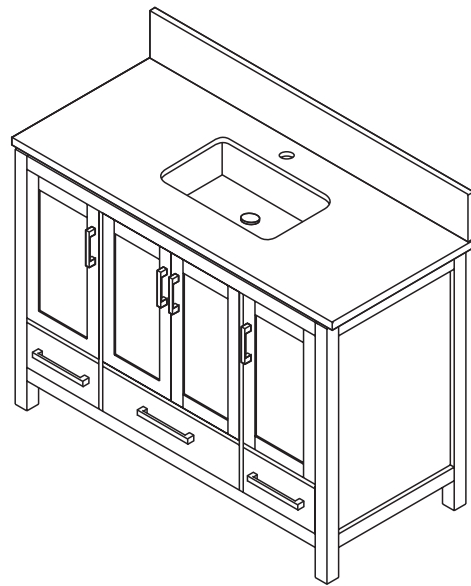
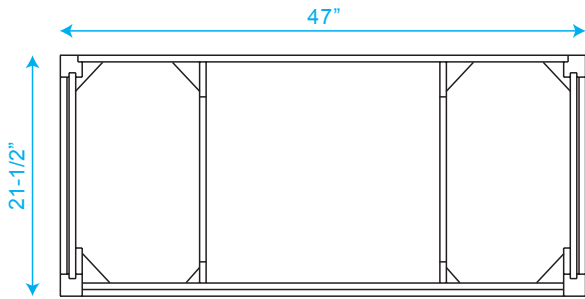

*Note: All Measurements are $\pm 1/4"$

WC-1414-48