

WYNDHAM COLLECTION

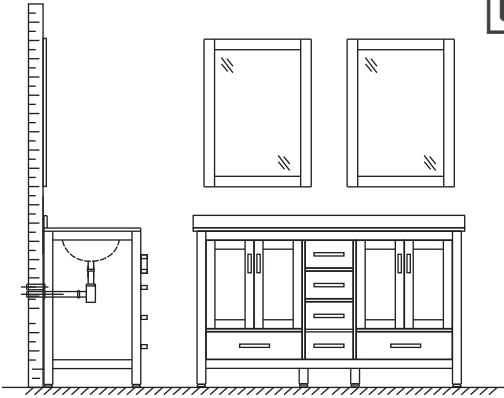

- Prior to installation please check received items against the "Packing List". Please report any missing items to your retailer immediately.
- Protect all surfaces from sharp objects, high heat sources, direct prolonged sunlight and chemical hazards.
- Professional installation recommended.
- Backsplash comes in two pieces.

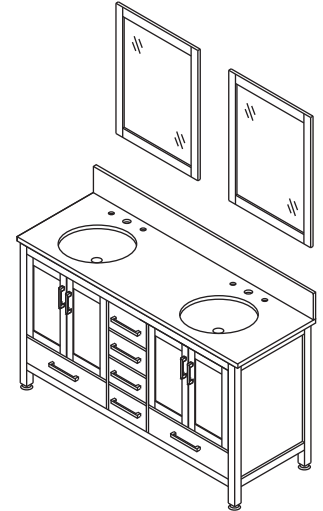

PACKING LIST

(Not all components may be included, depending upon your purchase)

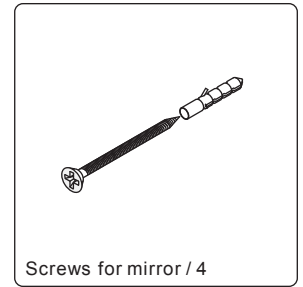
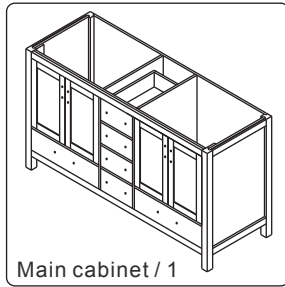
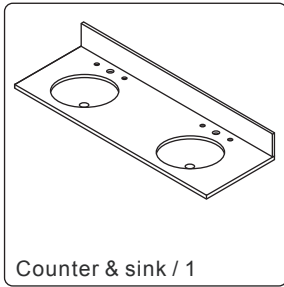

HOW TO ADJUST HINGES (if required)

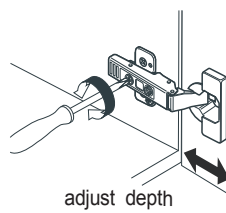
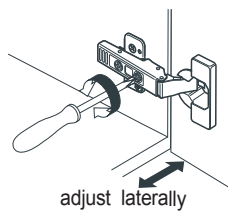
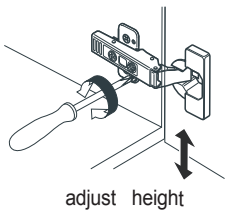

REQUIRED TOOLS NOT IN BOX

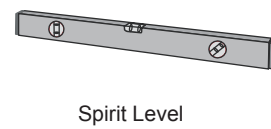
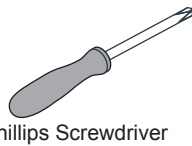
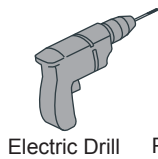
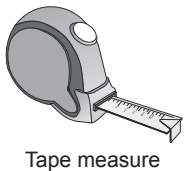

WC-1414-80 Installation Guide

WYNDHAM COLLECTION

INSTALLATION INSTRUCTIONS

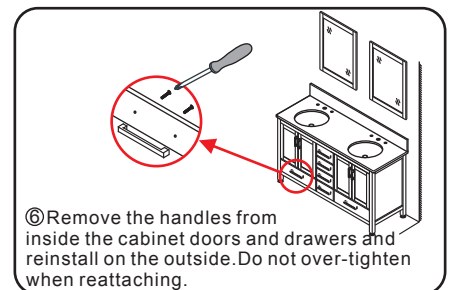
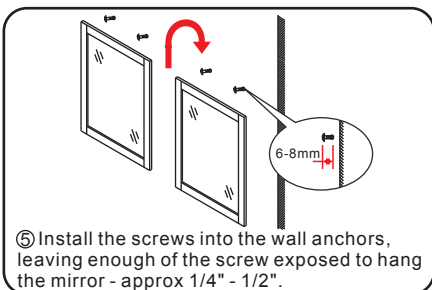
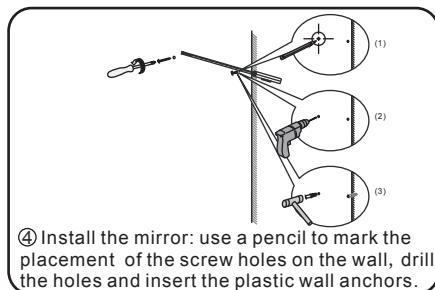
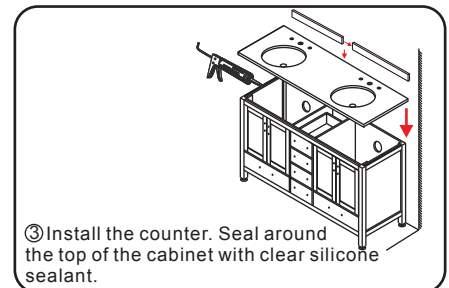
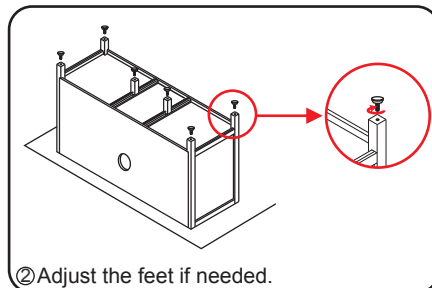
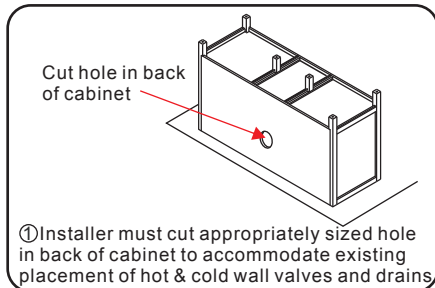

WC-1414-80 Installation Guide