

## Features

- Complete Vanity Unit Available in 4 Finishes
- Free standing installation with 4 legs in bright chrome
- Two soft close drawers; one soft close door with 105 degree opening capability
- Includes integrated sink and vanity top in ceramic white
- Sink with faucet hole and overflow
- Fully Assembled
- Structure and front made of engineered wood textured in high gloss lacquered colors
- Handle integrated in front of furniture
- Hidden hanging bracket directly assembled with great resistance and depth regulations
- Made in Spain





## Elegance 60



### SKU# | Option:

- Elegance 60 WG | Glossy White
- Elegance 60 AN | Anthracite
- Elegance 60 SG | Sandy Grey
- Elegance 60 WE | Wenge

### Finishes

-  Glossy White
-  Anthracite
-  Sandy Grey
-  Wenge

<b>Collection</b> Elegance	<b>Model  </b> Elegance 60	<b>Dimensions Metric</b> <i>1 inch = 2.54 cm</i> <i>1 inch = 25.4 mm</i>	 1051 Lea Drive - Collegeville, PA 19426 Tel. 215 513 9400 - Fax 610 831 0215 <a href="http://www.ws bathcollections.com">www.ws bathcollections.com</a> - <a href="mailto:info@ws bathcollections.com">info@ws bathcollections.com</a>
-------------------------------	-------------------------------	--	---

# Product Specs Sheets

## ELEGANCE

### UNIT

Depth 18

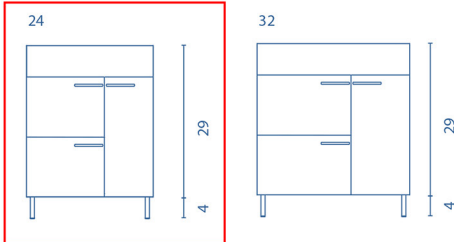

### WASHBASIN

Slim

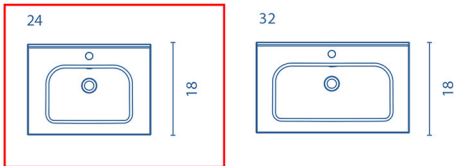

### TECHNICAL INFORMATION

- STRUCTURE:** High gloss lacquered 5/8 in. board and melamine 5/8 in. board
- FRONT :** High gloss lacquered 5/8 in. board and melamine 5/8 in. board
- HANDLE:** Sandy grey - Matt white finish / Essence wenge - Matt black finish / White - Metallic bright chrome finish.
- HINGE:** 105° opening, Ø 1 in. cap, easy assembly and soft closing system.
- PIEDS:** ABS, metallic in the finish of the handle.
- TUBE DEPTH:** Tube depth 2 <sup>3</sup>/<sub>4</sub> in.

### SIPHON PLACEMENT

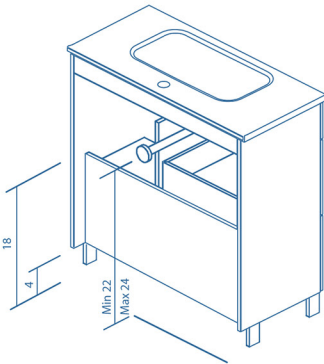

### Finishes



**Collection**  
Elegance

**Model |**  
Elegance 60

### Dimensions Metric

1 inch = 2.54 cm  
1 inch = 25.4 mm

**WS**®  
**BATH**  
**COLLECTIONS**

1051 Lea Drive - Collegeville, PA 19426  
Tel. 215 513 9400 - Fax 610 831 0215  
[www.ws bathcollections.com](http://www.ws bathcollections.com) - [info@ws bathcollections.com](mailto:info@ws bathcollections.com)

We recommend the following items that work with your sink.

Elegance 60

## TRAPS



WSBC 53922  
*Our best seller*

Polished Chrome  
WSBC 53922.29

Matte Black  
WSBC 53922.22



WSBC 5392

Polished Chrome  
WSBC 5392.29



WSBC 53925

Polished Chrome  
WSBC 53925.29



WSBC 53921  
*Space saving*

Polished Chrome  
WSBC 53921.29

Matte Black  
WSBC 53921.22

## DRAINS



WSBC 53991  
Push waste drain (click clack)  
*with overflow*

Polished Chrome  
WSBC 53991.29

Glossy White  
WSBC 53991.09

Glossy Black  
WSBC 53991.18

Matte White  
WSBC 53991.26

Matte Black  
WSBC 53991.22

## MOUNTING HARDWARE

### Wall-mount installation

### Vessel/ countertop installation



Bolts



Silicone (optional)

Collection  
Elegance

Model |  
Elegance 60

Dimensions Metric  
*1 inch = 2.54 cm*  
*1 inch = 25.4 mm*

**WS**®  
**BATH**  
**COLLECTIONS**

1051 Lea Drive - Collegeville, PA 19426  
Tel. 215 513 9400 - Fax 610 831 0215  
[www.ws bathcollections.com](http://www.ws bathcollections.com) - [info@ws bathcollections.com](mailto:info@ws bathcollections.com)