

Palma C100

Features



- Complete Vanity Unit
- Wall-hung design offers a clean, streamlined look
- Two soft close drawers with organizer in upper drawer
- One soft close door
- Includes integrated sink and vanity top in gloss white ceramic; sink has a faucet hole and an overflow
- Fully assembled with structure and front made of engineered wood in wood finishes
- Handle integrated in front of furniture
- Hidden hanging bracket directly assembled with great resistance and depth regulations
- Made in Spain



Related Items:

- WSBC 53991 | Push Waste Drain
- WSBC 53922 | Decorative Trap

Finishes:

-  Matte White
-  Natural Oak
-  Moka Matte

SKU# | Options:

- Palma C100.100 WM | Matte White
- Palma C100.100 NO | Natural Oak
- Palma C100.100 MKM | Moka Matte

Codes & Standards:

- CARB2 Compliant and Certified
- TSCA Compliant and Certified

* WS Bath Collections reserves the right to revise dimensions or information on this sheet without notice

Collection |
Palma

Model |
Palma C100

Dimensions Metric

1 inch = 2.54 cm

1 inch = 25.4 mm

WS[®]
BATH
COLLECTIONS

1051 Lea Drive - Collegeville, PA 19426
Tel. 215 513 9400 - Fax 610 831 0215

www.ws bathcollections.com - info@ws bathcollectins.com

Palma C100

Sink

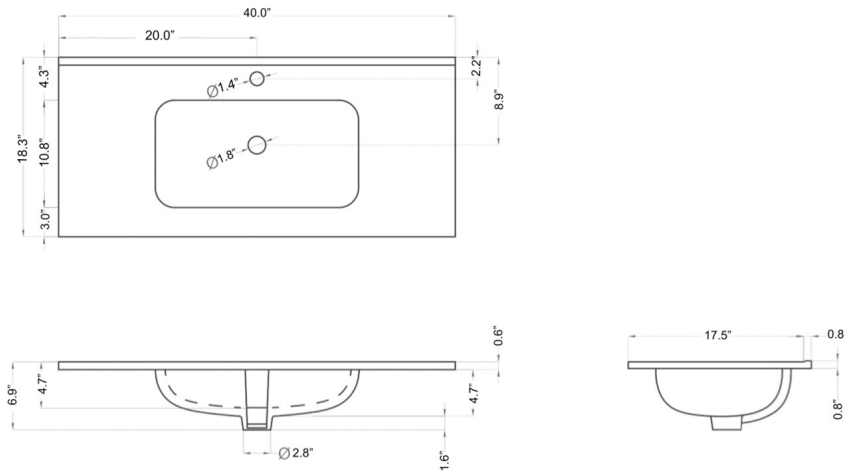

Base Unit

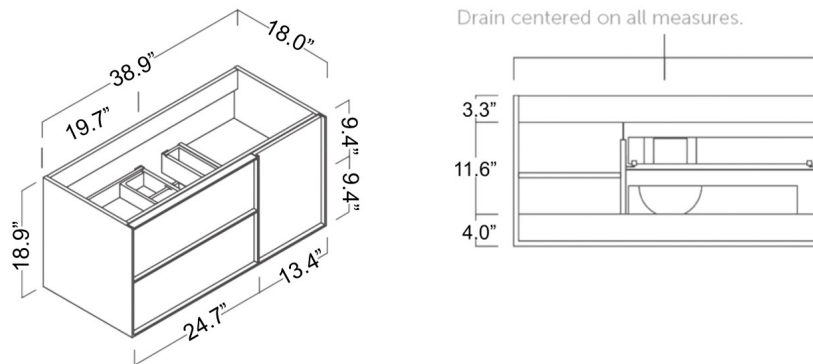

Drain centered on all measures.

Technical information



- Height and depth adjustable suspension.
- 2 adjustable drawers and door with silents-low closing and integrated handles.
- 16 mm MDF front / 16 mm MDF side panels.

Collection |
Palma

Model |
Palma C100

Dimensions Metric
1 inch = 2.54 cm
1 inch = 25.4 mm

WS®
BATH
COLLECTIONS

1051 Lea Drive - Collegeville, PA 19426
Tel. 215 513 9400 - Fax 610 831 0215

www.ws bathcollections.com - info@ws bathcollectins.com

We recommend the following items that work with your sink.

Palma C100

TRAPS



WSBC 53922
Our best seller

-  Polished Chrome
WSBC 53922.29
-  Matte Black
WSBC 53922.22



WSBC 5392

-  Polished Chrome
WSBC 5392.29



WSBC 53925

-  Polished Chrome
WSBC 53925.29



WSBC 53921
Space saving

-  Polished Chrome
WSBC 53921.29
-  Matte Black
WSBC 53921.22

DRAINS



WSBC 53991
Push waste drain (click clack)
with overflow

-  Polished Chrome
WSBC 53991.29
-  Glossy White
WSBC 53991.09
-  Glossy Black
WSBC 53991.18
-  Matte White
WSBC 53991.26
-  Matte Black
WSBC 53991.22

MOUNTING HARDWARE

Wall-Mount Installation

Vessel/Countertop Installation



Bolts



Silicone (optional)

Collection |
Palma

Model |
Palma C100

Dimensions Metric

1 inch = 2.54 cm
1 inch = 25.4 mm



1051 Lea Drive - Collegeville, PA 19426
Tel. 215 513 9400 - Fax 610 831 0215
www.ws bathcollections.com - info@ws bathcollectins.com