

## Features

- Vanity Base Unit
- Available in 4 Finishes: Glossy White, Anthracite, Sandy Grey, and Wenge
- Free standing installation with 4 legs in bright chrome
- Two soft close drawers; one soft close door with 105 degree opening capability for easy cabinet access
- Fully Assembled
- Structure and front made of engineered wood in wood finishes and high gloss lacquered
- Handle integrated in front of furniture
- Hidden hanging bracket directly assembled with great resistance and depth regulation
- Made in Spain





## Elegance 80 Base



## SKU# | Option:

- Elegance 80 AN Base | Anthracite
- Elegance 80 SG Base | Sandy Grey
- Elegance 80 WE Base | Wenge
- Elegance 80 WG Base | Glossy White

## Finishes

-  Anthracite
-  Sandy Grey
-  Wenge
-  Glossy White

**Collection**  
Elegance Vanities

**Model |**  
Elegance 80 Base

Dimensions Metric

*1 inch = 2.54 cm*  
*1 inch = 25.4 mm*

**WS**®  
**BATH**  
**COLLECTIONS**

1051 Lea Drive - Collegeville, PA 19426  
Tel. 215 513 9400 - Fax 610 831 0215

[www.ws bathcollections.com](http://www.ws bathcollections.com) - [info@ws bathcollectins.com](mailto:info@ws bathcollectins.com)

# Product Specs Sheets

## ELEGANCE

### UNIT

Depth 18

24

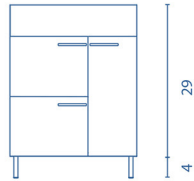

32

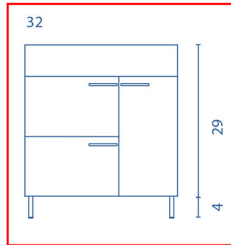

### TECHNICAL INFORMATION

- STRUCTURE:** High gloss lacquered 5/8 in. board and melamine 5/8 in. board
- FRONT :** High gloss lacquered 5/8 in. board and melamine 5/8 in. board
- HANDLE:** Sandy grey - Matt white finish / Essence wenge - Matt black finish / White - Metallic bright chrome finish.
- HINGE:** 105° opening, Ø 1 in. cap, easy assembly and soft closing system.
- PIEDS:** ABS, metallic in the finish of the handle.
- TUBE DEPTH:** Tube depth 2<sup>3/4</sup> in.

### SIPHON PLACEMENT

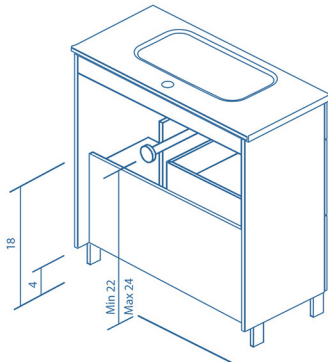

### Finishes



SANDY GREY

ESSENCE WENGE

WHITE

ANTHRACITE

**Collection**  
Elegance Vanities

**Model |**  
Elegance 80 Base

Dimensions Metric

1 inch = 2.54 cm

1 inch = 25.4 mm

**WS**®  
**BATH**  
**COLLECTIONS**

1051 Lea Drive - Collegeville, PA 19426  
Tel. 215 513 9400 - Fax 610 831 0215

[www.ws bathcollections.com](http://www.ws bathcollections.com) - [info@ws bathcollectins.com](mailto:info@ws bathcollectins.com)