

## Ambra 120 DBL Pack 1

### Features

- Complete Vanity Unit With Mirror
- Available in 6 Finishes: Glossy White, Nordic Oak, Anthracite, Samara Ash, Matte White, and Matte Sand
- Wall-hung design offers a clean, streamlined look
- Two soft close drawers with organizer in upper drawer
- Two soft close doors with 105 degree opening capability for easy cabinet access
- Includes integrated sink and vanity top in gloss white ceramic with faucet hole and overflow
- Fully assembled with structure and front made of engineered wood in wood finishes and high gloss lacquered
- Handle integrated in front of furniture
- Hidden hanging bracket directly assembled with great resistance and depth regulations
- Made in Spain



### Related Items:

- WSBC 53991 | Push Waste Drain
- WSBC 53922 | Decorative Trap

### SKU# | Options:

- Ambra 120 DBL Pack 1 NO | Nordic Oak
- Ambra 120 DBL Pack 1 SA | Samara Ash
- Ambra 120 DBL Pack 1 WG | Glossy White
- Ambra 120 DBL Pack 1 AN | Anthracite
- Ambra 120 DBL Pack 1 WM | Matte White
- Ambra 120 DBL Pack 1 SM | Matte Sand

### Finishes:

-  Nordic Oak
-  Samara Ash
-  Glossy White
-  Anthracite
-  Matte White
-  Matte Sand









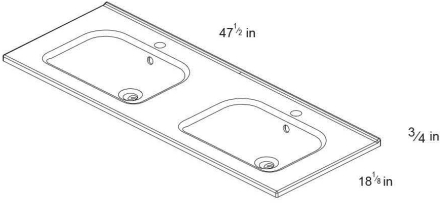

### Codes & Standards:

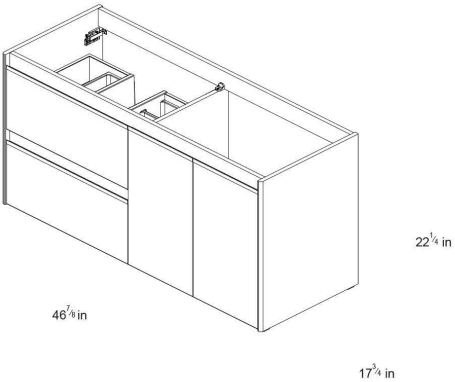
- CARB2 Compliant and Certified
- TSCA Compliant and Certified

\* WS Bath Collections reserves the right to revise dimensions or information on this sheet without notice

|                              |  |   |   |
|------------------------------|--|---|---|
| <b>Collection  </b><br>Ambra | <b>Model  </b><br>Ambra 120 DBL Pack 1 | Dimensions Metric<br><i>1 inch = 2.54 cm</i><br><i>1 inch = 25.4 mm</i> | <br>1051 Lea Drive - Collegeville, PA 19426<br>Tel. 215 513 9400 - Fax 610 831 0215<br><a href="http://www.ws bathcollections.com">www.ws bathcollections.com</a> - <a href="mailto:info@ws bathcollections.com">info@ws bathcollections.com</a> |
|------------------------------|--|---|---|

## Technical features

| Technical drawing  | Name  | Material  | Colour  | Colour  |
|--|---|---|---|---|
|   | <b>SLIM</b>                                 |   |    | Gloss White   |
|  | <b>AMBRA</b><br>1 Door / 2 Drawers / 1 Door | <br><br><br> | <br><br><br> | Nordic Oak<br>Samara Ash<br>Gloss White<br>Anthracite |

## Technical information

|                      |  |
|----------------------|--|
| STRUCTURE            | MDF board in 58 in. continuous wrapping in 2D/ Cyclum Process.   |
| FRONT                | MDF board in 58 in. continuous wrapping in 2D/ Cyclum Process.   |
| HANDLE               | Integrated in the front of the furniture.  |
| DRAWER               | Drawers made in mokka textile poly laminate coated board with hidden partial extraction runners with soft close system. Includes organizer in upper drawer. Lower drawer useful space (widthxhighxdepth): 20 <sup>1/16</sup> x 4 <sup>5/16</sup> x 12 <sup>2/4</sup> in. |
| WALL HANGING BRACKET | Hidden hanging bracket of directly assembled with great resistance and depth regulations.  |
| HINGE                | 105° opening, 1 <sup>3/8</sup> in. cap, easy assembly and soft close system.   |
| LEGS                 | Metallic in bright chrome finish. (optional)   |
| PIPE DEPTH           | Pipe depth 2 <sup>1/54</sup> in.   |

Collection  
Ambra

Model |  
Ambra 120 DBL

Dimensions Metric  
1 inch = 2.54 cm  
1 inch = 25.4 mm

**WS**<sup>®</sup>  
BATH  
COLLECTIONS

1051 Lea Drive - Collegeville, PA 19426  
Tel. 215 513 9400 - Fax 610 831 0215  
[www.ws bathcollections.com](http://www.ws bathcollections.com) - [info@ws bathcollections.com](mailto:info@ws bathcollections.com)

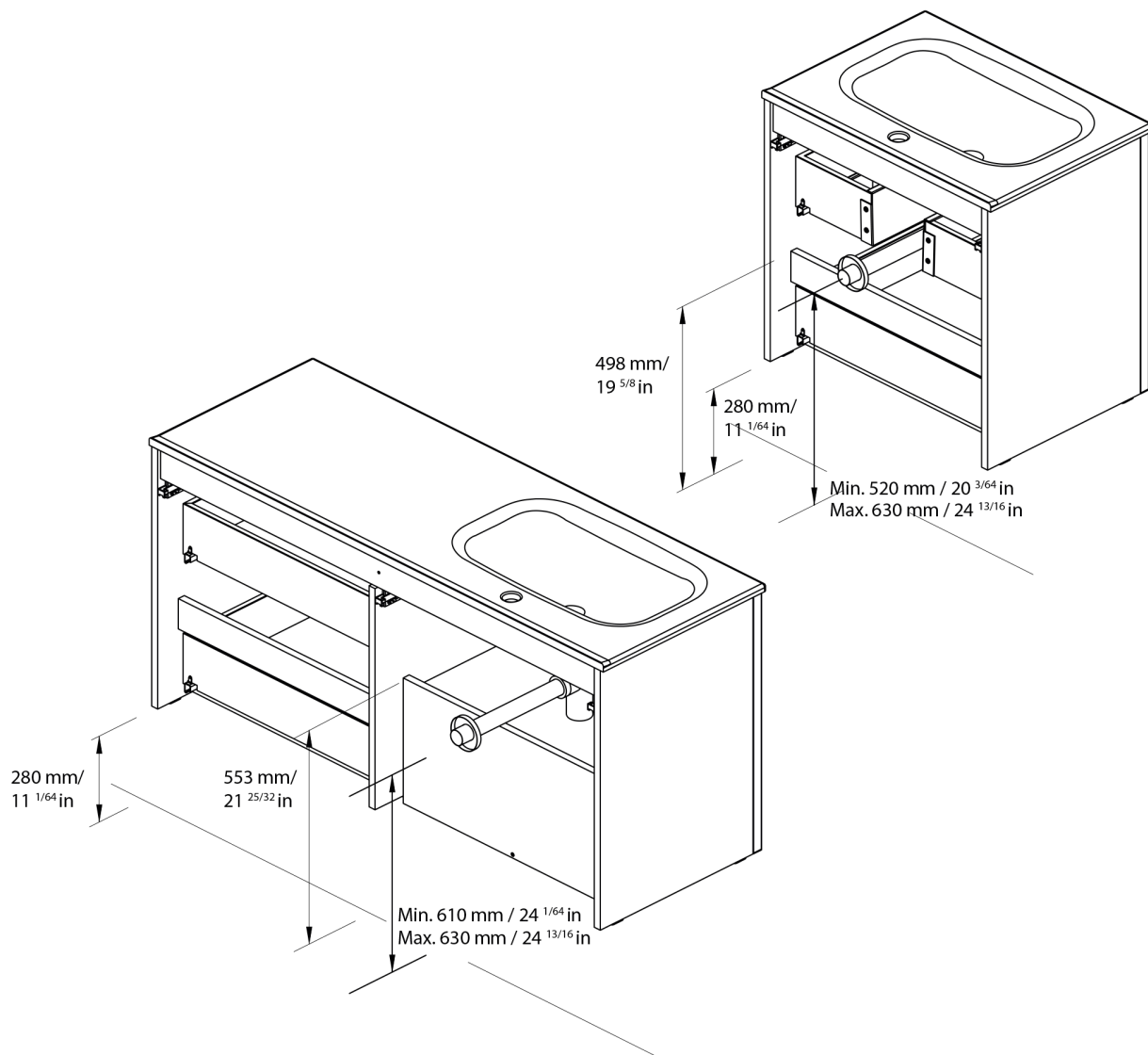

ES

EN

Las cotas indicadas en los dibujos son en función de la altura de la pata del conjunto, en caso de que el mueble vaya suspendido y esta altura no se respete, dichas cotas también variarán.

Dimensions indicated in the drawing are based on the level of the whole leg, in case of wall hanging the furniture dimensions also may vary.

Collection  
Ambra

Model |  
Ambra 120 DBL

Dimensions Metric

1 inch = 2.54 cm  
1 inch = 25.4 mm

WS<sup>®</sup>

BATH  
COLLECTIONS

1051 Lea Drive - Collegeville, PA 19426

Tel. 215 513 9400 - Fax 610 831 0215

[www.ws bathcollections.com](http://www.ws bathcollections.com) - [info@ws bathcollections.com](mailto:info@ws bathcollections.com)

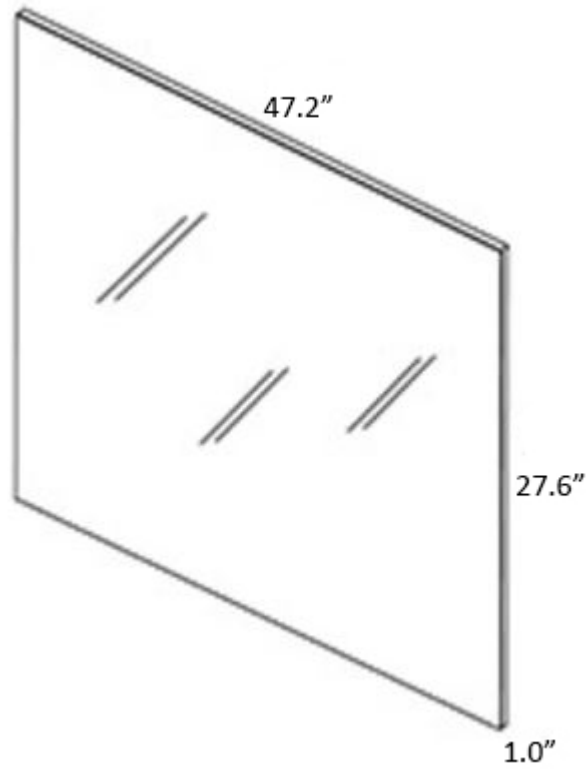

Collection  
Murano

Model |  
Murano 120

Dimensions Metric  
*1 inch = 2.54 cm*  
*1 inch = 25.4 mm*

**WS**<sup>®</sup>  
**BATH**  
**COLLECTIONS**

1051 Lea Drive - Collegeville, PA 19426  
Tel. 215 513 9400 - Fax 610 831 0215  
[www.ws bathcollections.com](http://www.ws bathcollections.com) - [info@ws bathcollections.com](mailto:info@ws bathcollections.com)

We recommend the following items that work with your sink.

Ambra 120 DBL Pack 1

## TRAPS



WSBC 53922  
*Our best seller*

Polished Chrome  
WSBC 53922.29

Matte Black  
WSBC 53922.22



WSBC 5392

Polished Chrome  
WSBC 5392.29



WSBC 53925

Polished Chrome  
WSBC 53925.29



WSBC 53921  
*Space saving*

Polished Chrome  
WSBC 53921.29

Matte Black  
WSBC 53921.22

## DRAINS



WSBC 53991  
Push waste drain (click clack)  
*with overflow*

Polished Chrome  
WSBC 53991.29

Matte Black  
WSBC 53991.22

## MOUNTING HARDWARE

### Wall-mount installation

### Vessel/ countertop installation



Bolts



Silicone (optional)

Collection  
Ambra

Model |  
Ambra 120 DBL Pack 1

Dimensions Metric  
*1 inch = 2.54 cm*  
*1 inch = 25.4 mm*

WS<sup>®</sup>  
BATH  
COLLECTIONS

1051 Lea Drive - Collegeville, PA 19426  
Tel. 215 513 9400 - Fax 610 831 0215  
[www.ws bathcollections.com](http://www.ws bathcollections.com) - [info@ws bathcollections.com](mailto:info@ws bathcollections.com)