

Ambra 80 Pack 1

Features

- Complete Vanity Unit With Mirror
- Available in 6 Finishes: Glossy White, Nordic Oak, Anthracite, Samara Ash, Matte White, and Matte Sand
- Wall-hung design offers a clean, streamlined look
- Two soft close drawers with organizer in upper drawer
- Includes integrated sink and vanity top in gloss white ceramic with faucet hole and overflow
- Fully assembled with structure and front made of engineered wood in wood finishes and high gloss lacquered
- Handle integrated in front of furniture
- Hidden hanging bracket directly assembled with great resistance and depth regulations
- Made in Spain



Related Items:

- WSBC 53991 | Push Waste Drain
- WSBC 53922 | Decorative Trap

SKU# | Options:

- Ambra 80 Pack 1 NO | Nordic Oak
- Ambra 80 Pack 1 SA | Samara Ash
- Ambra 80 Pack 1 WG | Glossy White
- Ambra 80 Pack 1 AN | Anthracite
- Ambra 80 Pack 1 WM | Matte White
- Ambra 80 Pack 1 SM | Matte Sand

Finishes:

-  Nordic Oak
-  Samara Ash
-  Glossy White
-  Anthracite
-  Matte White
-  Matte Sand









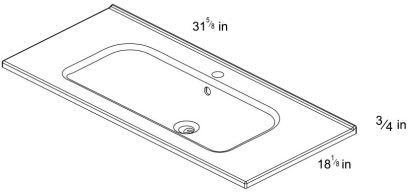

Codes & Standards:

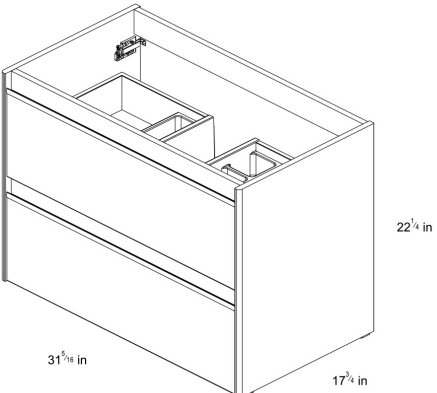
- CARB2 Compliant and Certified
- TSCA Compliant and Certified

* WS Bath Collections reserves the right to revise dimensions or information on this sheet without notice

Collection Ambra	Model Ambra 80 Pack 1	Dimensions Metric <i>1 inch = 2.54 cm</i> <i>1 inch = 25.4 mm</i>	 1051 Lea Drive - Collegeville, PA 19426 Tel. 215 513 9400 - Fax 610 831 0215 www.ws bathcollections.com - info@ws bathcollections.com
------------------------------	-----------------------------------	--	---

Technical features

Technical drawing	Name	Material	Colour	Colour
	SLIM			Gloss White
	AMBRA 2 Drawers	   	   	Nordic Oak Samara Ash Gloss White Anthracite

Technical information

STRUCTURE	MDF board in 5/8 in. continuous wrapping in 2D/ Cyclum Process.
FRONT	MDF board in 5/8 in. continuous wrapping in 2D/ Cyclum Process.
HANDLE	Integrated in the front of the furniture.
DRAWER	Drawers made in mokka textile poly laminate coated board with hidden partial extraction runners with soft close system. Includes organizer in upper drawer. Lower drawer useful space (widthxhighxdepth): 27 ^{15/16} x 4 ^{57/16} x 12 ^{27/4} in.
WALL HANGING BRACKET	Hidden hanging bracket of directly assembled with great resistance and depth regulations.
LEGS	Metallic in bright chrome finish. (optional)
PIPE DEPTH	Pipe depth 2 ^{1/54} in.

Collection
Ambra

Model |
Ambra 80

Dimensions Metric

1 inch = 2.54 cm
1 inch = 25.4 mm

WS[®]
BATH
COLLECTIONS

1051 Lea Drive - Collegeville, PA 19426
Tel. 215 513 9400 - Fax 610 831 0215

www.ws bathcollections.com - info@ws bathcollections.com

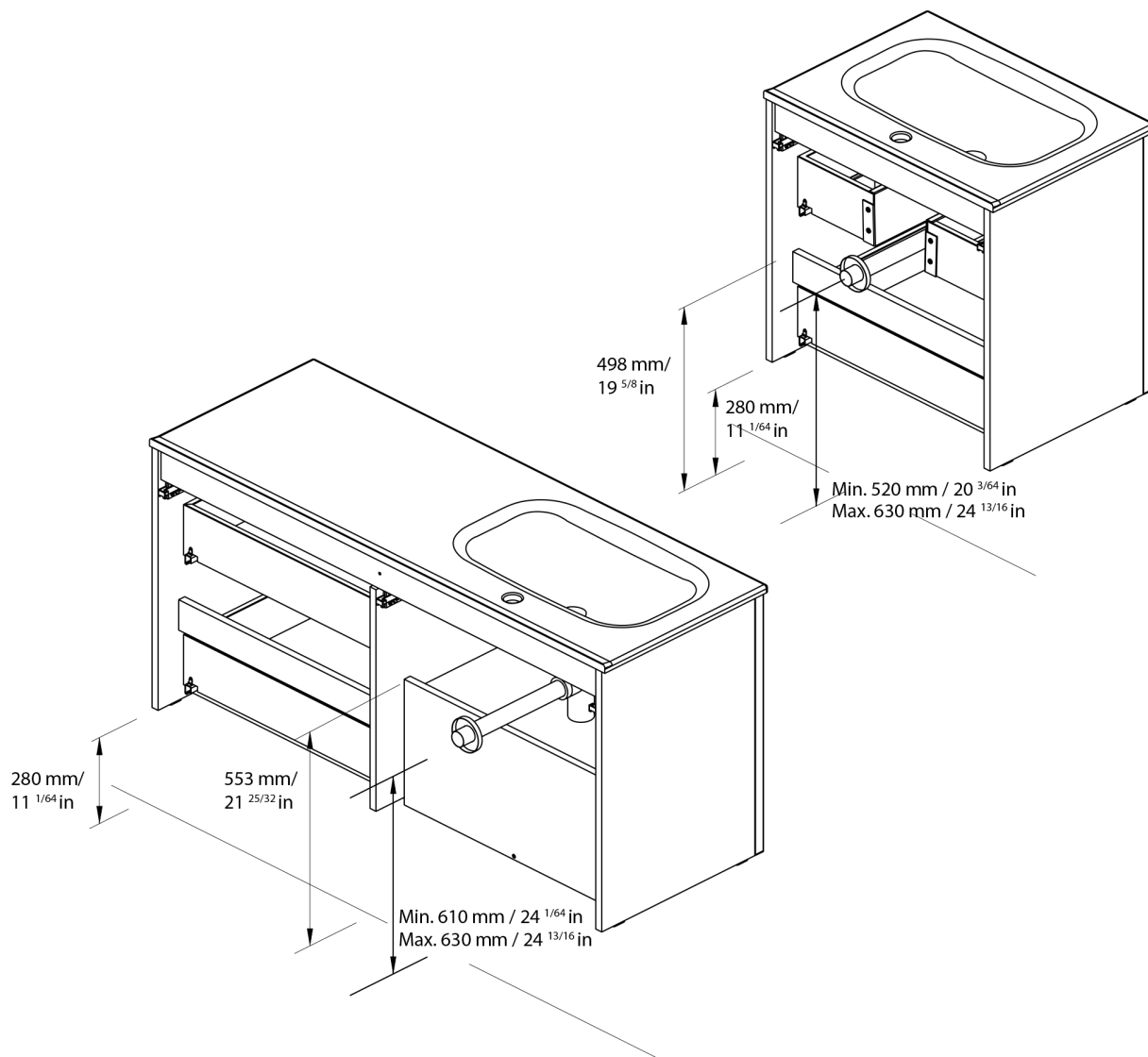

ES

EN

Las cotas indicadas en los dibujos son en función de la altura de la pata del conjunto, en caso de que el mueble vaya suspendido y esta altura no se respete, dichas cotas también variarán.

Dimensions indicated in the drawing are based on the level of the whole leg, in case of wall hanging the furniture dimensions also may vary.

Collection
Ambra

Model |
Ambra 80

Dimensions Metric

1 inch = 2.54 cm
1 inch = 25.4 mm

WS[®]

BATH
COLLECTIONS

1051 Lea Drive - Collegeville, PA 19426

Tel. 215 513 9400 - Fax 610 831 0215

www.ws bathcollections.com - info@ws bathcollections.com

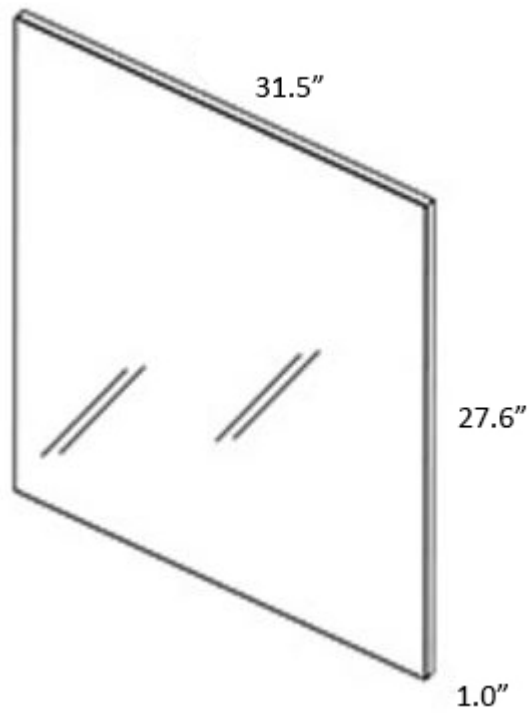

Collection
Murano

Model |
Murano 80

Dimensions Metric
1 inch = 2.54 cm
1 inch = 25.4 mm

WS[®]
BATH
COLLECTIONS

1051 Lea Drive - Collegeville, PA 19426
Tel. 215 513 9400 - Fax 610 831 0215
www.ws bathcollections.com - info@ws bathcollections.com

We recommend the following items that work with your sink.

Ambra 80 Pack 1

TRAPS



WSBC 53922
Our best seller

Polished Chrome
WSBC 53922.29

Matte Black
WSBC 53922.22



WSBC 5392

Polished Chrome
WSBC 5392.29



WSBC 53925

Polished Chrome
WSBC 53925.29



WSBC 53921
Space saving

Polished Chrome
WSBC 53921.29

Matte Black
WSBC 53921.22

DRAINS



WSBC 53991
Push waste drain (click clack)
with overflow

Polished Chrome
WSBC 53991.29

Matte Black
WSBC 53991.22

MOUNTING HARDWARE

Wall-mount installation

Vessel/ countertop installation



Bolts



Silicone (optional)

Collection
Ambra

Model |
Ambra 80 Pack 1

Dimensions Metric
1 inch = 2.54 cm
1 inch = 25.4 mm

WS[®]
BATH
COLLECTIONS

1051 Lea Drive - Collegeville, PA 19426
Tel. 215 513 9400 - Fax 610 831 0215

www.ws bathcollections.com - info@ws bathcollections.com