

# Product Specs Sheets

Cover Page

## Ambra 60F

### Features

- Complete Vanity Unit
- Available in 6 Finishes: Glossy White, Nordic Oak, Anthracite, Samara Ash, Matte White, and Matte Sand
- Free Standing Installation with Four Legs in Bright Chrome
- Two soft close drawers with organizer in upper drawer
- Includes integrated sink and vanity top in gloss white ceramic with faucet hole and overflow
- Fully assembled structure and front made of engineered wood in wood finishes and high gloss lacquered
- Handle integrated in front of furniture
- Hidden hanging bracket directly assembled with great resistance and depth regulations
- Made in Spain









### Related Items:

- WSBC 53991 | Push Waste Drain
- WSBC 53922 | Decorative Trap

### SKU# | Options

- Ambra 60F NO | Nordic Oak
- Ambra 60F SA | Samara Ash
- Ambra 60F WG | Glossy White
- Ambra 60F AN | Anthracite
- Ambra 60F WM | Matte White
- Ambra 60F SM | Matte Sand

### Finishes

-  Nordic Oak
-  Samara Ash
-  Glossy White
-  Anthracite
-  Matte White
-  Matte Sand

\* WS Bath Collections reserves the right to revise dimensions or information on this sheet without notice

<b>Collection</b> Ambra	<b>Model</b>   Ambra 60F	<b>Dimensions Metric</b> <i>1 inch = 2.54 cm</i> <i>1 inch = 25.4 mm</i>	 1051 Lea Drive - Collegeville, PA 19426 Tel. 215 513 9400 - Fax 610 831 0215 <a href="http://www.ws bathcollections.com">www.ws bathcollections.com</a> - <a href="mailto:info@ws bathcollections.com">info@ws bathcollections.com</a>
----------------------------	-----------------------------	--	---

## Technical features

Technical drawing	Name	Material	Colour	Colour
	<b>SLIM</b>			Gloss White
	<b>AMBRA</b> 2 Drawers			Nordic Oak
				Samara Ash
				Gloss White
				Anthracite
				Matte Sand
				Matte White
	<b>LEGS</b>			Chrome

## Technical information

STRUCTURE	MDF board in 5/8 in. continuous wrapping in 2D/ Cyclum Process.
FRONT	MDF board in 5/8 in. continuous wrapping in 2D/ Cyclum Process.
HANDLE	Integrated in the front of the furniture.
DRAWER	Drawers made in mokka textile poly laminate coated board with hidden partial extraction runners with soft close system. Lower drawer useful space (widthxheight): 20 1/16 x 4 5/16 x 12 2/4 in.
WALL HANGING BRACKET	Hidden hanging bracket of directly assembled with great resistance and depth regulations.
LEGS	Metallic in bright chrome finish. (optional)
PIPE DEPTH	Pipe depth 2 1/54 in.

Collection  
Ambra

Model |  
Ambra 60F

Dimensions Metric

1 inch = 2.54 cm  
1 inch = 25.4 mm

**WS**<sup>®</sup>  
BATH  
COLLECTIONS

1051 Lea Drive - Collegeville, PA 19426  
Tel. 215 513 9400 - Fax 610 831 0215

[www.ws bathcollections.com](http://www.ws bathcollections.com) - [info@ws bathcollections.com](mailto:info@ws bathcollections.com)

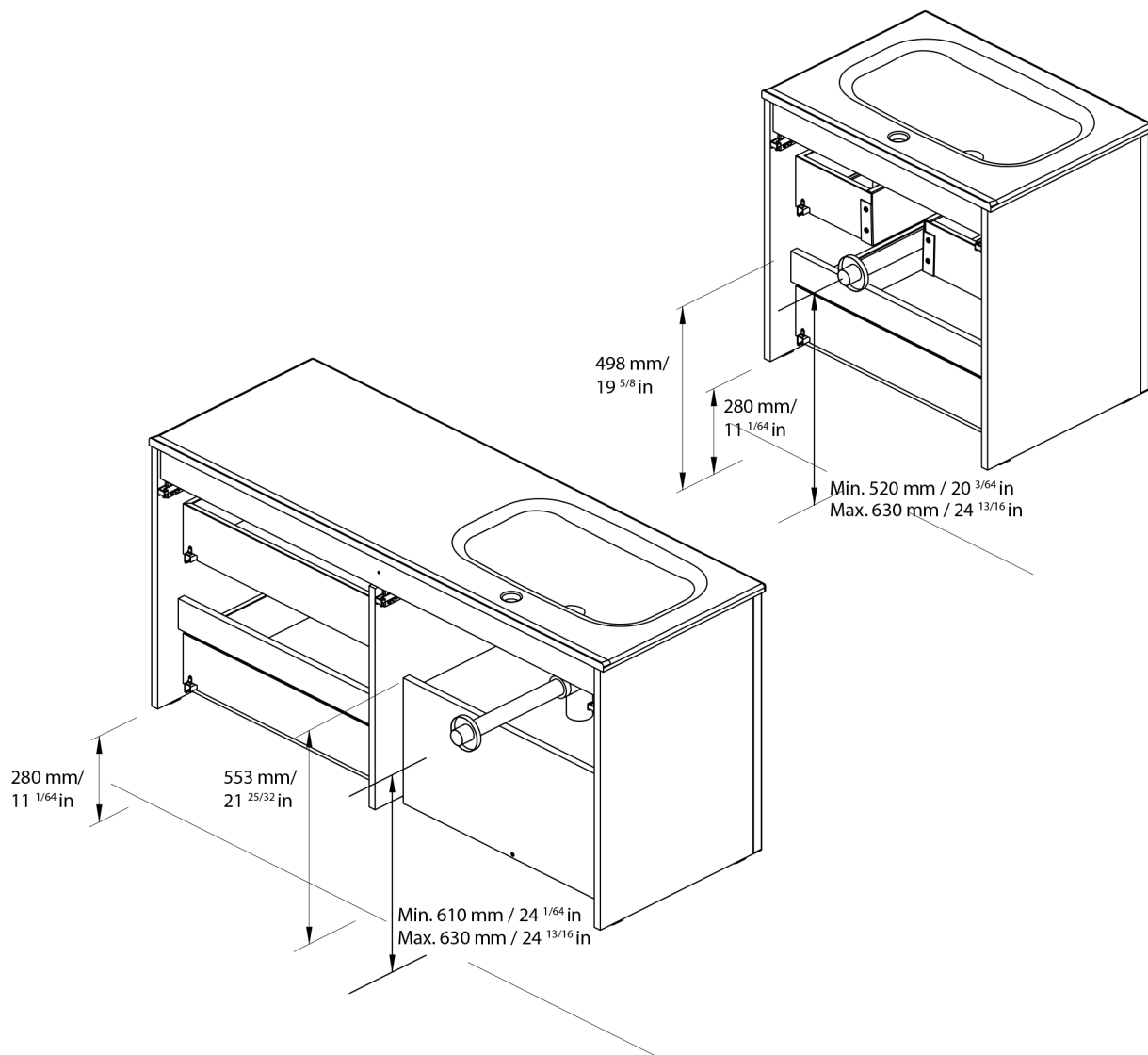

ES

EN

Las cotas indicadas en los dibujos son en función de la altura de la pata del conjunto, en caso de que el mueble vaya suspendido y esta altura no se respete, dichas cotas también variarán.

Dimensions indicated in the drawing are based on the level of the whole leg, in case of wall hanging the furniture dimensions also may vary.

Collection  
Ambra

Model |  
Ambra 60F

Dimensions Metric

1 inch = 2.54 cm  
1 inch = 25.4 mm

**WS**®

**BATH  
COLLECTIONS**

1051 Lea Drive - Collegeville, PA 19426

Tel. 215 513 9400 - Fax 610 831 0215

[www.ws bathcollections.com](http://www.ws bathcollections.com) - [info@ws bathcollections.com](mailto:info@ws bathcollections.com)

We recommend the following items that work with your sink.

Ambra 60F

## TRAPS



WSBC 53922  
*Our best seller*

Polished Chrome  
WSBC 53922.29

Matte Black  
WSBC 53922.22



WSBC 5392

Polished Chrome  
WSBC 5392.29



WSBC 53925

Polished Chrome  
WSBC 53925.29



WSBC 53921  
*Space saving*

Polished Chrome  
WSBC 53921.29

Matte Black  
WSBC 53921.22

## DRAINS



WSBC 53991  
Push waste drain (click clack)  
*with overflow*

Polished Chrome  
WSBC 53991.29

Matte Black  
WSBC 53991.22

## MOUNTING HARDWARE

### Wall-mount installation

### Vessel/ countertop installation



Bolts



Silicone (optional)

Collection  
Ambra

Model |  
Ambra 60F

Dimensions Metric  
*1 inch = 2.54 cm*  
*1 inch = 25.4 mm*

**WS**<sup>®</sup>  
**BATH**  
**COLLECTIONS**

1051 Lea Drive - Collegeville, PA 19426  
Tel. 215 513 9400 - Fax 610 831 0215  
[www.ws bathcollections.com](http://www.ws bathcollections.com) - [info@ws bathcollections.com](mailto:info@ws bathcollections.com)