

■ GEBERIT

*Duravit "Vero" toilet
with Geberit Monolith
in White Glass*

Geberit Product Catalog

February 2014

**KNOW
HOW
INSTALLED**

Table of Contents

Geberit North America is part of the Geberit Group, a European market leader and global provider of sanitary technology. Located in Des Plaines, Illinois, Geberit North America provides concealed tank and carrier systems for wall-hung and floor-mounted toilets and fixtures. Geberit systems improve the look of any bathroom by hiding the unsightly toilet tank. Replacing a standard tank and toilet with the Geberit system results in more usable space, improved hygiene and better accessibility. The unique dual-flush valve saves water and is practically maintenance free. Monolith is Geberit's newest product – a unique alternative to the traditional floor-mounted toilet and tank. Geberit also offers cable-controlled bath waste and overflows in a variety of designer finishes. Critical working parts are outside the waterway, ensuring years of trouble-free operation.

For more information, contact your Geberit sales representative, call 800/566-2100 or go to → geberit.us For more information, contact your Geberit sales representative, call 800/566-2100 or go to → geberit.us.

Geberit Installation Systems

Product features, installation scenarios, system components Page 3-5

Systems for Wall-Hung Toilets

Geberit Duofix Carrier with Sigma Concealed Tank, 2x6 Installations	6-7
Geberit Duofix Carrier with Sigma Concealed Tank, 2x4 Installations	8-9
Geberit Duofix Carrier with Kappa Concealed Tank, Pre-Wall Installations	10-11

Systems for Wall-Hung Urinals

Geberit Duofix Carrier, Actuators and Accessories, All Installations	12
--	----

Systems for Wall-Hung Bidets

Geberit Duofix Carrier, Actuators and Accessories, All Installations	13
--	----

Systems for Wall-Hung Lavatories

Geberit Duofix Carrier and Accessories, All Installations	14
---	----

Geberit Flushing System

Systems for Floor-Mounted, Back Outlet Toilets

Geberit Sigma Concealed Tank, Actuators and Accessories, 2x6 Installations	15-17
--	-------

Geberit Monolith

Systems for Floor-Mounted Back-Outlet Toilets

Geberit Monolith Module	20
-------------------------	----

System for Wall-Hung Toilets

Geberit Monolith Module	20
-------------------------	----

Geberit Bath Waste & Overflow Systems

Trim Finishes and Rough-In Unit Materials	22-23
Selecting the Right Size Bath Waste and Overflow	24-25

TurnControl BWO Systems

Geberit BWO Rough-in and Complete Units, Trim Kits and Accessories	26-28
--	-------

PushControl BWO Systems

Geberit BWO Complete Units and Accessories	29
--	----

TurnControl BWO Systems with Cascading Tub Fillers

Geberit BWO Complete Units and Accessories	29
--	----

Note for customers in Canada: To inquire about Geberit Bath Waste & Overflow Systems, contact Dobbin Sales at 905.264.5465 or info@dobbinsales.com. For all other Geberit products, go to our Locator at geberit.us.

Limited Warranty 30

Possession of this Catalog does not constitute an offer to sell Geberit product. Please refer to → geberit.us for our comprehensive terms and conditions.

Geberit Installation Systems

■ GEBERIT

Distinctive...Sustainable...Uncompromising

Geberit Installation Systems keep the unsightly out of sight.

Aesthetics

Safely hidden behind the wall, Geberit's in-wall technology allows unique beauty from floor to ceiling.

Water Saving

Geberit Dual-Flush Technology provides an effective flush volume of 1.1 GPF, exceeding the 1.28 GPF High Efficiency (HET) standard.

Space Saving

Design possibilities are realized with elegance when the toilet is off the floor. For confined spaces, it's the ideal choice.

Easy to Clean

Because the toilet is off the floor, cleaning the entire area is easy.

Flexibility

The adjustable-height carrier allows you to position the toilet 15" to 19" off the floor for meeting ADA requirements or personal preference.

Strength and Stability

The Geberit Installation System supports up to 880 lbs., exceeding ASME A112.6.2 strength requirements.

Accessible Maintenance

The Geberit Installation System offers easy access to all internal components, including the fill and flush valves, through decorative actuator flush panels. No tools are needed for simple changeouts.



Duravit "Starck 1" toilet with Sigma50 flush plate with Custom inlay

Installation Scenarios

Geberit Duofix Carriers are simple and easy to install. They require either a 2" x 4" or a 2" x 6" wood frame or metal frame construction. The studs must be placed 23-1/4" apart for 2" x 4" installation and 19-3/4" apart for 2" x 6" installation where the carrier will be positioned inside a wall. For pre-wall installations, frame to wall anchors are needed.

Wood frame in-wall installation, front activation.

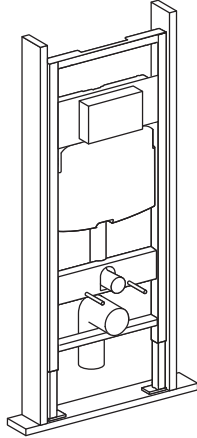

Metal frame in-wall installation, front activation.

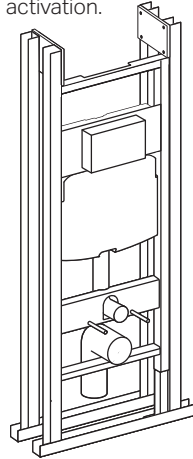

Pre-wall installation, front activation.

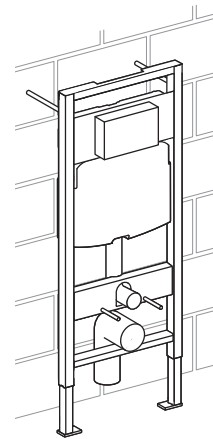

Pre-wall installation, top or front activation.

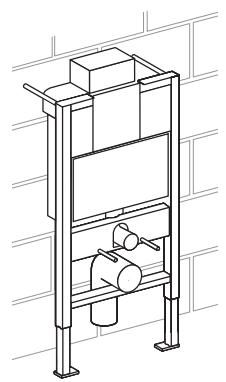

System Components

Toilet (See pages 6-11)

Geberit Duofix Carrier with Concealed Tank

Actuator

Fixture* (Not supplied)

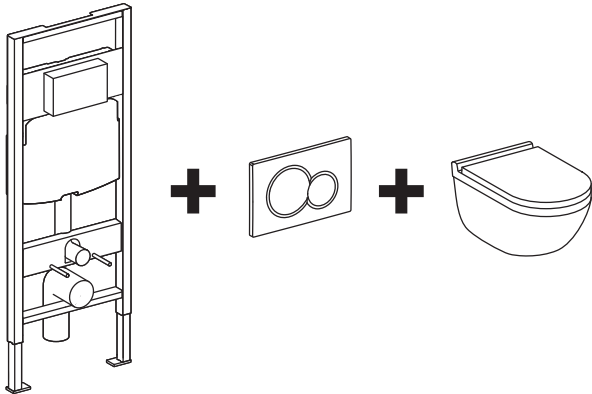

Urinal (See page 12)

Geberit Duofix Carrier

Actuator

Fixture* (Not supplied)

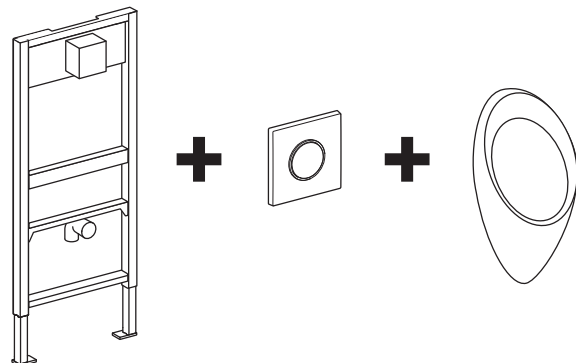

Bidet (See page 13)

Geberit Duofix Carrier

Fixture* (Not supplied)

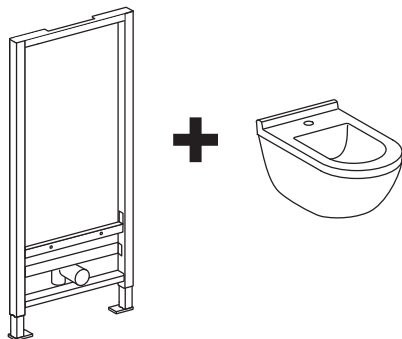

Lavatory (See page 14)

Geberit Duofix Carrier

Fixture* (Not supplied)

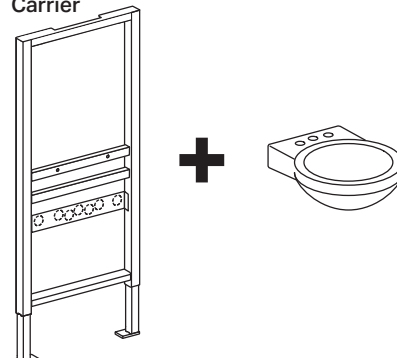







* Contact vitreous china manufacturer for complete selection of products. Refer to → geberit.us for recommended manufacturers.

Systems for Wall-Hung Toilets, 2x6 Installations



Dual-Flush Actuators

Dimensions: 9.75" x 6.5" (24.6 cm x 16.4 cm)

Style	Material	Finish	Model No.	List Price
	Plastic	Alpine White	115.777.11.1	\$110.00
		Polished Chrome	115.777.21.1	142.00
		Matte Chrome	115.777.46.1	142.00
	Plastic	Alpine White	115.770.11.5	81.00
		Polished Chrome	115.770.21.5	110.00
		Matte Chrome	115.770.46.5	110.00
		Star White	115.770.FR.5	81.00
		Sigma20	Metal	Br Ni-Polish-Br Ni*
Br SS-Polish-Br SS*	115.778.SN.1	226.00		
Br Ni-Polish-Br Ni* Vandal Resistant	115.781.ID.1	260.00		
Br SS-Polish-Br SS* Vandal Resistant	115.781.SN.1	260.00		
	Plastic	Polish-Matte-Polish*	115.778.KH.1	167.00
		White-Polish-White*	115.778.KJ.1	116.00
		Black-Polish-Black*	115.778.KM.1	143.00
	Die Cast	Customer supplied inlay	115.788.00.5	334.00
		Alpine White	115.788.11.5	334.00
		Black	115.788.DW.5	334.00
		Brushed Chrome	115.788.GH.5	431.00
		White Pattern Glass	115.788.SC.5	431.00
		Smoke Glass	115.788.SD.5	431.00
		Green Satin Glass	115.788.SE.5	431.00
		NEW Umber Glass	115.788.SQ.5	431.00
	Die Cast	Complete Rough-in and Trim Set	115.792.GH.1	556.00
		Rough-In Set***	115.795.21.1	167.00
		Brushed Chrome Trim Set***	115.796.GH.1	389.00
	Glass	Brushed SS	115.620.FW.1	625.00
		White Glass	115.620.SI.1	550.00
		Black Glass	115.620.SJ.1	550.00
		NEW Umber Glass	115.620.SQ.1	550.00



Single-Flush Actuators

Dimensions: 9.75" x 6.5" (24.6 cm x 16.4 cm)

	Die Cast	Alpine White	115.760.11.1	224.00
		Polished Chrome	115.760.21.1	224.00
		Matte Chrome	115.760.46.1	224.00
		Oil Rubbed Bronze	115.760.HM.1	378.00
		ForeverShine™ PVD Polished Nickel	115.760.IB.1	378.00
		ForeverShine™ PVD Brushed Nickel	115.760.ID.1	378.00
	Metal	Brushed Stainless with locking screw for vandal resistance	115.787.SN.5	260.00



Hands Free Actuators

Dimensions: 9.75" x 6.5" (24.6 cm x 16.4 cm)

	Metal	Brushed SS (AC Power)	115.890.SN.5	800.00
	Single Flush	Brushed SS (Battery/DC Power)	115.891.SN.5	800.00
	Glass	Black (AC Power)	116.090.SG.1	1,350.00
		Mirror (AC Power)	116.090.SM.1	1,350.00
		Transformer for AC powered hands free actuator.	115.861.00.1	132.00



Dual-Flush Push Buttons

Dimensions: Round – 3.25" (8 cm) diameter
 Square – 4.25" x 4.25" (10.8 cm x 10.8 cm)
 Rectangle – 5.06" x 2.91" (12.9 cm x 7.4 cm)

Style	Material	Finish	Model No.	List Price
	Plastic	Polished Chrome	115.999.21.1	\$143.00
		Alpine White	115.942.11.1	110.00
	Plastic	Polish-Matte**	115.942.KA.1	143.00
		Alpine White	115.942.11.1	110.00
	Plastic	Polish-Matte**	115.932.KA.1	143.00
	Metal	Brushed Chrome	115.932.GH.1	226.00

Single-Flush Push Buttons

Dimensions: Round – 2.5" (6.2 cm) diameter
 Square – 4.25" x 4.25" (10.8 cm x 10.8 cm)

	Plastic	Alpine White	115.114.11.1	94.00
		Polished Chrome	115.114.21.1	110.00
		Metal	Brushed SS	115.114.FW.1
	Plastic	Alpine White	115.941.11.1	94.00
		Polish-Matte**	115.941.KA.1	143.00

Cover Plates for Sigma concealed tank 2x6 and 2x4 for use with Push Buttons

	Die Cast	Alpine White	115.765.11.1	171.00
		Matte Chrome	115.765.46.1	171.00
		Metal	Brushed SS	115.798.00.1

Geberit Duofix Carrier

Model No.	Description	List Price
111.335.00.5	Carrier frame with Sigma concealed tank, 2x6 installations	519.00

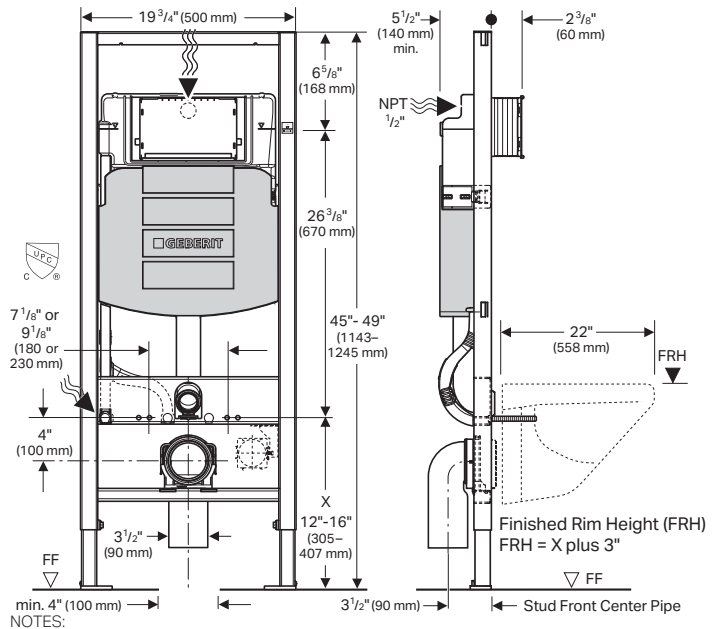





- NOTES:
1. Concealed tank shipped dual-flush ready
 2. Geberit Duofix Carrier for 2-hole washdown style wall-hung toilet fixtures only
 3. Refer to geberit.us for latest list of Code approved Compatible toilet fixtures, including certified WaterSense combinations



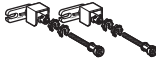

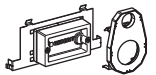
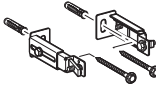
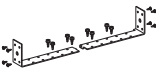

* Finishes follow this pattern = Plate-Ring-Button
 ** Finishes follow this pattern = Frame-Button
 Polish = Polished Chrome Br SS = Brushed Stainless Steel
 Matte = Matte Chrome Br Ni = Brushed Nickel
 *** Rough-in Set and Trim Set can be ordered separately. Both sets needed for installation.
 † Note: For tiled walls only!

Optional Accessories



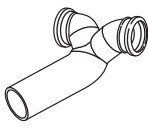

Mounting Accessories for Geberit Duofix Carrier Frames

Description	Model No.	List Price
 Frame to wall anchoring for 5.125"-7.875" (13-20 cm) thick unfinished pre-wall	111.815.00.1	\$31.00
 Frame to wall anchoring for 5.125"-7.875" (13-20 cm) thick unfinished pre-wall corner installations	111.835.00.1	31.00
 Support brackets for wall-hung toilets with small contact surface (thin profiles)	111.847.00.1	41.00
 Fire protection set for Sigma concealed tank 90 min. fire resistance to DIN EN 1364-1:1999-10	111.863.00.1	471.00
 Frame to wall anchoring where foot installations into floor are not allowed for 5.125"-7.875" (13-20 cm) thick unfinished pre-wall	111.867.00.1	62.00
 Frame to stud fastening set for extended stud spacing from 19.75"-25.56" (50-65 cm)	111.869.00.1	31.00
 Frame to wall anchoring extensions for 7.875"-15.75" (20-40 cm) thick unfinished pre-wall	111.887.00.1	12.00

Waste Fittings

 HDPE straight connector with socket for Ø3.50" (Ø90 mm) push fit piping and Ø3.50" (Ø90 mm) outlet x 12" (31 cm) long	366.887.16.1	31.00
 HDPE connector with offset for LH horizontal drain connections (as viewed from sitting position), 1 x 90° bend with socket for Ø3.50" (Ø90 mm) push fit piping, with 45° offset and Ø3.50" (Ø90 mm) outlet for 5.5" (13.97 cm) minimum walls only.	366.913.16.1	68.00
 HDPE connector with offset for RH horizontal drain connections (as viewed from sitting position), 1 x 90° bend with socket for Ø3.50" (Ø90 mm) push fit piping, with 45° offset and Ø3.50" (Ø90 mm) outlet for 5.5" (13.97 cm) minimum walls only.	366.914.16.1	68.00
 Cast iron outlet bend; 1 x 90° bend with socket for Ø3.50" (Ø90 mm) push fit piping and 3" CIP outlet	367.071.18.1	140.00
 HDPE "Back-to-back" connector for horizontal drain connections; 2 x 90° bends with sockets for Ø3.50" (Ø90 mm) push fit piping, with 45° offset and expansion to Ø4.375" (Ø110 mm) outlet for 10.75" (27.31 cm) minimum walls only.	367.485.16.1	140.00
 HDPE "Back-to-back" connector for vertical drain connections; 2 x 90° bends with sockets for Ø3.50" (Ø90 mm) push fit piping and expansion to Ø4.375" (Ø110 mm) outlet for 10.75" (27.31 cm) minimum walls only.	367.923.16.1	140.00



Bowl Connection Sets and Accessories for Finished Walls up to 3.5" (9 cm) Thick

Description	Model No.	List Price
 Connector set with mounting hardware (bowl installation kit), HDPE; Alpine White cover caps	152.404.11.1	39.00
 HDPE connection set with 1" (2.5 cm) offset and mounting hardware (bowl installation kit); with socket for Ø3.50" (Ø90 mm) push fit piping and Ø55 supply inlet; Matte Chrome cover caps	405.116.00.1	208.00
 Cover caps with leveling washer, Plastic, Alpine White	217.713.11.1	5.00
 Acoustic insulation set for wall-hung toilets and bidets	156.050.00.1	16.00

Bidet Seat Accessory for Geberit Duofix Carrier Frames

 Water supply hose for bidet seat for 111.355.00.5, 111.728.00.1 and 111.255.00.1 carriers with Sigma concealed tanks 2x6 and 2x4 and Kappa concealed tank. For adding bidet seat to an installed carrier.	249.801.00.1	101.00
---	--------------	--------

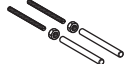

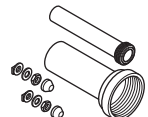



Required Accessories for 3.50"-7.00" (9-18 cm) Finished Wall Thickness

 Mounting rod extension set for wall-hung toilet and bidet, M12	242.232.00.1	61.00
 Mud guard protection housing for Sigma concealed tanks 2x6 and 2x4, Plastic	241.826.00.1	11.00
 Extension set for actuator plates for Sigma concealed tanks 2x6 and 2x4 and Kappa concealed tank	240.938.00.1	20.00
 HDPE Connector set for extended installation and mounting hardware (bowl installation kit), with socket for Ø3.50" (Ø90 mm) push fit piping and Ø55 supply inlet; Matte Chrome cover caps	152.438.46.1	51.00

Systems for Wall-Hung Toilets, 2x4 Installations



Dual-Flush Actuators

Dimensions: 9.75" x 6.5" (24.6 cm x 16.4 cm)

Style	Material	Finish	Model No.	List Price	
	Plastic	Alpine White	115.777.11.1	\$110.00	
		Polished Chrome	115.777.21.1	142.00	
		Matte Chrome	115.777.46.1	142.00	
	Plastic	Alpine White	115.770.11.5	81.00	
		Polished Chrome	115.770.21.5	110.00	
		Matte Chrome	115.770.46.5	110.00	
		Star White	115.770.FR.5	81.00	
		Br Ni-Polish-Br Ni*	115.778.ID.1	225.00	
	Metal	Br SS-Polish-Br SS*	115.778.SN.1	226.00	
		Br Ni-Polish-Br Ni* Vandal Resistant	115.781.ID.1	260.00	
		Br SS-Polish-Br SS* Vandal Resistant	115.781.SN.1	260.00	
		Plastic	Polish-Matte-Polish*	115.778.KH.1	167.00
	White-Polish-White*	115.778.KJ.1	116.00		
	Black-Polish-Black*	115.778.KM.1	143.00		
	NEW	Umbre Glass	115.788.SQ.5	431.00	
	Die Cast	Customer supplied inlay	115.788.00.5	334.00	
		Alpine White	115.788.11.5	334.00	
		Black	115.788.DW.5	334.00	
		Brushed Chrome	115.788.GH.5	431.00	
	Die Cast	White Pattern Glass	115.788.SC.5	431.00	
		Smoke Glass	115.788.SD.5	431.00	
		Green Satin Glass	115.788.SE.5	431.00	
		NEW	Umbre Glass	115.788.SQ.5	431.00
		Complete Rough-in and Trim Set	115.792.GH.1	556.00	
		Rough-In Set***	115.795.21.1	167.00	
	Glass	Brushed SS	115.625.FW.1	625.00	
		White Glass	115.625.SI.1	550.00	
		Black Glass	115.625.SJ.1	550.00	
		Umbre Glass	115.625.SQ.1	550.00	
		NEW	Umbre Glass	115.625.SQ.1	550.00

Single-Flush Actuators

Dimensions: 9.75" x 6.5" (24.6 cm x 16.4 cm)

	Die Cast	Alpine White	115.760.11.1	224.00
		Polished Chrome	115.760.21.1	224.00
		Matte Chrome	115.760.46.1	224.00
		Oil Rubbed Bronze	115.760.HM.1	378.00
		ForeverShine™ PVD Polished Nickel	115.760.IB.1	378.00
		ForeverShine™ PVD Brushed Nickel	115.760.ID.1	378.00
	Metal	Brushed Stainless with locking screw for vandal resistance	115.787.SN.5	260.00

Hands Free Actuators

Dimensions: 9.75" x 6.5" (24.6 cm x 16.4 cm)

	Glass	Black (AC Power)	116.091.SG.1	1,350.00
	Dual-Flush	Mirror (AC Power)	116.091.SM.1	1,350.00

	Transformer for AC powered hands free actuator.	115.861.00.1	132.00
--	---	--------------	--------

Single-Flush Push Buttons

Dimensions: Square – 4.25" x 4.25" (10.8 cm x 10.8 cm)

Style	Material	Finish	Model No.	List Price
	Plastic	Alpine White	115.991.11.1	94.00
		Polish-Matte**	115.991.KA.1	143.00

Cover Plates for Sigma concealed tank 2x6 and 2x4 for use with Push Buttons

	Die Cast	Alpine White	115.765.11.1	171.00
		Matte Chrome	115.765.46.1	171.00
	Metal	Brushed SS	115.798.00.1	135.00

Geberit Duofix Carrier

Model No.	Description	List Price
111.728.00.1	Carrier frame with Sigma concealed tank, 2x4 installations	\$646.00

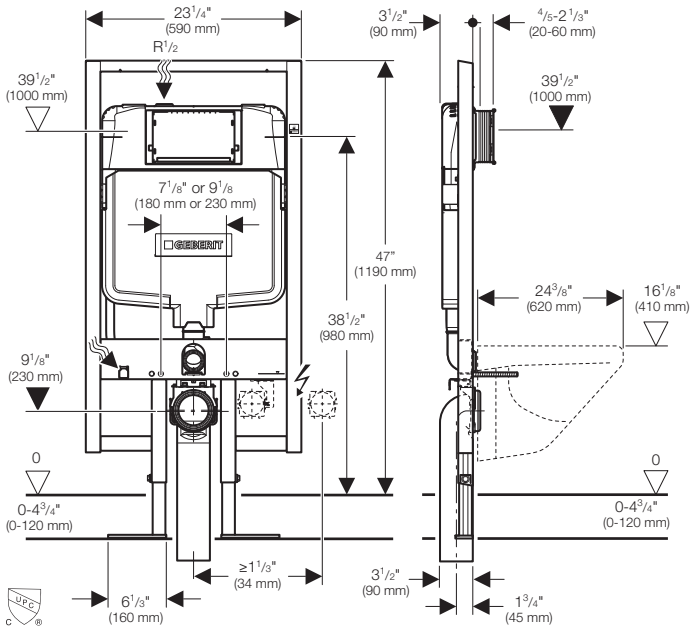

NOTES:

1. Concealed tank shipped dual-flush ready
2. Geberit Duofix Carrier for 2-hole washdown style wall-hung toilet fixtures only
3. Refer to → geberit.us for latest list of Code approved Compatible toilet fixtures, including certified WaterSense combinations

* Finishes follow this pattern = Plate-Ring-Button

** Finishes follow this pattern = Frame-Button

Polish = Polished Chrome

Matte = Matte Chrome

Br SS = Brushed Stainless Steel



Br Ni = Brushed Nickel

*** Rough-in Set and Trim Set can be ordered separately. Both sets needed for installation.





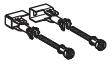
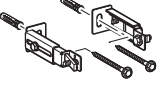

† Note: For tiled walls only!

Optional Accessories





Mounting Accessories for Geberit Duofix Carrier Frames

Description	Model No.	List Price
 Frame to wall anchoring for 5.125"-7.875" (13-20 cm) thick unfinished pre-wall corner installations	111.835.00.1	\$31.00
 Frame to wall anchoring where foot installations into floor are not allowed for 5.125"-7.875" (13-20 cm) thick unfinished pre-wall	111.867.00.1	62.00
 Frame to wall anchoring extensions for 7.875"-15.75" (20-40 cm) thick unfinished pre-wall	111.887.00.1	12.00
 Frame to wall anchoring for 5.125"-7.875" (13-20 cm) thick unfinished pre-wall	242.048.00.1	20.00



Waste Fittings

 HDPE straight connector with socket for 03.50" (090 mm) push fit piping and 03.50" (090 mm) outlet x 12" (31 cm) long	366.887.16.1	31.00
 HDPE connector with offset for LH horizontal drain connections (as viewed from sitting position), 1 x 90° bend with socket for 03.50" (090 mm) push fit piping, with 45° offset and 03.50" (090 mm) outlet for 5.5" (13.97 cm) minimum walls only.	366.913.16.1	68.00
 HDPE connector with offset for RH horizontal drain connections (as viewed from sitting position), 1 x 90° bend with socket for 03.50" (090 mm) push fit piping, with 45° offset and 03.50" (090 mm) outlet for 5.5" (13.97 cm) minimum walls only.	366.914.16.1	68.00
 Cast iron outlet bend; 1 x 90° bend with socket for 03.50" (090 mm) push fit piping and 3" CIP outlet	367.071.18.1	140.00
 HDPE "Back-to-back" connector for horizontal drain connections; 2 x 90° bends with sockets for 03.50" (090 mm) push fit piping, with 45° offset and expansion to 04.375" (0110 mm) outlet for 10.75" (27.31 cm) minimum walls only.	367.485.16.1	140.00
 HDPE "Back-to-back" connector for vertical drain connections; 2 x 90° bends with sockets for 03.50" (090 mm) push fit piping and expansion to 04.375" (0110 mm) outlet for 10.75" (27.31 cm) minimum walls only.	367.923.16.1	140.00



Bowl Connection Sets and Accessories for Finished Walls up to 3.5" (9cm) Thick

Description	Model No.	List Price
 Connector set with mounting hardware (bowl installation kit), HDPE; Alpine White cover caps	152.404.11.1	39.00
 HDPE connection set with 1" (2.5 cm) offset and mounting hardware (bowl installation kit); with socket for 03.50" (090 mm) push fit piping and 055 supply inlet; Matte Chrome cover caps	405.116.00.1	208.00
 Cover caps with leveling washer, Plastic, Alpine White	217.713.11.1	5.00
 Acoustic insulation set for wall-hung toilets and bidets	156.050.00.1	16.00

Bidet Seat Accessories for Geberit Duofix Carrier Frames

 Water supply hose for bidet seat for 111.728.00.1 carrier with Sigma concealed tanks 2x4. For adding bidet seat to an installed carrier. For complete installation order with 249.801.00.1.	242.413.00.1	43.00
 Water supply hose for bidet seat for 111.355.00.5, 111.728.00.1 and 111.255.00.1 carriers with Sigma concealed tanks 2x6 and 2x4 and Kappa concealed tank. For adding bidet seat to an installed carrier.	249.801.00.1	101.00

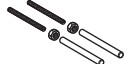
Required Accessories for 3.50"-7.00" (9-18 cm) Finished Wall Thickness

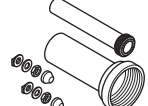
 Mounting rod extension set for wall-hung toilet and bidet, M12	242.232.00.1	61.00
 Mud guard protection housing for Sigma concealed tanks 2x6 and 2x4, Plastic	241.826.00.1	11.00
 Extension set for actuator plates for Sigma concealed tanks 2x6 and 2x4 and Kappa concealed tank	240.938.00.1	20.00
 HDPE Connector set for extended installation and mounting hardware (bowl installation kit), with socket for 03.50" (090 mm) push fit piping and 055 supply inlet; Matte Chrome cover caps	152.438.46.1	51.00

Systems for Wall-Hung Toilets, Pre-Wall Installations

Dual-Flush Actuators

Dimensions: 8.375" x 5.625" (21.1 cm x 14.2 cm)



Style	Material	Finish	Model No.	List Price
Kappa50	Metal	Brushed SS	115.258.00.1	\$229.00
	Die Cast	Alpine White	115.260.11.1	229.00
		Polished Chrome	115.260.21.1	229.00

Dual-Flush Push Buttons

Dimensions: Round – 3.25" (8 cm) diameter

Square – 4.25" x 4.25" (10.8 cm x 10.8 cm)

Rectangle – 5.06" x 2.91" (12.9 cm x 7.4 cm)

Style	Material	Finish	Model No.	List Price
Round	Plastic	Polished Chrome	115.999.21.1	\$143.00
	Plastic	Alpine White	115.942.11.1	110.00
		Polish-Matte**	115.942.KA.1	143.00
	Plastic	Polish-Matte**	115.932.KA.1	143.00
		Metal	Brushed Chrome	115.932.GH.1

Cover Plates for Kappa Concealed Tank Pre-wall for Use with Push Buttons

Style	Material	Finish	Model No.	List Price
	Plastic	Alpine White	115.680.11.1	\$85.00
		Polished Chrome	115.680.21.1	116.00

** Finishes follow this pattern = Frame-Button
 Polish = Polished Chrome
 Matte = Matte Chrome

Geberit Duofix Carrier

Model No.	Description	List Price
111.255.00.1	Carrier frame with Kappa concealed tank, pre-wall installations	\$557.00

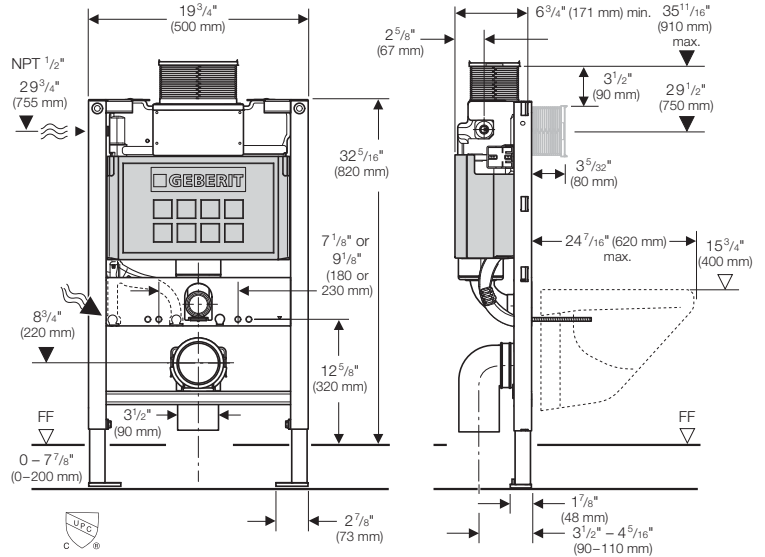





NOTES:



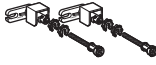

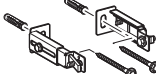
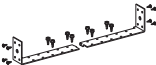

1. Concealed tank shipped dual-flush ready
2. Carrier for 2-hole washdown style wall-hung toilet fixtures only
3. Refer to [geberit.us](https://www.geberit.us) for latest list of code approved compatible toilet fixtures, including certified WaterSense combinations

Optional Accessories





Mounting Accessories for Geberit Duofix Carrier Frames

Description	Model No.	List Price
 Frame to wall anchoring for 5.125"-7.875" (13-20 cm) thick unfinished pre-wall	111.815.00.1	\$31.00
 Frame to wall anchoring for 5.125"-7.875" (13-20 cm) thick unfinished pre-wall corner installations	111.835.00.1	31.00
 Support brackets for wall-hung toilets with small contact surface (thin profiles)	111.847.00.1	41.00
 Frame to wall anchoring where foot installations into floor are not allowed for 5.125"-7.875" (13-20 cm) thick unfinished pre-wall	111.867.00.1	62.00
 Frame to stud fastening set for extended stud spacing from 19.75"-25.56" (50-65 cm)	111.869.00.1	31.00
 Frame to wall anchoring extensions for 7.875"-15.75" (20-40 cm) thick unfinished pre-wall	111.887.00.1	12.00



Waste Fittings

 HDPE straight connector with socket for Ø3.50" (Ø90 mm) push fit piping and Ø3.50" (Ø90 mm) outlet x 12" (31 cm) long	366.887.16.1	31.00
 HDPE connector with offset for LH horizontal drain connections (as viewed from sitting position), 1 x 90° bend with socket for Ø3.50" (Ø90 mm) push fit piping, with 45° offset and Ø3.50" (Ø90 mm) outlet for 5.5" (13.97 cm) minimum walls only.	366.913.16.1	68.00
 HDPE connector with offset for RH horizontal drain connections (as viewed from sitting position), 1 x 90° bend with socket for Ø3.50" (Ø90 mm) push fit piping, with 45° offset and Ø3.50" (Ø90 mm) outlet for 5.5" (13.97 cm) minimum walls only.	366.914.16.1	68.00
 Cast iron outlet bend; 1 x 90° bend with socket for Ø3.50" (Ø90 mm) push fit piping and 3" CIP outlet	367.071.18.1	140.00
 HDPE "Back-to-back" connector for horizontal drain connections; 2 x 90° bends with sockets for Ø3.50" (Ø90 mm) push fit piping, with 45° offset and expansion to Ø4.375" (Ø110 mm) outlet for 10.75" (27.31 cm) minimum walls only.	367.485.16.1	140.00
 HDPE "Back-to-back" connector for vertical drain connections; 2 x 90° bends with sockets for Ø3.50" (Ø90 mm) push fit piping and expansion to Ø4.375" (Ø110 mm) outlet for 10.75" (27.31 cm) minimum walls only.	367.923.16.1	140.00

Bowl Connection Sets and Accessories for Finished Walls up to 3.5" (9 cm) Thick

Description	Model No.	List Price
 Connector set with mounting hardware (bowl installation kit), HDPE; Alpine White cover caps	152.404.11.1	39.00
 HDPE connection set with 1" (2.5 cm) offset and mounting hardware (bowl installation kit); with socket for Ø3.50" (Ø90 mm) push fit piping and Ø55 supply inlet; Matte Chrome cover caps	405.116.00.1	\$208.00
 Cover caps with leveling washer, Plastic, Alpine White	217.713.11.1	5.00
 Acoustic insulation set for wall-hung toilets and bidets	156.050.00.1	16.00

Bidet Seat Accessory for Geberit Duofix Carrier Frames

 Water supply hose for bidet seat for 111.255.00.1 carrier with Kappa concealed tank pre-wall. For adding bidet seat to an installed carrier. For complete installation order with 249.801.00.1.	240.839.00.1	52.00
 Water supply hose for bidet seat for 111.355.00.5, 111.728.00.1 and 111.255.00.1 carriers with Sigma concealed tanks 2x6 and 2x4 and Kappa concealed tank. For adding bidet seat to an installed carrier.	249.801.00.1	101.00

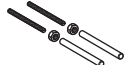
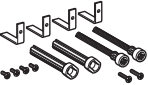
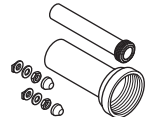

Required Accessories for 3.50"-7.00" (9-18 cm) Finished Wall Thickness

 Mounting rod extension set for wall-hung toilet and bidet, M12	242.232.00.1	61.00
 Extension set for actuator plates for Sigma concealed tanks 2x6 and 2x4 and Kappa concealed tank	240.938.00.1	20.00
 HDPE Connector set for extended installation and mounting hardware (bowl installation kit), with socket for Ø3.50" (Ø90 mm) push fit piping and Ø55 supply inlet; Matte Chrome cover caps	152.438.46.1	51.00

Systems for Wall-Hung Urinals

Actuators

Dimensions: Square – 5.125" x 5.125" (13 cm x 13 cm)

Style	Material	Finish	Model No.	List Price
 NEW	Die Cast	Customer supplied inlay	116.016.00.5	\$506.00
		Alpine White	116.016.11.5	506.00
		Brushed Chrome	116.016.GH.5	700.00
 NEW	Metal	Brushed SS	116.015.SN.1	345.00
	Plastic	Alpine White	116.012.11.1	299.00
		Polished Chrome	116.012.21.1	299.00

Hands Free Actuators

Dimensions: Square – 5.125" x 5.125" (13 cm x 13 cm)

 NEW	Metal	Brushed SS (Battery/DC Power)	116.035.SN.1	800.00
		Brushed SS (AC Power – CLASS 2 power supply transformer included)	116.025.SN.1	800.00

Geberit Duofix Carrier



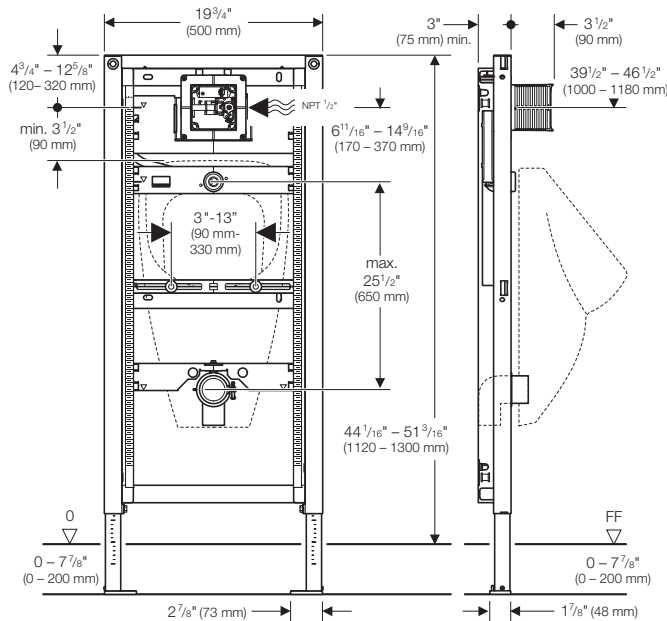

Model No.	Description	List Price
111.625.00.1	Carrier frame with rough-in box	\$557.00



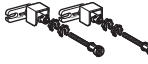

- NOTES:
- Carrier for 2-hole "Euro" style wall-hung urinal fixtures only
 - ASSE 1001 Certified Atmospheric Vacuum Breaker included.
 - Refer to → geberit.us for latest list of Code approved Compatible urinal fixtures

Optional Accessories



Mounting Accessories for Geberit Duofix Carrier Frames

Description	Model No.	List Price
 Frame to wall anchoring for 5.125"-7.875" (13-20 cm) thick unfinished pre-wall	111.815.00.1	\$31.00
 Frame to wall anchoring for 5.125"-7.875" (13-20 cm) thick unfinished pre-wall corner installations	111.835.00.1	31.00
 Frame to wall anchoring where foot installations into floor are not allowed for 5.125"-7.875" (13-20 cm) thick unfinished pre-wall	111.867.00.1	62.00
 Frame to stud fastening set for extended stud spacing from 19.75"-25.56" (50-65 cm)	111.869.00.1	31.00
 Frame to wall anchoring extensions for 7.875"-15.75" (20-40 cm) thick unfinished pre-wall	111.887.00.1	12.00

Urinal Connection Sets and Accessories

 PE syphon trap with horizontal outlet and seal; Ø1.96" (Ø50 mm) outlet	152.983.00.1	32.00
 PE syphon trap with vertical outlet and seal; Ø1.97" (Ø50 mm) outlet	152.984.00.1	32.00

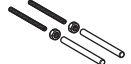
Required Accessories for 3.50"-7.00" (9-18 cm) Finished Wall Thickness

 Mounting rod extension set for wall-hung urinal, M8	242.318.00.1	41.00
 Mud guard protection housing and extension set for urinal carrier	241.930.00.1	17.00

Systems for Wall-Hung Bidets

Geberit Duofix Carrier

Model No.	Description	List Price
111.520.00.1	Carrier frame, standard height	\$557.00

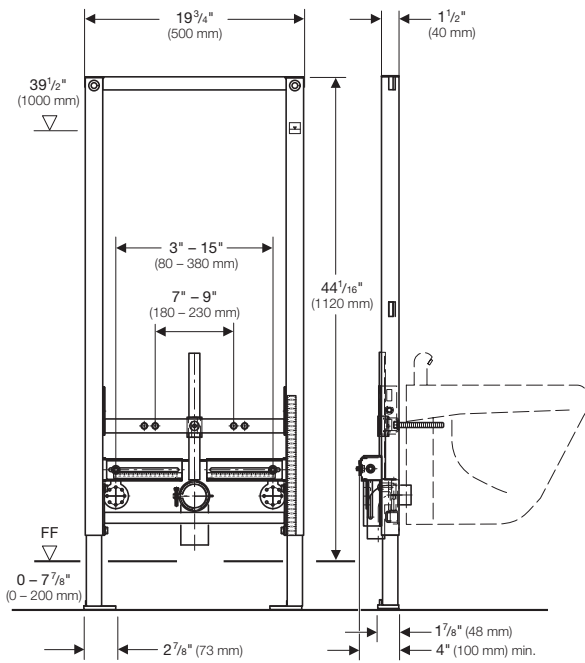

Model No.	Description	List Price
111.524.00.1	Carrier frame, short height (matches 111.255.00.1)	\$557.00

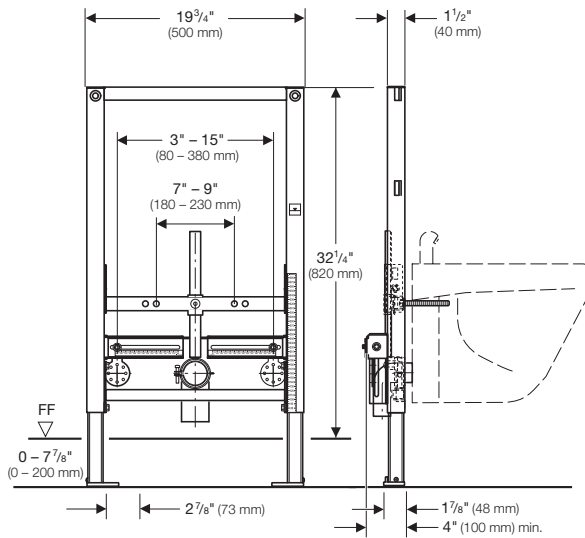

- NOTES:
1. Geberit Duofix Carrier for 2-hole wall-hung bidet fixtures only
 2. Refer to → geberit.us for latest list of Code approved Compatible bidet fixtures

Optional Accessories

Mounting Accessories for Geberit Duofix Carrier Frames		Model No.	List Price
--	--	-----------	------------

	Frame to wall anchoring for 5.125"-7.875" (13-20 cm) thick unfinished pre-wall	111.815.00.1	\$31.00
	Frame to wall anchoring for 5.125"-7.875" (13-20 cm) thick unfinished pre-wall corner installations	111.835.00.1	31.00
	Frame to wall anchoring where foot installations into floor are not allowed for 5.125"-7.875" (13-20 cm) thick unfinished pre-wall	111.867.00.1	62.00
	Frame to stud fastening set for extended stud spacing from 19.75"-25.56" (50-65 cm)	111.869.00.1	31.00
	Frame to wall anchoring extensions for 7.875"-15.75" (20-40 cm) thick unfinished pre-wall	111.887.00.1	12.00
	Elbow supply fitting set, Gun Metal	465.034.00.1	34.00

Bowl Connection Accessories

	Acoustic insulation set for wall-hung toilets and bidets	156.050.00.1	16.00
	Cover caps with leveling washer, Plastic, Alpine White	217.713.11.1	5.00

Required Accessories for 3.50"-7.00" (9-18 cm) Finished Wall Thickness

	Mounting rod extension set for wall-hung toilet and bidet, M12	242.232.00.1	61.00
--	--	--------------	-------

Systems for Wall-Hung Lavatories

Geberit Duofix Carrier



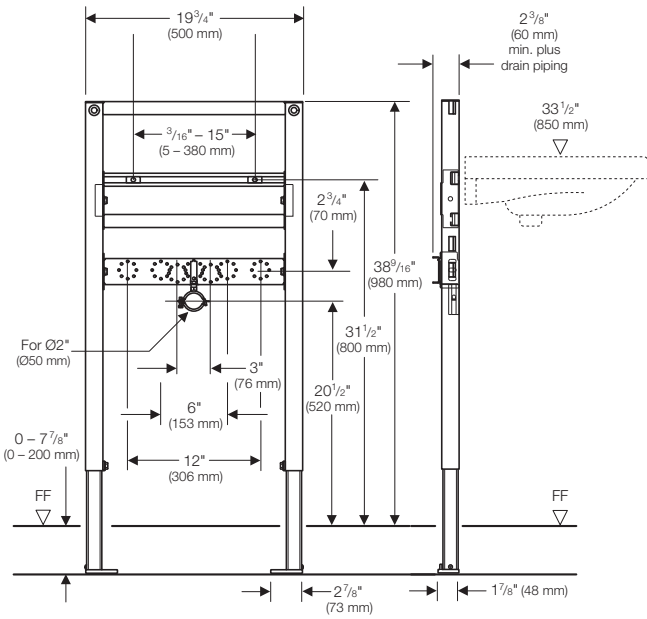



Model No.	Description	List Price
111.490.00.1	Carrier frame, short height (matches 111.255.00.1)	\$307.00

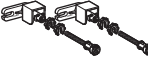

- NOTES:
1. Geberit Duofix Carrier for 2-hole wall-hung lavatory fixtures only
 2. Refer to → geberit.us for latest list of Code approved Compatible lavatory fixtures

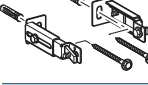
Optional Accessories

Mounting Accessories for Geberit Duofix Carrier Frames

Description	Model No.	List Price
 Frame to wall anchoring for 5.125"-7.875" (13-20 cm) thick unfinished pre-wall	111.815.00.1	\$31.00
 Frame to wall anchoring for 5.125"-7.875" (13-20 cm) thick unfinished pre-wall corner installations	111.835.00.1	31.00
 Frame to wall anchoring where foot installations into floor are not allowed for 5.125"-7.875" (13-20 cm) thick unfinished pre-wall	111.867.00.1	62.00
 Fastening set for sinks with 14.9"-22.8" (38-58 cm) mounting centers	111.868.00.1	105.00
 Frame to stud fastening set for extended stud spacing from 19.75"-25.56" (50-65 cm)	111.869.00.1	31.00
 Frame to wall anchoring extensions for 7.875"-15.75" (20-40 cm) thick unfinished pre-wall	111.887.00.1	12.00
 Elbow supply fitting set, Gun Metal	465.034.00.1	34.00

Lavatory Connection Accessories

 Cover caps with leveling washer, Plastic, Alpine White	217.713.11.1	5.00
---	--------------	------

Required Accessories for 3.50"-7.00" (9-18 cm) Finished Wall Thickness

 Mounting rod extension set for wall-hung lavatory, M10	242.233.00.1	41.00
--	--------------	-------

Geberit Flushing System



Safely hidden behind the wall, Geberit's in-wall technology creates clean lines to show unique beauty from floor to ceiling. The concealed tank with actuator in-wall technology enables plumbing fixtures to be mounted without the cumbersome tank – providing a clean, refined look that enhances design.







“Behind-the-wall” does not mean “out of reach.” The fill and flush valves and the supply stop are hidden from sight, yet these components are easily accessible through elegant actuator flush panels from Geberit for tool-free maintenance.

Available in single- and dual-flush options.

Geberit Concealed Tank for Floor Mounted, Back Outlet, 2x6 Installations



Dual-Flush Actuators

Dimensions: 9.75" x 6.5" (24.6 cm x 16.4 cm)

Style	Material	Finish	Model No.	List Price
	Plastic	Alpine White	115.777.11.1	\$110.00
		Polished Chrome	115.777.21.1	142.00
		Matte Chrome	115.777.46.1	142.00
	Plastic	Alpine White	115.770.11.5	81.00
		Polished Chrome	115.770.21.5	110.00
		Matte Chrome	115.770.46.5	110.00
		Star White	115.770.FR.5	81.00
	Metal	Br Ni-Polish-Br Ni*	115.778.ID.1	225.00
		Br SS-Polish-Br SS*	115.778.SN.1	226.00
		Br Ni-Polish-Br Ni* Vandal Resistant	115.781.ID.1	260.00
		Br SS-Polish-Br SS* Vandal Resistant	115.781.SN.1	260.00
	Plastic	Polish-Matte-Polish*	115.778.KH.1	167.00
		White-Polish-White*	115.778.KJ.1	116.00
		Black-Polish-Black*	115.778.KM.1	143.00
	Die Cast	Customer supplied inlay	115.788.00.5	334.00
		Alpine White	115.788.11.5	334.00
		Black	115.788.DW.5	334.00
		Brushed Chrome	115.788.GH.5	431.00
		White Pattern Glass	115.788.SC.5	431.00
		Smoke Glass	115.788.SD.5	431.00
		Green Satin Glass	115.788.SE.5	431.00
		NEW Umber Glass	115.788.SQ.5	431.00
	Die Cast	Complete Rough-in and Trim Set	115.792.GH.1	556.00
		Rough-In Set***	115.795.21.1	167.00
		Brushed Chrome Trim Set***	115.796.GH.1	389.00
	Glass	Brushed SS	115.620.FW.1	625.00
		White Glass	115.620.SI.1	550.00
		Black Glass	115.620.SJ.1	550.00
		Umber Glass	115.620.SQ.1	550.00



Single-Flush Actuators

Dimensions: 9.75" x 6.5" (24.6 cm x 16.4 cm)

	Die Cast	Alpine White	115.760.11.1	224.00
		Polished Chrome	115.760.21.1	224.00
		Matte Chrome	115.760.46.1	224.00
		Oil Rubbed Bronze	115.760.HM.1	378.00
		ForeverShine™ PVD Polished Nickel	115.760.IB.1	378.00
		ForeverShine™ PVD Brushed Nickel	115.760.ID.1	378.00
	Metal	Brushed Stainless with locking screw for vandal resistance	115.787.SN.5	260.00



Hands Free Actuators

Dimensions: 9.75" x 6.5" (24.6 cm x 16.4 cm)

	Metal	Brushed SS (AC Power)	115.890.SN.5	800.00
		Brushed SS (Battery/DC Power)	115.891.SN.5	800.00
	Glass	Black (AC Power)	116.090.SG.1	1,350.00
		Mirror (AC Power)	116.090.SM.1	1,350.00
		Transformer for AC powered hands free actuator.	115.861.00.1	132.00



Dual-Flush Push Buttons

Dimensions: Round – 3.25" (8 cm) diameter
 Square – 4.25" x 4.25" (10.8 cm x 10.8 cm)
 Rectangle – 5.06" x 2.91" (12.9 cm x 7.4 cm)

Style	Material	Finish	Model No.	List Price
	Plastic	Polished Chrome	115.999.21.1	\$143.00
	Plastic	Alpine White	115.942.11.1	110.00
		Polish-Matte**	115.942.KA.1	143.00
	Plastic	Polish-Matte**	115.932.KA.1	143.00
	Metal	Brushed Chrome	115.932.GH.1	226.00

Single-Flush Push Buttons

Dimensions: Round – 2.5" (6.2 cm) diameter
 Square – 4.25" x 4.25" (10.8 cm x 10.8 cm)

	Plastic	Alpine White	115.114.11.1	94.00
		Polished Chrome	115.114.21.1	110.00
		Metal	Brushed SS	115.114.FW.1
	Plastic	Alpine White	115.941.11.1	94.00
		Polish-Matte**	115.941.KA.1	143.00

Cover Plates for Sigma concealed tank 2x6 and 2x4 for use with Push Buttons

	Die Cast	Alpine White	115.765.11.1	171.00
		Matte Chrome	115.765.46.1	171.00
		Metal	Brushed SS	115.798.00.1

Concealed Tank

Model No.	Description	List Price
109.304.00.5	Sigma concealed tank 2x6 installations	\$374.00

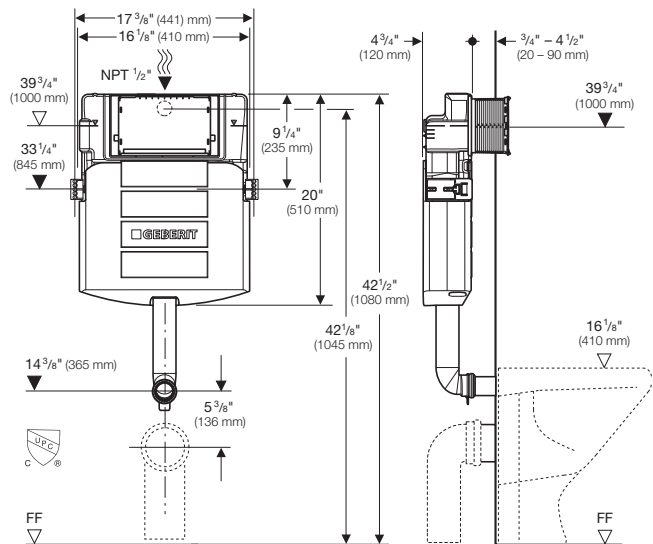

- NOTES:
1. Concealed tank shipped dual-flush ready
 2. Tank for floor-mounted, back outlet washdown style toilet fixtures only
 3. Refer to → geberit.us for latest list of code approved compatible toilet fixtures, including certified WaterSense combinations

* Finishes follow this pattern = Plate-Ring-Button
 ** Finishes follow this pattern = Frame-Button
 Polish = Polished Chrome Br SS = Brushed Stainless Steel
 Matte = Matte Chrome Br Ni = Brushed Nickel

*** Rough-in Set and Trim Set can be ordered separately. Both sets needed for installation.
 † Note: For tiled walls only!

Optional Accessories



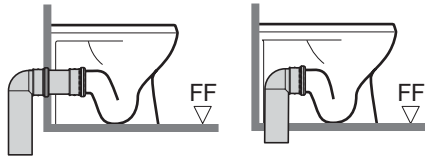



Waste Fitting Discharge Configurations



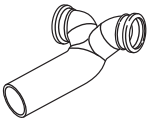

A. Floor-Mount Rear Discharge into Wall

B. Floor-Mount Rear Discharge into Floor

Waste Fittings (Note: Mounting collar/clamp by installer)

Description	Model No.	List Price
 (For A discharge)	366.061.16.1	\$20.00
 (For A discharge)	366.913.16.1	68.00
 (For A discharge)	366.914.16.1	68.00
 (For A discharge)	367.071.18.1	140.00
 (For A discharge)	367.485.16.1	140.00
 (For A discharge)	367.923.16.1	140.00
 (For A or B discharge)	152.647.00.1	105.00

Required Accessories for 3.50\"–7.00\" (9–18 cm) Finished Wall Thickness

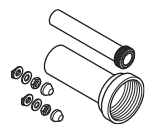
	Mud guard protection housing for Sigma concealed tanks 2x6 and 2x4, Plastic	241.826.00.1	\$11.00
	Extension set for actuator plates for Sigma concealed tanks 2x6 and 2x4 and Kappa concealed tank	240.938.00.1	20.00
	HDPE Connector set for extended installation and mounting hardware (bowl installation kit), with socket for Ø3.50\" (Ø90 mm) push fit piping and Ø2.16\" (Ø55 mm) supply inlet; Matte Chrome cover caps	152.438.46.1	51.00

Geberit Monolith

GEBERIT MONOLITH

*Duravit "Starck 3" toilet
with Geberit Monolith
in White Glass*

Geberit Monolith radically alters the look of the toilet tank while offering all the advantages of Geberit in-wall systems. As a slim and attractive alternative to a typical toilet tank, Geberit Monolith is secured to the wall and can be adapted to any bathroom or powder room.

Showcasing the latest water-conserving technology, Geberit Monolith uses a dual-flush mechanism that is built into the top of the housing. The system's large and small levers offer two water-saving flush choices: 1.6 GPF (6 LPF) and 0.8 GPF (3 LPF), respectively.

The Geberit Monolith modular structure is made of high-quality materials, and is available with black or white tempered glass. All valves are easily accessible for simple maintenance. The Geberit Monolith housing hides the toilet tank, as well as the fill and flush valves, for a sleek, modern look.



*Catalano "Verso" toilet
with Geberit Monolith in
Black Glass*

System for Floor-Mount Toilets

Geberit Monolith

Model Number	Description	List Price
131.144.SF.1	Geberit Monolith for floor-mounted toilets, White Glass with Duravit Starck 3 WC and Seat/Lid	\$1,244.00
131.144.SG.1	Geberit Monolith for floor-mounted toilets, Black Glass with Duravit Starck 3 WC and Seat/Lid	1,244.00

Consists of:

- (1) Geberit Monolith 131.126.xx.1 (SF=white; SG=black)
- (1) Geberit Toilet Outlet 131.127.29.1
- (1) Duravit Starck 3 Floor Mounted Elongated Toilet, White 131.128.11.1 (Duravit 215809)
- (1) Soft Close Seat and Lid for Duravit Starck 3 131.142.11.1 (Duravit 006339)

131.145.SF.1	Geberit Monolith for floor-mounted toilets, White Glass with Outlet	525.00
--------------	---	--------

131.145.SG.1	Geberit Monolith for floor-mounted toilets, Black Glass with Outlet	525.00
--------------	---	--------

Consists of:

- (1) Geberit Monolith 131.126.xx.1 (SF=white; SG=black)
- (1) Geberit Toilet Outlet 131.127.29.1
- Mates with Duravit Starck 3 Floor Mounted Elongated Toilet, White 215809 (sold separately) Contact Duravit.
- Mates with any Seat and Lid for Duravit Starck 3 Elongated (sold separately) Contact Duravit.

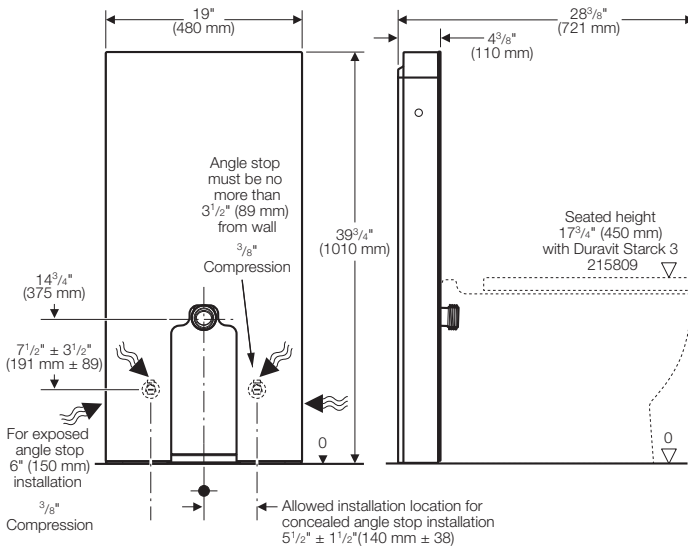

System for Wall-Hung Toilets

Geberit Monolith

Model No.	Description	List Price
131.028.SI.1	Geberit Monolith for wall-hung toilets, White Glass	\$1,298.00
131.028.SJ.1	Geberit Monolith for wall-hung toilets, Black Glass	1,298.00

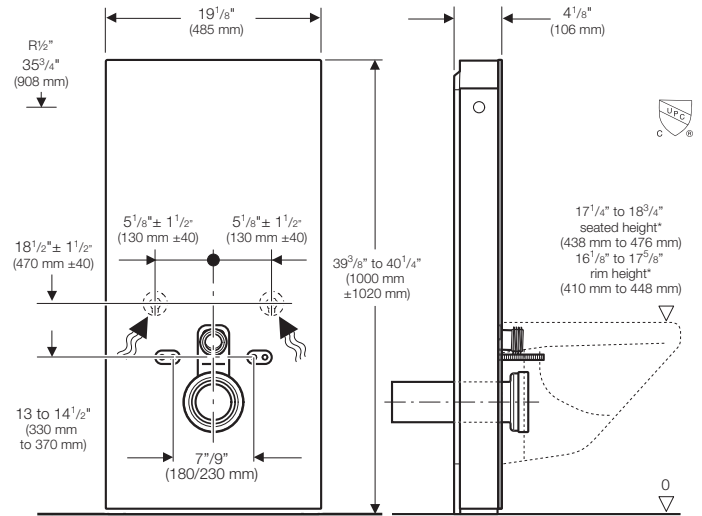

NOTES:

1. Concealed tank shipped dual-flush ready
2. Geberit Monolith for 2-hole washdown style wall-hung toilet fixtures only
3. Refer to geberit.us for latest list of code approved compatible toilet fixtures, including certified WaterSense combinations

Optional Accessories

Mounting Accessories for Geberit Monolith

Description	Model No.	List Price
Support brackets for wall-hung toilets with small contact surface (thin profiles)	131.105.00.1	\$41.00

Bowl Connection Sets and Accessories

PP connection set with 1" (2.5 cm) offset and socket for Ø3.50" (Ø90 mm) push fit piping. Order with 405.116.00.1 for hardware (bowl installation kit) and Ø55 offset supply inlet.	131.085.00.1	18.00
HDPE connection set with 1" (2.5 cm) offset and mounting hardware (bowl installation kit); with socket for Ø3.50" (Ø90 mm) push fit piping and Ø55 supply inlet; Matte Chrome cover caps	405.116.00.1	208.00

Geberit Bath Waste & Overflow Systems



Trim Finishes and Rough-In Unit Materials

It's Geberit It's Cable-Operated

Unlike other styles of bath drains, the Geberit Bath Waste & Overflow (BWO) critical working parts are outside the waterway and away from the flow of water to prevent clogging. The high quality cable is crafted from Teflon® coated stainless steel and has a plastic sleeve to deliver years of trouble-free service.

Note for customers in Canada: To inquire about Geberit Bath Waste & Overflow Systems, contact Dobbin Sales at 905.264.5465 or info@dobbinsales.com. For all other Geberit products, go to our Locator at geberit.us.

Styles to Meet Your Needs

PushControl BWO

The Geberit PushControl BWO offers a thin, elegant look.

Traditional TurnControl BWO

The Geberit "original" was first-to-market over 25 years ago.

Cascading Tub Filler BWO

An integrated system that combines the functionality of filling and draining into one component.

Euro TurnControl BWO

Stylish with a distinctive contour, the Geberit Euro TurnControl BWO delivers.



Selecting a trim finish

The distinctive contoured handles are offered in a wide variety of finishes to match almost any décor. ForeverShine™ finishes have been developed to ensure that the quality and look of the product on which it is applied will last a lifetime. Clean up is simple and requires no abrasive cleansers or chemicals so maintaining the initial factory finish is easy.

We are so confident of this finish process that we provide a limited lifetime warranty on ForeverShine™ products installed in residential applications.

Finish	Metal	Plastic
Alpine White (11)		■
Polished Chrome (21)	■	■
Gold (45)	■	■
Bone (AA)		■
White (DY)		■
Biscuit (FF)		■
Antique Brass (97)	■	
Old Silver Pewter (98)	■	
Satin Brass (CH)	■	
Black (EK)	■	
Satin Chrome (FT)	■	
ForeverShine™ PVD Brass (GG)	■	
ForeverShine™ PVD Pearl Nickel (HD)	■	
ForeverShine™ PVD Satin Sheen (HI)	■	
ForeverShine™ PVD Platinum (HJ)	■	
Hard Coat Oil Rubbed Bronze (HM)	■	
ForeverShine™ PVD Polished Nickel (IB)	■	
ForeverShine™ PVD Brushed Nickel (ID)	■	

Material Selection

Tubular Plastic

Plastic (polypropylene) is used chiefly for molded parts, electrical insulation, packaging.

Tubular Brass

Brass is a yellowish alloy of copper and zinc used for enhancing items such as the Geberit BWO.

ABS

ABS (Acrylonitrile, Butadiene, Styrene) is a plastic that's hard and durable through a broad range of temperatures.

PVC

PVC, polyvinyl chloride, a widely used thermoplastic polymer, is tough, dent-resistant; and maintains properties over long periods of time.

Selecting a Remote

The Geberit Remote BWO Cable Drain features the same quality and performance as our full line of bath waste and overflow products, but with remote access possibilities. Its unique two-headed design gives you the flexibility of handle placement for ADA applications.

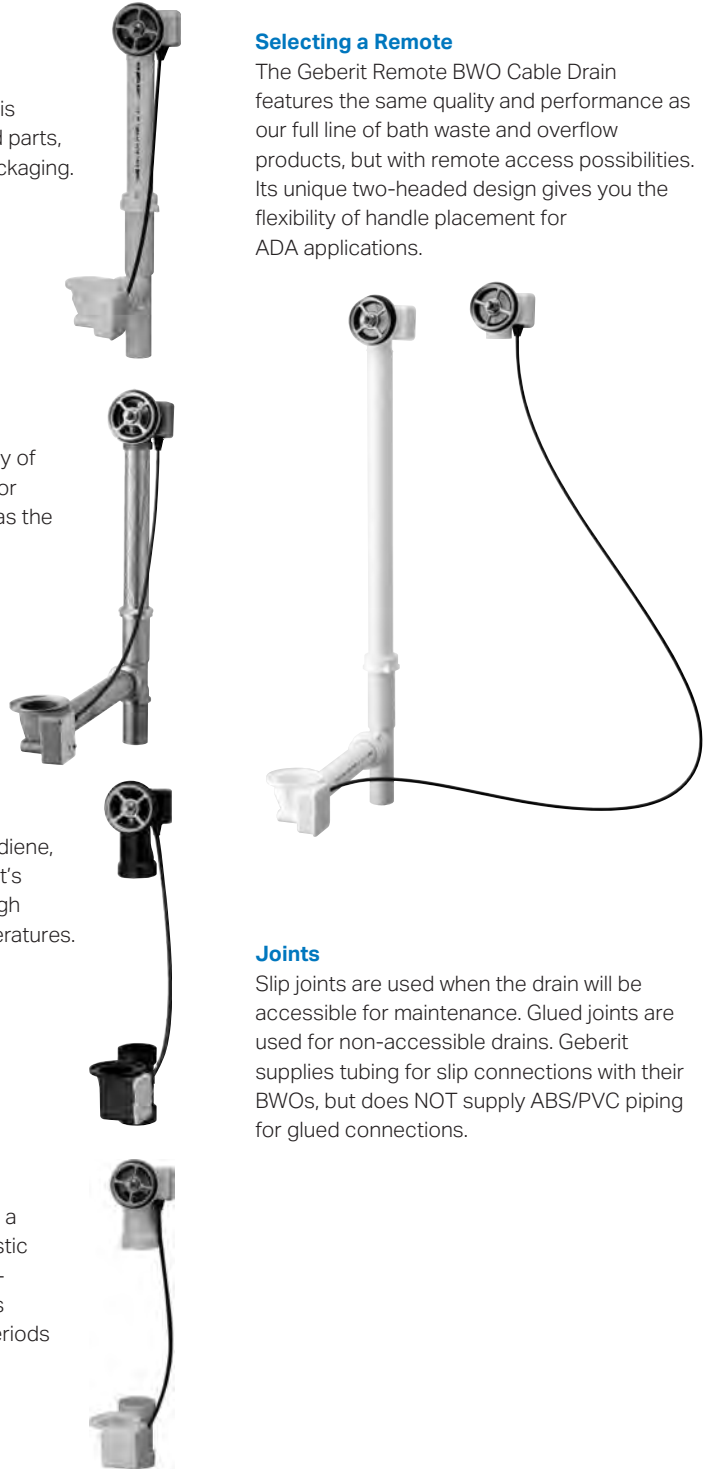

Joints

Slip joints are used when the drain will be accessible for maintenance. Glued joints are used for non-accessible drains. Geberit supplies tubing for slip connections with their BWOs, but does NOT supply ABS/PVC piping for glued connections.

Selecting the Right Size Bath Waste & Overflow

For convenience, use this page when sizing your cable length.

Sizing a Geberit cable drain is simple and easy. Start with acquiring the **Tub Depth** (see **Figure 1**), which serves as a rough guide for your final selection. While the actual definition of "tub depth" varies by manufacturer and model, the measurement is used to get a rough idea of the cable length you will need. Use the **Standard Rough-In Unit Cable Lengths** chart (below, right) to determine that cable length based on your tub depth.

To assure your rough calculations are correct and your BWO will function properly, however, please follow these steps (refer to **Figure 1**).

1. Determine the **Overflow Depth (A)** which is the distance from the overflow center to drain mounting surface.
2. Determine the **Drain Shoe Length (B)** which is the distance from the drain centerline to the overflow mounting surface.
3. Choose **material** and joint **connection type**. Because material selection and joint preparations selection are covered by local codes, be sure a professional contractor is involved. Geberit offers the complete spectrum of BWO materials to assure Code Compliance (see page 23). The materials offered are Tubular Polypropylene, Tubular Brass, ABS and PVC.
4. To determine the **final size** of your BWO for **Tubular Slip-Joint** Plastic/Brass cable drain, use **Figure 2** on page 25. To determine the final size of your BWO for **glued** ABS/PVC cable drain, use **Figure 3** on page 25.
5. Your information can now be used to find the **part number** on each type of Geberit BWO.

Once you have determined the size and part number, you can also give this information to your sales outlet so they can verify you have the right Geberit model for your needs.

Figure 1

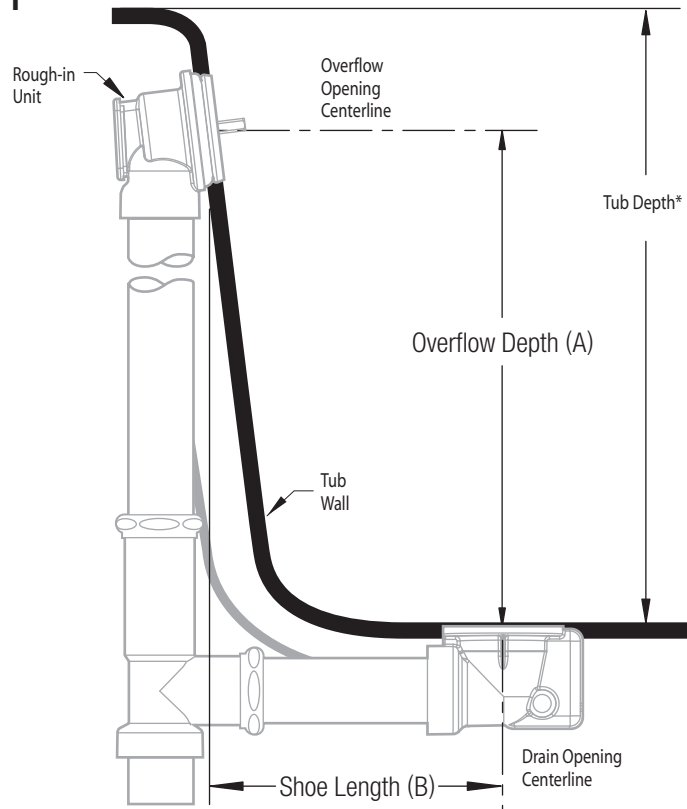

Standard Rough-In Unit Cable Lengths

Key	Typical Tub Depth*	Cable Length
■	12"-16" (301-402)	17" (432)
■	17"-24" (427-602)	27" (678)
■	17"-24" (427-602)	33" (828)
■	25"-29" (628-728)	43" (1,079)
■	30" (753)	59" (1,481)

* Varies by manufacturer and model number

Non-standard sizes, please refer to www.geberit.us

Geberit makes it easy to select the right drain with the online Bath Drain Selector, → geberit.us.com/drain_selection.php. Simply select a particular manufacturer and model number, bathtub size and the rough-in material.

Figure 2
Standard Tubular Slip Joint
Rough-In Unit Cable Length
Configuration Guide

Use this chart to figure cable needed for Plastic/Brass standard Tubular installations.

Example:

- Ⓐ Overflow Depth = 14"
 - Ⓑ Drain Shoe Length = 7.5"
- Requires a Rough-In Unit with a cable length of 27".

Custom installations can be achieved using standard Tubular Rough-In Units provided cable length is within acceptable range illustrated by shaded areas in guide.

Geberit recommends you review any custom installations with your sales outlet to assure you have the right model for your needs.

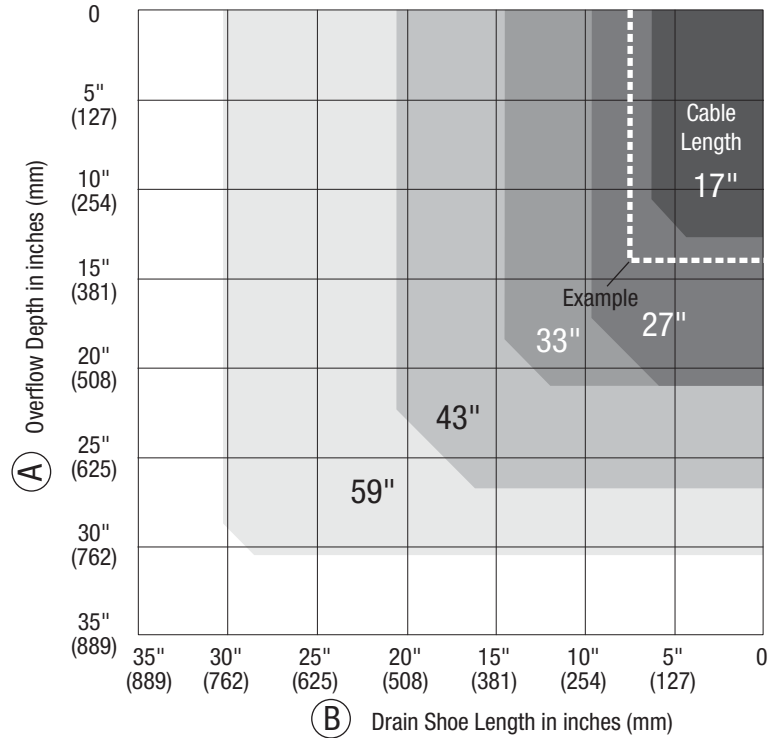
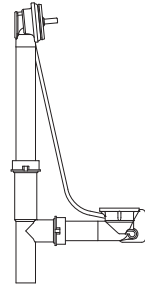

Figure 3
ABS/PVC Glued
Rough-In Unit Cable Length
Configuration Guide*

Use this chart to figure cable length needed for ABS/PVC glued custom installations.

Shaded areas indicate acceptable range of measurements for each cable length.

Example:

- Ⓐ Overflow Depth = 22.5"
 - Ⓑ Drain Shoe Length = 12.5"
- Requires a Rough-In Unit with a cable length of 43".

Geberit recommends you review any custom installations with your sales outlet to assure you have the right model for your needs.

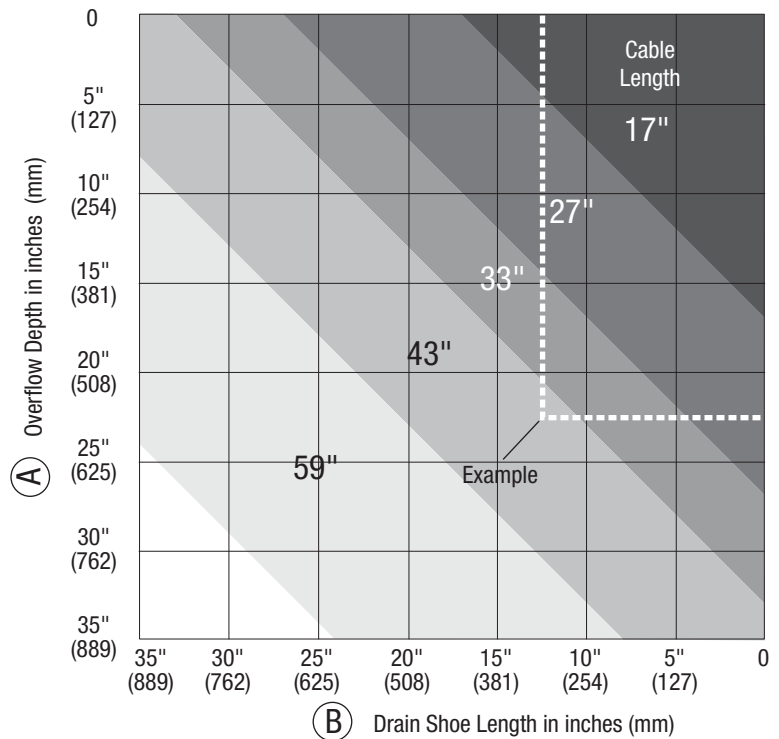
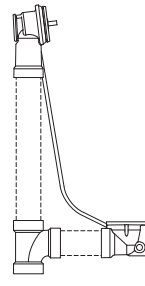

* ABS/PVC pipes not supplied

TurnControl BWO Systems

TurnControl Rough-In Unit

Does not include Trim Kit (see page 28)
(Fits Tub Wall Thickness 1/16"–5/16") (Figs. A & B)

Description	Model No.	Tub Depth*	Cable Length	Overflow Depth	Drain Shoe Length	List Price
Tubular Plastic Rough-In (Fig. A)	151.501.00.1	12"–16"	17"	Use Figure 2 on page 25		\$67.00
1½" Tubular plastic slip joint with PVC Tee connection	151.504.00.1	17"–24"	27"			72.00
	151.508.00.1	17"–24"	33"			79.00
	151.512.00.1	25"–29"	43"			94.00
	151.515.00.1	30"	59"			105.00
Tubular Brass Rough-In (Fig. A)	151.450.00.1	17"–24"	27"		344.00	
1½" Tubular Brass slip joint with Brass Tee connection				Use Figure 3 on page 25		
Tubular Brass Rough-In (Fig. A)	151.460.00.1	17"–24"	27"			344.00
Brass Chicago Code Tee						
ABS Rough-In (Fig. B)	151.502.00.1	12"–16"	17"			67.00
1½" ABS Sch 40 for glued joint (Pipes not supplied)	151.505.00.1	17"–24"	27"			72.00
	151.510.00.1	17"–24"	33"			79.00
	151.513.00.1	25"–29"	43"			94.00
	151.516.00.1	30"	59"			105.00
PVC Rough-In (Fig. B)	151.503.00.1	12"–16"	17"			67.00
1½" PVC Sch 40 for glued joint. (Pipes not supplied)	151.506.00.1	17"–24"	27"			72.00
	151.511.00.1	17"–24"	33"			79.00
	151.514.00.1	25"–29"	43"			94.00
	151.517.00.1	30"	59"			105.00

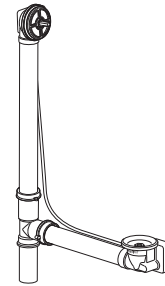

Fig. A
Tubular
Rough-In Unit

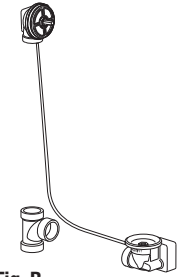

Fig. B
ABS/PVC
Rough-In Unit

TurnControl Remote Control Rough-In Unit

Does not include Trim Kit (see page 28) (Figs. C & D)

Description	Model No.	Tub Depth*	Cable Length	Overflow Depth	Drain Shoe Length	List Price
Tubular Plastic Rough-In (Fig. C)	151.518.00.1	17"–24"	59"	—	—	\$165.00
ABS Rough-In (Fig. D)	151.519.00.1	17"–24"	59"	—	—	165.00
PVC Rough-In (Fig. D)	151.520.00.1	17"–24"	59"	—	—	165.00

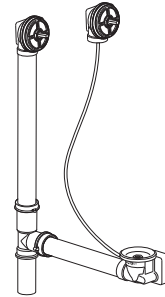

Fig. C
Tubular Remote Control
Rough-In Unit

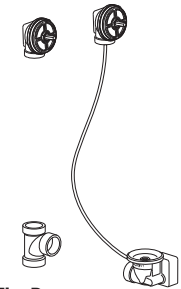

Fig. D
ABS/PVC Remote Control
Rough-In Unit

TurnControl Rough-In Unit (Non-Standard)

Does not include Trim Kit (see page 28) (Fits Tub Wall Thickness 1/16"–5/16") (Fig. A)

Description	Model No.	Tub Depth*	Cable Length	Overflow Depth	Drain Shoe Length	List Price
Tubular Plastic Rough-In (Fig. A) (Non-Standard)	150.183.00.1	17"–24"	33"	30.50"	20.50"	\$104.00
	150.184.00.1	25"–29"	43"	30.50"	30.00"	116.00



Fully detailed information can be found at → geberit.us

* Tub Depth is only a rough calculation. To ensure proper cable length, refer to information on pages 24 and 25.

TurnControl Complete Unit

Includes Trim Kit and Tubular Plastic Rough-In Unit (Fits Tub Wall Thickness 1/16"–5/16") (Figs. E & F)



Material	Finish	Tub Depth*	Cable Length	Overflow Depth	Drain Shoe Length	Traditional Model No. (Fig. E)	List Each	Euro Model No. (Fig. F)	List Each
Metal	ForeverShine™ PVD Brushed Nickel	17"–24"	27"	Use Figure 2 on page 25		150.176.ID.1	\$222.00	—	—
	Polished Chrome	17"–24"	27"			—	—	151.521.21.1	\$111.00
	Hard Coat Oil Rubbed Bronze	17"–24"	27"			—	—	151.521.HM.1	141.00
	ForeverShine™ PVD Polished Nickel	17"–24"	27"			—	—	151.521.IB.1	138.00
	ForeverShine™ PVD Brushed Nickel	17"–24"	27"			—	—	151.521.ID.1	138.00
Plastic	Polished Chrome	17"–24"	27"			150.156.21.1	130.00	151.531.21.1	86.00
	White	17"–24"	27"			150.156.DY.1	135.00		
	Biscuit	17"–24"	27"			150.156.FF.1	135.00		

Includes Trim Kit and ABS Pipe Rough-In Unit (Fits Tub Wall Thickness 1/16"–5/16") (Fig. G)



Metal	Polished Chrome	17"–24"	27"	Use Figure 2 on page 25		—	—	151.522.21.1	\$111.00
	Hard Coat Oil Rubbed Bronze	17"–24"	27"			—	—	151.522.HM.1	141.00
	ForeverShine™ PVD Polished Nickel	17"–24"	27"			—	—	151.522.IB.1	138.00
	ForeverShine™ PVD Brushed Nickel	17"–24"	27"			—	—	151.522.ID.1	138.00

Includes Trim Kit and PVC Pipe Rough-In Unit (Fits Tub Wall Thickness 1/16"–5/16") (Fig. G)



Metal	Polished Chrome	17"–24"	27"	Use Figure 2 on page 25		—	—	151.523.21.1	111.00
	Hard Coat Oil Rubbed Bronze	17"–24"	27"			—	—	151.523.HM.1	141.00
	ForeverShine™ PVD Polished Nickel	17"–24"	27"			—	—	151.523.IB.1	138.00
	ForeverShine™ PVD Brushed Nickel	17"–24"	27"			—	—	151.523.ID.1	138.00

Note: ForeverShine™ finishes ensure the quality and look of your Geberit BWO will last a lifetime. Geberit offers a limited lifetime warranty on ForeverShine™ products installed in residential applications.

* Tub Depth is only a rough calculation. To ensure proper cable length, refer to information on pages 24 and 25.

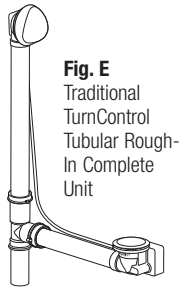

Fig. E
Traditional
TurnControl
Tubular Rough-
In Complete
Unit

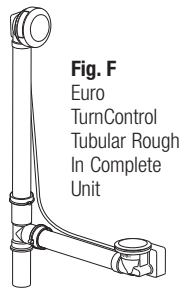

Fig. F
Euro
TurnControl
Tubular Rough-
In Complete
Unit

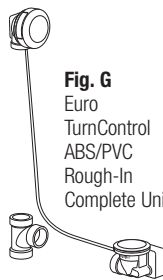

Fig. G
Euro
TurnControl
ABS/PVC
Rough-In
Complete Unit

TurnControl BWO Systems (continued)

TurnControl Trim Kit – Includes Handle and Plunger

Material	Finish	Model No.		List Price	
		Traditional	Euro	Traditional	Euro
Metal	Polished Chrome	151.551.21.1	151.553.21.1	\$94.00	\$63.00
	Hard Coat Oil Rubbed Bronze	151.551.HM.1	151.553.HM.1	148.00	94.00
	ForeverShine™ PVD Polished Nickel	151.551.IB.1	151.553.IB.1	143.00	90.00
	ForeverShine™ PVD Brushed Nickel	151.551.ID.1	151.553.ID.1	143.00	90.00
	Gold	151.551.45.1		175.00	
	Antique Brass	151.551.97.1		134.00	
	Old Silver Pewter	151.551.98.1		134.00	
	Satin Brass	151.551.CH.1		134.00	
	Black	151.551.EK.1		148.00	
	Satin Chrome	151.551.FT.1		134.00	
	ForeverShine™ PVD Brass	151.551.GG.1		134.00	
	ForeverShine™ PVD Pearl Nickel	151.551.HD.1		153.00	
	ForeverShine™ PVD Satin Sheen	151.551.HI.1		134.00	
	ForeverShine™ PVD Platinum	151.551.HJ.1		153.00	
Plastic	Alpine White	151.550.11.1		56.00	
	Gold	151.550.45.1		121.00	
	Polished Chrome	151.550.21.1	151.552.21.1	56.00	38.00
	Bone	151.550.AA.1		62.00	
	White	151.550.DY.1		62.00	
	Biscuit	151.550.FF.1		62.00	
	ForeverShine™ PVD Brass	151.550.GG.1		121.00	

Traditional Plastic Handle

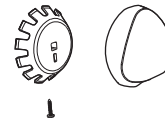

Traditional Metal Handle



Euro Plastic Handle

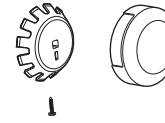

Euro Metal Handle



Plunger

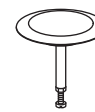

TurnControl, Remote Control Trim Kit

Order Two Trim Kits in desired finish.

TurnControl Accessories

Description	Model No.	List Price
ADA Handle Extension, Polished Chrome For Metal Handles Only	241.789.21.1	\$26.00
Test Plug Kit	240.691.00.1	27.00
Extended Tub Wall Thickness Kit 3/8"–1/2", Tubular Plastic/Brass Rough-In	241.769.00.1	41.00
Extended Tub Wall Thickness Kit 3/8"–1/2", ABS/PVC Rough-In	241.771.00.1	41.00
Extended Tub Wall Thickness Kit 3/8"–1/2", Tub Filler	241.772.00.1	41.00
Extended Tub Wall Thickness Kit 9/16"–3/4", Tubular/Brass Rough-In	241.773.00.1	41.00
Extended Tub Wall Thickness Kit 9/16"–3/4", ABS/PVC Rough-In	241.774.00.1	41.00
Extended Tub Wall Thickness Kit 9/16"–3/4", Tub Filler	241.775.00.1	41.00



ADA Handle Extension

Test Plug Kit



Extended Tub Wall Thickness Kit

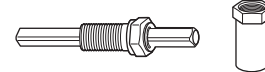

PushControl BWO Systems

PushControl Complete Unit

Includes Trim Kit, Tubular Plastic Rough-In Unit and Installation Tools
(Fits Tub Wall Thickness 1/16"–1/2")



Material	Finish	Model No.	Tub Depth*	Cable Length	Overflow Depth	Drain Shoe Length	List Price
Metal	Polished Chrome	151.603.21.1	17"–24"	27"	Use Figure 2 on page 25		\$218.00
		151.605.21.1	17"–24"	33"			235.00
	ForeverShine™ PVD Brushed Nickel	151.603.ID.1	17"–24"	27"			274.00
		151.605.ID.1	17"–24"	33"			289.00
Plastic	Polished Chrome	151.602.21.1	17"–24"	27"	165.00		
		151.604.21.1	17"–24"	33"	180.00		

* Tub Depth is only a rough calculation. To ensure proper cable length, refer to information on pages 24 and 25.

PushControl Accessories

Description	Model No.	List Price
PushControl Toolkit (Included with purchase of each PushControl Complete Unit)	241.729.00.1	\$32.00

Note: ForeverShine™ finishes ensure the quality and look of your Geberit BWO will last a lifetime. Geberit offers a limited lifetime warranty on ForeverShine™ products installed in residential applications.

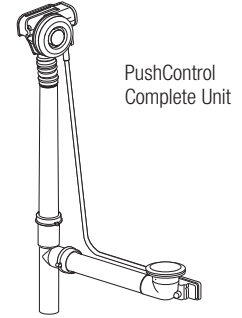

PushControl Complete Unit

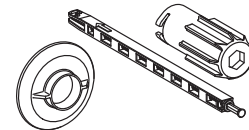

PushControl Toolkit

TurnControl BWO with Cascading Tub Filler Systems

Cascading Tub Filler, Traditional TurnControl Complete Unit –

Includes Trim Kit, Tubular Brass Rough-In Unit and Vacuum Breaker



Material	Finish	Model No.	Tub Depth*	Cable Length	Overflow Depth	Drain Shoe Length	Tub Wall Thickness	List Price
Metal	Polished Chrome	151.466.21.1	17"–24"	27"	Use Figure 2 on page 25		1/16"–5/16"	\$872.00
		151.467.21.1	17"–24"	27"			3/8"–1/2"	872.00
		151.468.21.1	17"–24"	27"			9/16"–3/4"	872.00
ForeverShine™ PVD Brass		151.466.GG.1	17"–24"	27"	1/16"–5/16"	956.00		
		151.467.GG.1	17"–24"	27"	3/8"–1/2"	956.00		
		151.468.GG.1	17"–24"	27"	9/16"–3/4"	956.00		
ForeverShine™ PVD Brushed Nickel		151.466.ID.1	17"–24"	27"	1/16"–5/16"	956.00		
		151.467.ID.1	17"–24"	27"	3/8"–1/2"	956.00		
		151.468.ID.1	17"–24"	27"	9/16"–3/4"	956.00		

* Tub Depth is only a rough calculation. To ensure proper cable length, refer to information on pages 24 and 25.

Cascading Tub Filler, TurnControl ADA Handle Extension –

For Metal Handles Only

Description	Model No.	List Price
ADA Handle Extension, Polished Chrome	241.789.21.1	\$26.00

Note: ForeverShine™ finishes ensure the quality and look of your Geberit BWO will last a lifetime. Geberit offers a limited lifetime warranty on ForeverShine™ products installed in residential applications.

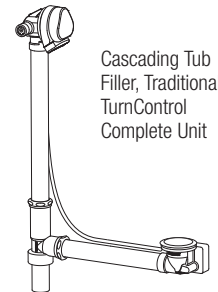

Cascading Tub Filler, Traditional TurnControl Complete Unit



ADA Handle Extension

Limited Warranty

LIMITED WARRANTY – The Company offers limited warranties regarding certain of its products. Such limited warranties can be found in the Company's catalogs and on its website at → [geberit.us](https://www.geberit.us). **THE COMPANY SHALL NOT BE LIABLE TO BUYER, OR TO ANYONE CLAIMING UNDER BUYER, FOR ANY OTHER OBLIGATIONS OR LIABILITIES, INCLUDING, BUT NOT LIMITED TO, OBLIGATIONS OR LIABILITIES ARISING OUT OF BREACH OF CONTRACT OR WARRANTY, NEGLIGENCE OR OTHER TORT OR ANY THEORY OF STRICT LIABILITY, WITH RESPECT TO THE PRODUCTS OR THE COMPANY'S ACTS OR OMISSIONS OR OTHERWISE. THE COMPANY AND BUYER AGREE THAT THE EXPRESS WARRANTIES DESCRIBED ABOVE ARE EXCLUSIVE AND IN LIEU OF ALL OTHER WARRANTIES. ALL OTHER EXPRESS WARRANTIES ARE DISCLAIMED. FOR COMMERCIAL PRODUCTS, ALL WARRANTIES IMPLIED BY LAW, INCLUDING WITHOUT LIMITATION THE IMPLIED WARRANTIES OF MERCHANTABILITY AND FITNESS FOR A PARTICULAR PURPOSE, ARE DISCLAIMED. FOR CONSUMER PRODUCTS, WARRANTIES IMPLIED BY LAW, INCLUDING THOSE OF MERCHANTABILITY AND FITNESS FOR A PARTICULAR PURPOSE, ARE EXPRESSLY LIMITED TO THE PERIOD OF THE EXPRESS LIMITED WARRANTY FOR THE RELEVANT PRODUCT.** Some States do not allow limitations on how long an implied warranty lasts, so the above limitation may not apply to Buyer. **IN NO EVENT SHALL THE COMPANY BE LIABLE FOR INCIDENTAL, CONSEQUENTIAL, INDIRECT OR SPECIAL DAMAGES. THE COMPANY'S AGGREGATE LIABILITY WITH RESPECT TO A DEFECTIVE PRODUCT AND THIS CONTRACT SHALL BE LIMITED TO AN AMOUNT EQUAL TO THE MONIES PAID TO THE COMPANY FOR THAT DEFECTIVE PRODUCT.** Some states do not allow the exclusion or limitation of incidental or consequential damages, so the above limitation or exclusion may not apply to Buyer. Please see the Company's limited warranty statement for details on limitations.

TO WHOM DOES THIS WARRANTY APPLY? – The Company extends the following limited warranty to the original user only.

WHAT DOES THIS WARRANTY COVER AND HOW LONG DOES IT LAST? This warranty covers the following Commercial Products:

BATH WASTE & OVERFLOW PRODUCTS WARRANTY – Bath Waste & Overflow products are warranted against defects in material and workmanship for the life of the Products.

GEBERIT INSTALLATION SYSTEMS – Frame, Flushing Tanks, and Actuators for Geberit Installation Systems are warranted against defects in material and workmanship for the life of the Products. Filling and Flushing valves are warranted against defects in material and workmanship for 10 years from the date of Product purchase. The Company offers NO WARRANTY for Product batteries.

FIVE YEAR FINISH WARRANTY – RESIDENTIAL – For Products used in residential applications, the finish of the Product is warranted against material manufacturing defects for a period of five (5) years from the date of Product purchase.

FOREVERSHINE™ and HARD COAT FINISHES WARRANTY – RESIDENTIAL – ForeverShine™ and Hard Coat finishes installed in residential-use applications are warranted not to corrode, tarnish or discolor for the life of the Product.

OTHER WARRANTIES – All other Products not covered above are warranted against material manufacturing defects for a period of one (1) year from the date of Product purchase.

WHAT THIS WARRANTY DOES NOT COVER – The Company will not be liable for any labor, transportation or consequential expenses not specifically stated above. There is **NO WARRANTY** in cases of damage in transit, negligence, abuse, abnormal usage, misuse, accidents, normal wear and tear, damage due to environmental or natural

elements, failure to follow the Company's instructions, unauthorized repair, incorrectly performed maintenance or repair, improper installation or storage or use of acidic, abrasive cleaning materials. In order for this Warranty to apply, Buyer must retain and provide to the Company receipts showing date of Product purchase and documenting proper maintenance. Any oral or written description of the Products is for the sole purpose of identifying the Products and shall not be construed as an express warranty. **THE COMPANY SHALL NOT BE LIABLE TO BUYER, OR TO ANYONE CLAIMING UNDER BUYER, FOR ANY OTHER OBLIGATIONS OR LIABILITIES, INCLUDING, BUT NOT LIMITED TO, OBLIGATIONS OR LIABILITIES ARISING OUT OF BREACH OF CONTRACT OR WARRANTY, NEGLIGENCE OR OTHER TORT OR ANY THEORY OF STRICT LIABILITY, WITH RESPECT TO THE PRODUCTS OR THE COMPANY'S ACTS OR OMISSIONS OR OTHERWISE. THE COMPANY AND BUYER AGREE THAT THE EXPRESS WARRANTIES DESCRIBED ABOVE ARE EXCLUSIVE AND IN LIEU OF ALL OTHER WARRANTIES. ALL OTHER EXPRESS WARRANTIES ARE DISCLAIMED. FOR COMMERCIAL PRODUCTS, ALL WARRANTIES IMPLIED BY LAW, INCLUDING WITHOUT LIMITATION THE IMPLIED WARRANTIES OF MERCHANTABILITY AND FITNESS FOR A PARTICULAR PURPOSE, ARE DISCLAIMED. FOR CONSUMER PRODUCTS, WARRANTIES IMPLIED BY LAW, INCLUDING THOSE OF MERCHANTABILITY AND FITNESS FOR A PARTICULAR PURPOSE, ARE EXPRESSLY LIMITED TO THE PERIOD OF THE EXPRESS LIMITED WARRANTY STATED ABOVE FOR THE RELEVANT PRODUCT.** Some States do not allow limitations on how long an implied warranty lasts, so the above limitation may not apply to you. Any assistance the Company provides to or procures for Buyer outside the terms, limitations or exclusions of this warranty will not constitute a waiver of the terms, limitations or exclusions of this limited warranty, nor will such assistance extend or revive the warranty. The Company will not reimburse Buyer for any expenses incurred by Buyer in repairing, correcting or replacing any defective Products, except for expenses incurred with the Company's prior written permission.

HOW TO GET SERVICE – For complete warranty details, or to provide notice of a warranty claim or request warranty service, contact your Geberit Sales Representative or Geberit, Customer Service, 2100 S. Clearwater Drive, Des Plaines, Illinois 60018 or 847-803-5000. As the Company's sole and exclusive obligation under this warranty (and Buyer's sole and exclusive remedy), upon prompt written notice of breach from Buyer during the warranty period, the Company will either replace or repair the defective Product or refund the wholesale purchase price, at its option, if an inspection by the Company discloses defects in material or workmanship covered by this warranty. These warranty provisions do not cover the battery shipped with the electronic products.

LIMITATION ON DAMAGES – IN NO EVENT SHALL THE COMPANY BE LIABLE FOR INCIDENTAL, CONSEQUENTIAL, INDIRECT OR SPECIAL DAMAGES. WITHOUT LIMITING THE FOREGOING, THE COMPANY SHALL NOT BE LIABLE FOR ANY DAMAGE A PALM DEVICE OR ANY SOFTWARE OR RELATED EQUIPMENT ALLEGEDLY CAUSES TO A SYSTEM OR OTHERWISE. THE COMPANY'S AGGREGATE LIABILITY WITH RESPECT TO A DEFECTIVE PRODUCT AND THIS CONTRACT SHALL BE LIMITED TO AN AMOUNT EQUAL TO THE MONIES PAID TO THE COMPANY FOR THAT DEFECTIVE PRODUCT.

Some states do not allow the exclusion or limitation of incidental or consequential damages, so the above limitation or exclusion may not apply to you.

HOW DOES STATE LAW APPLY? – This warranty gives you specific legal rights, and you may also have other rights which vary from state to state.

Restrictions Apply

Geberit
2100 S. Clearwater Drive
Des Plaines, IL 60018
USA

P 800-566-2100
F 847-803-5454

→ geberit.us

