

CG365C/S



## FEATURES

Maintain control with dual-stacked burners that go from 20,000 Btu down to a mere breath of flame

Simmer and melt sauces, soups, and marinades easily with the lower tier of the dual-stacked burner

Slip this stunning minimalist design flush with your countertop with illuminated, front-facing control knobs

Reignites flame automatically with spark ignition system

Cleanup is a snap as sealed, seamless burner pans contain splashes and spills

Move pots and pans effortlessly across the continuous cast-iron grates

Comes standard with black control knobs

## ACCESSORIES

High altitude conversion kits available

Signature red, black or brushed stainless control knobs

Accessories available through an authorized dealer.

For local dealer information, visit [subzero-wolf.com/locator](http://subzero-wolf.com/locator).



## KNOB OPTIONS



## COOKTOP SPECIFICATIONS

- 2 - 9,200 Btu Burner
- 2 - 12,000 Btu Burner
- 1 - 20,000 Btu Burner

**PRODUCT SPECIFICATIONS**

Model	CG365C/S
Dimensions	36"W x 6 3/4"H x 21"D
Electrical Supply	120 VAC, 60 Hz
Electrical Service	15 amp dedicated circuit
Gas Supply	3/4" ID line
Gas Inlet	1/2" NPT female

**ELECTRICAL**

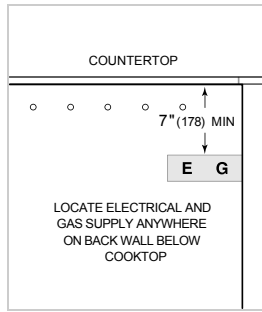

**GAS**

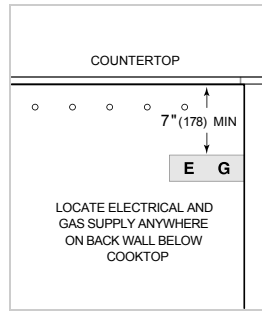

**NOTE:** Dimensions in parenthesis are in millimeters unless otherwise specified

**DIMENSIONS**

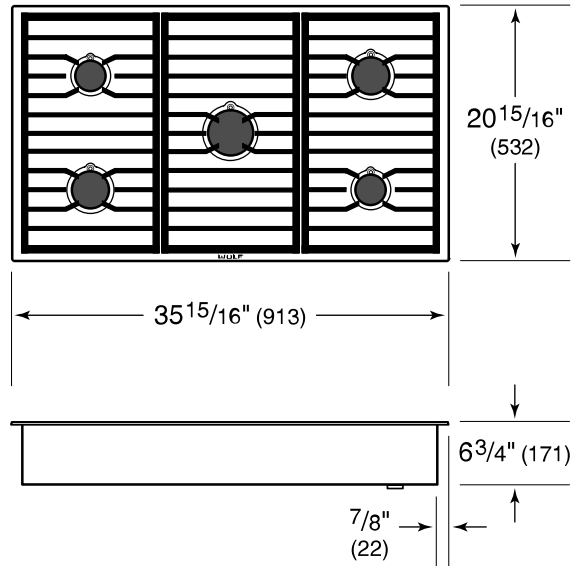

**FLUSH INSTALLATION**

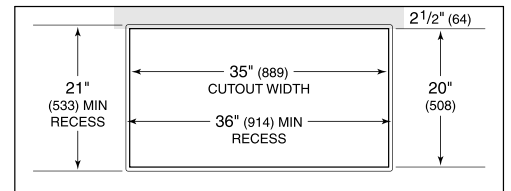
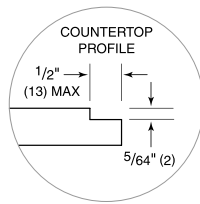

COUNTERTOP CUTOUT

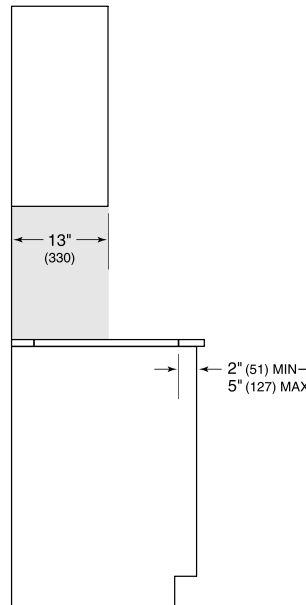

SIDE VIEW

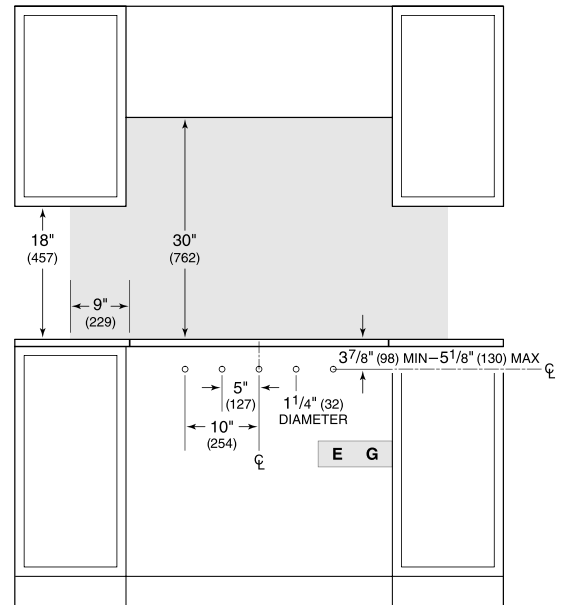

FRONT VIEW

**NOTE:** Shaded area above countertop indicates minimum clearance to combustible surfaces, combustible materials cannot be located within this area. Maximum facade thickness 1" (25). 1" (25) thickness extends 17" (432) left and right and 2" (51) above and below centerlines. Outside corner radius 3/8" (10).