

CG243TF/S



## FEATURES

Maintain control with dual-stacked burners that go from 12,000 Btu down to a mere breath of flame

Simmer and melt sauces, soups, and marinades easily with the lower tier of the dual-stacked burner

Pairs easily with other transitional framed cooktops

Reignites flame automatically with spark ignition system

Cleanup is a snap as sealed, seamless burner pans contain splashes and spills

Select stylish stainless control knobs capped in black

Move pots and pans easily across continuous cast-iron grates

## ACCESSORIES

Filler Strip

Filler Strip for Downdraft

Single Burner Wok Grate

Accessories available through an authorized dealer.  
For local dealer information, visit [subzero-wolf.com/locator](http://subzero-wolf.com/locator).

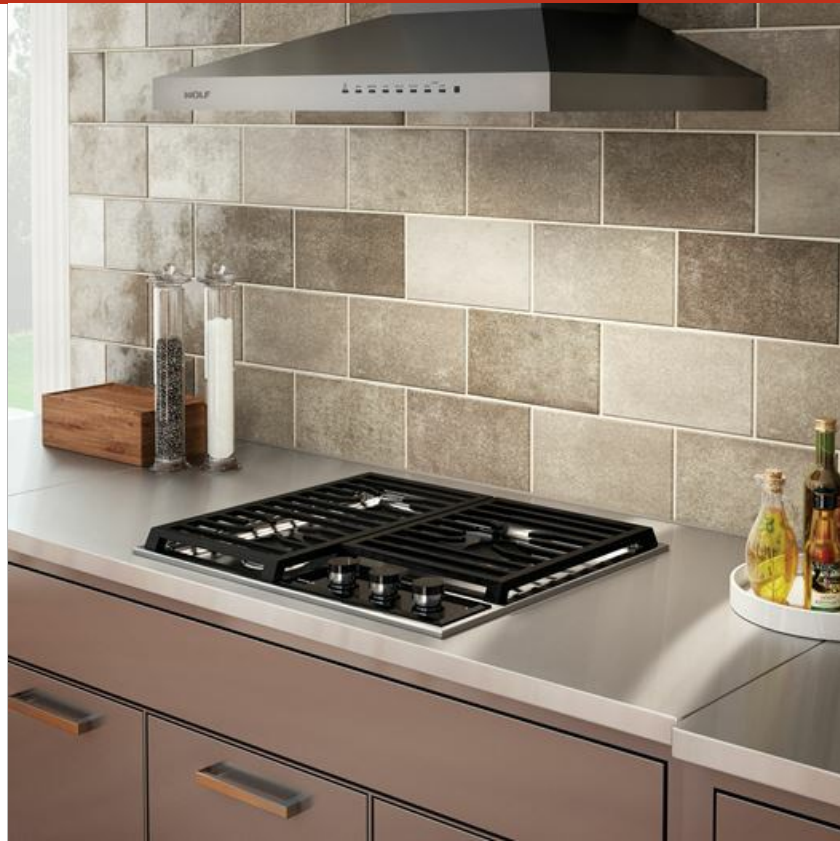

## COOKTOP SPECIFICATIONS

- 1 - 9,200 Btu Burner
- 1 - 12,000 Btu Burner
- 1 - 18,000 Btu Burner

**PRODUCT SPECIFICATIONS**

Model	CG243TF/S
Dimensions	23 5/8"W x 4"H x 21"D
Electrical Supply	120 VAC, 60 Hz
Electrical Service	15 amp dedicated circuit
Gas Supply	3/4" ID line
Gas Inlet	1/2" NPT female

**ELECTRICAL**

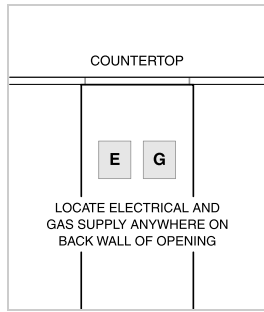

**GAS**

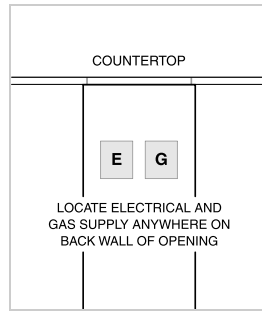

NOTE: Dimensions in parenthesis are in millimeters unless otherwise specified

**DIMENSIONS**

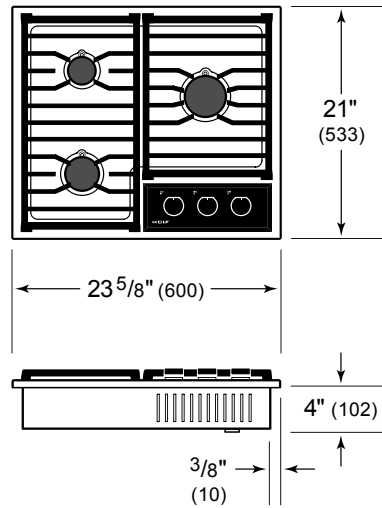

**STANDARD INSTALLATION**

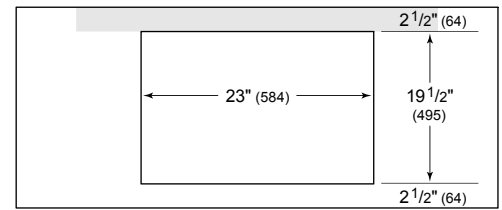

COUNTERTOP CUT-OUT

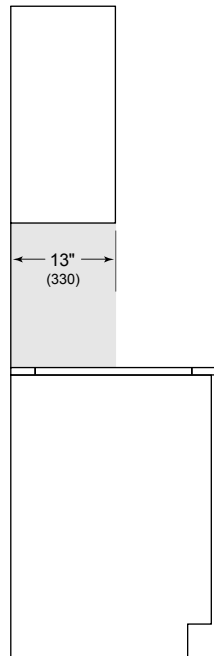

SIDE VIEW

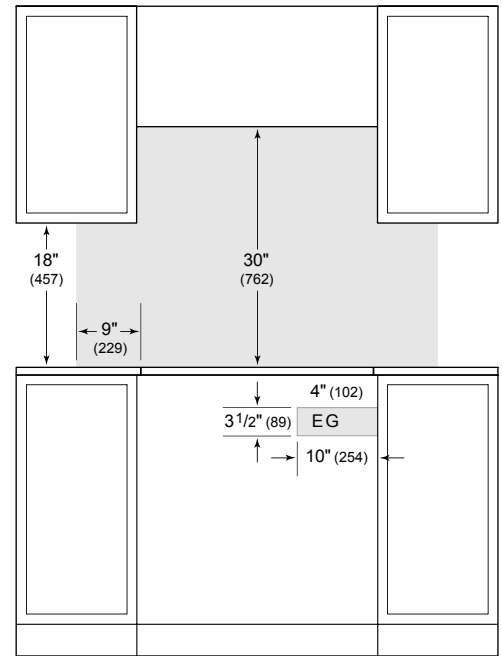

FRONT VIEW

NOTE: Shaded area above countertop indicates minimum clearance to combustible surfaces, combustible materials cannot be located within this area. Electrical and gas supply location only applies to installations with built-in oven.