



www.winemate.com

Wine Cooling System

WM-1500HZD, WM-2500HZD

WM-3500HZD, WM-4500HZD

WM-6500HZD, WM-8500HZD

Installation, Use & Care Manual



By *Vinotemp*



www.vinotemp.com

Read and save these instructions

Important Safety Information

NOTES:

- Do not plug in until 24 hours after delivery.
- Do not use a ground fault interrupter (GFI).
- A dedicated 20 AMP circuit for WM-1500~2500HZD and 30 AMP for WM-4500~8500HZD are required.

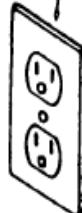
⚠ WARNING	
	
To avoid the risk of electrical shock, property damage, personal injury or death:	
<ul style="list-style-type: none">• The power cord must be plugged into a 3-prong grounding-type wall receptacle, grounded in accordance with the National Electrical Code, ANSI/NFPA 70 - latest edition and local codes and ordinances.• It is the personal responsibility of the consumer to have a proper 3-prong wall receptacle installed by a qualified electrician.• DO NOT, UNDER ANY CIRCUMSTANCES, REMOVE THE POWER CORD GROUNDING PRONG.• A separate adequately fused and grounded circuit should be available for this appliance.• Do not remove any grounding wires from individual components while servicing, unless the component is to be removed and replaced. <i>It is extremely important to replace all grounding wires when components are replaced.</i>	
 POWER SUPPLY CORD WITH 3-PRONG GROUNDING PLUG	 GROUNDING TYPE WALL RECEPTACLE

⚠ WARNING	
	ELECTRIC SHOCK HAZARD Disconnect electric supply from appliance before servicing. Replace all panels before operating. Failure to do so could result in death or electrical shock.

Table of Contents

Features & Specifications.....	3
Installation Instructions.....	6
Temperature & Humidity.....	14
Care Guide.....	18
Troubleshooting.....	19
Electrical Diagrams.....	22
Customer Support.....	24
Warranty.....	25

Features and Specifications

- HZD series cooling units are designed and used to provide a stable temperature between 50~65 °F for a properly insulated space.
- The refrigerated space will maintain humidity ranges within 50~70% RH.
- These temperature and humidity ranges are optimized for long term storage of wine.
- Temperature is controlled and humidity is adjusted using patented technology.
- Horizontal cold-air supply is optimized for use in the wide cabinets or wine rooms.
- The unit is self-contained ready for easy installation and use.

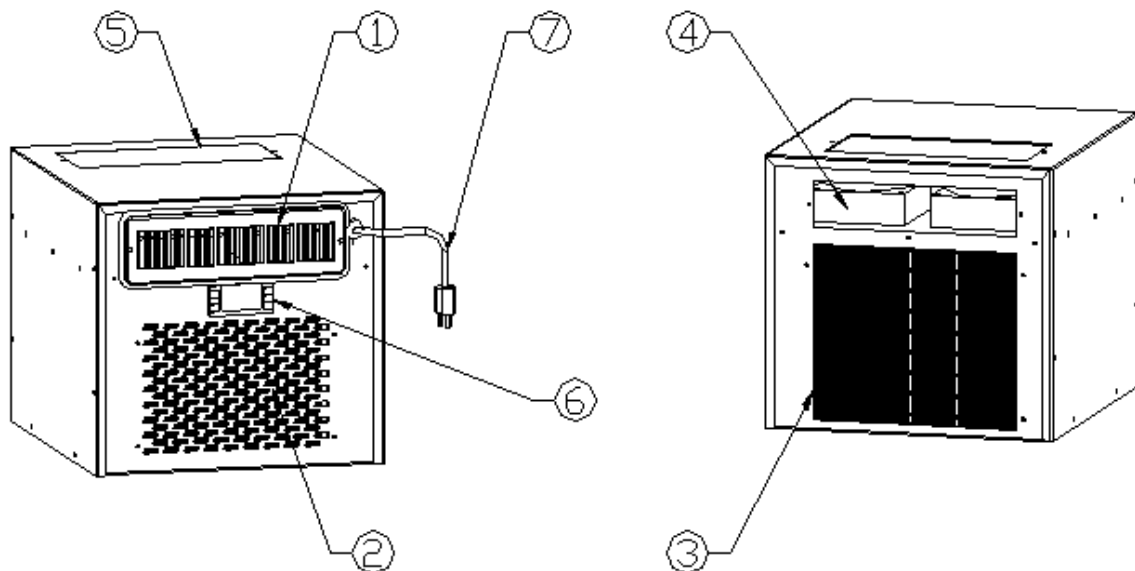

1. COLD-AIR SUPPLY
2. CELLAR-AIR RETURN
3. AMBIENT-AIR INTAKE
4. HOT-AIR REAR EXHAUST
5. HOT-AIR TOP EXHAUST (OPTION)
6. DIGITAL CONTROLLER
7. POWER CORD

Fig. 1.1 FEATURE DESCRIPTIONS

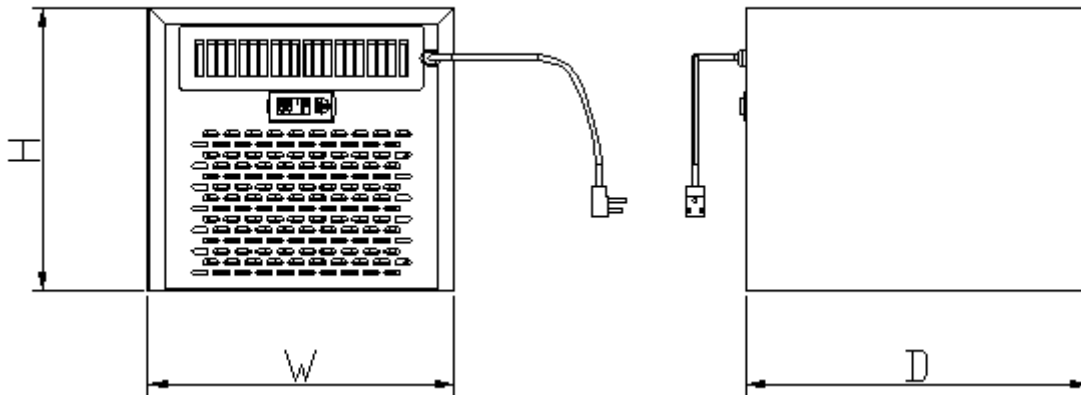

Fig. 1.2 DIMENSIONS



The specifications and dimensions are listed as follows:

Model	CFM	Cellar Size (cu ft)	Dimensions W"XD"XH"	Electrical	Weight (lb)
WM-1500HZD	120	90	14.25X16X13.25	115V/60HZ/4A	50
WM-2500HZD	180	200	14.25X16X13.25	115V/60HZ/5A	55
WM-3500HZD	250	650	14.25X21.25X19.75	115V/60Hz/6A	75
WM-4500HZD	250	1000	14.25X21.25X19.75	115V/60Hz/9A	75
WM-6500HZD	500	1500	17X28X22	115V/60Hz/14A	110
WM-8500HZD	500	2000	17X28X22	115V/60Hz/16A	110

NOTES:

- Also see the voltage, frequency and current specified on the label at the cooling unit.
- The rated capacity is determined under the cellar and ambient temperatures of 55°F and 75°F with R13 interior and R19 exterior insulations. Any lower cellar temperature, higher ambient temperature and less insulation will cause reducing capacity and may not maintain 55°F.
- The ambient temperatures for WM-1500HZD shall not be higher than 78°F or lower than 50°F in order to operate properly.
- The ambient temperatures for WM-2500HZD shall not be higher than 95°F or lower than 50°F in order to operate properly.
- The ambient temperatures for WM-4500~8500HZD shall not be higher than 95°F or lower than 50°F in order to operate properly.

Installation Instructions

 WARNING	
	<p>Always check wiring harness connections before initiating any test procedures.</p> <p>Disconnect electric power from the appliance before performing any maintenance or repairs.</p> <p>Voltage checks should be made by inserting meter probes beside the wires in the connector blocks with the electric power source on and the connector block plugged in.</p> <p>Resistance checks should be made on components with the electric power off and the connector block disconnected.</p>

NOTES:

- Mounting brackets, screws, gaskets and other seal materials are not included.
- Do not install any ducts onto the supply, return, intake and exhaust.
- Because of potential safety hazards under a certain condition we strongly recommend against the use of an extension cord. However, if you still select to use an extension cord, it is absolutely necessary that it is a UL LISTED 3-wire grounding type appliance extension cord having a 3-blade grounding plug and a 3-slot receptacle that will plug into the appliance. The marked rating of the extension cord shall be 115 V, 15 A or equivalent for WM-1500~2500HZD and 115 V, 20 A or equivalent for WM-3500~8500HZD and not greater than 15ft in length.

1. General Instructions

- The cooling unit produces cooling supplied into the cellar, meanwhile it also generates heat that must be exhausted outside the cellar. So the cold-air supply with return-air intake side and the hot-air exhaust with ambient-air intake side must be separated and sealed. Through-wall installations can separate these two sides.
- Furthermore, the condenser of cooling unit must intake adequate fresh ambient-air to work properly. The ambient-air intake and hot-air exhaust must not be short-circulated. Both of them must remain unobstructed 36" clearance all around. The area into which the hot air is exhausted must be well ventilated. If it is not, heat generated by the unit will build up and the unit will not operate properly.
- Additionally, cold-air supply from the front grille must remain unobstructed 36" clearance.
- The ambient temperatures shall not be above and below what are specified.

2. WM-1500~2500HZD cabinet installation

- Cut a rectangular inside opening with the 1/4" clearance inwards to the width and height of the cooling unit. By not going through, leave 1/2" lip inside at the wall to place the gaskets (see Fig 2.1).
- If top exhaust installation, cut another rectangular opening at the top of the cabinet to the length and width of the top exhaust.
- Install 2 pieces of 1/4" ID wood thread inserts at the ceiling (see Fig.2.1 & 2.2).
- Place the gaskets (1/2" foam tape) on the mounting lip sides (see Fig 2.3).
- If top exhaust installation, place another gaskets along the top exhaust at the top of the cooling unit (see Fig.2.4).
- Move the cooling unit towards the mounting sides and push to press the gaskets (see Fig 2.5).
- Use 2 brackets and 1/4" screws with 7/16" wrench to secure the cooling unit (see Fig 2.6).
- Install the cabinet grille on the cabinet exterior wall (see Fig. 2.7).
- Plug the cooling unit in the cabinet receptacle.
- Plug the wine cabinet.

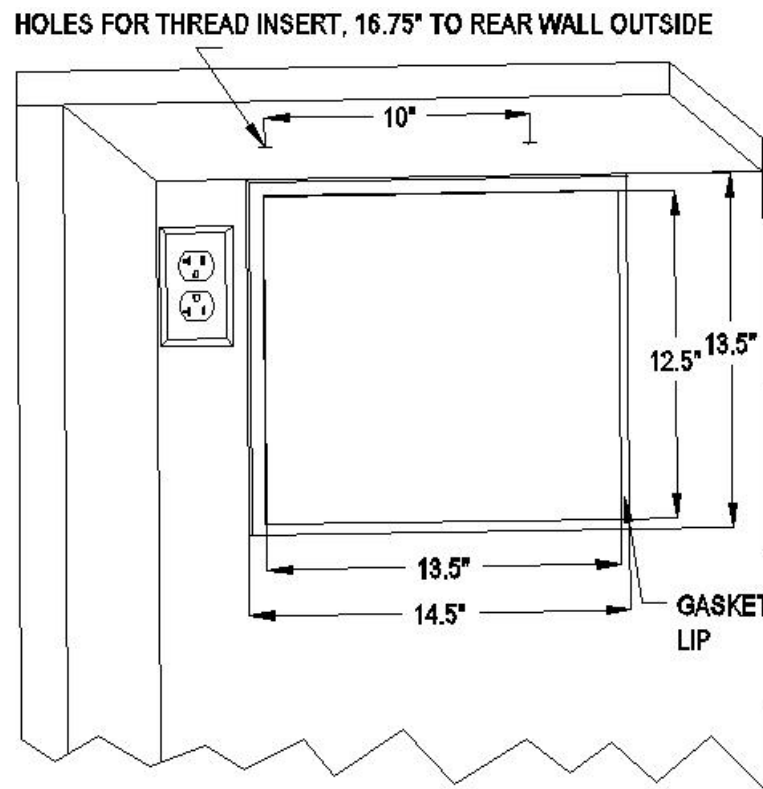

Fig. 2.1 CABINET CUTOUT & GASKET LIP

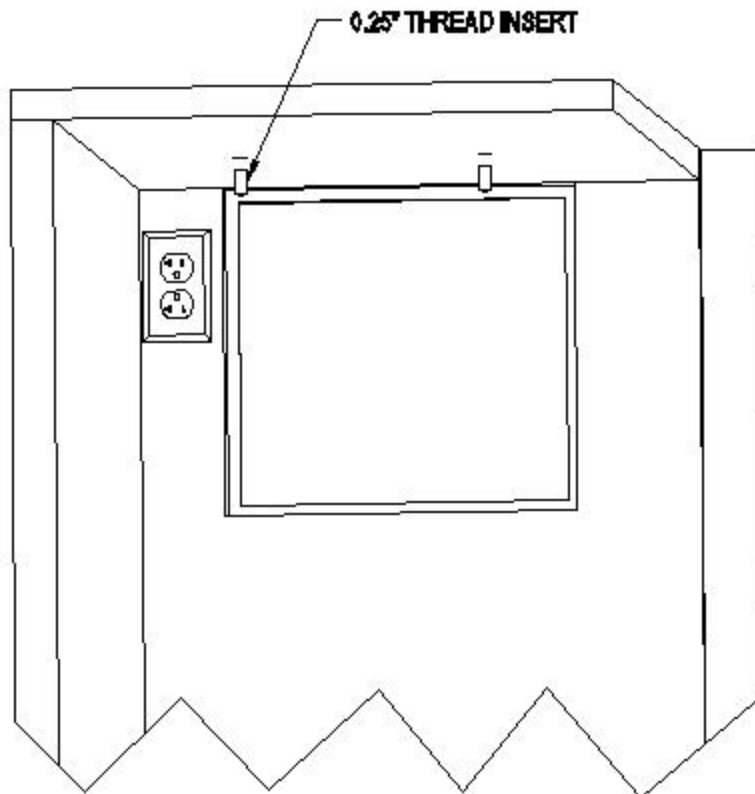

Fig. 2.2 THREAD INSERT

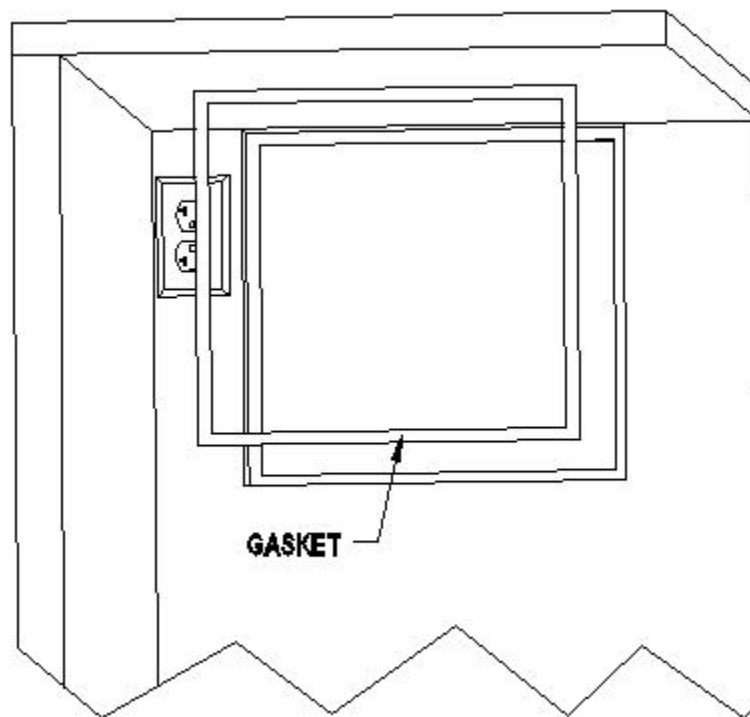

Fig. 2.3 REAR GASKET

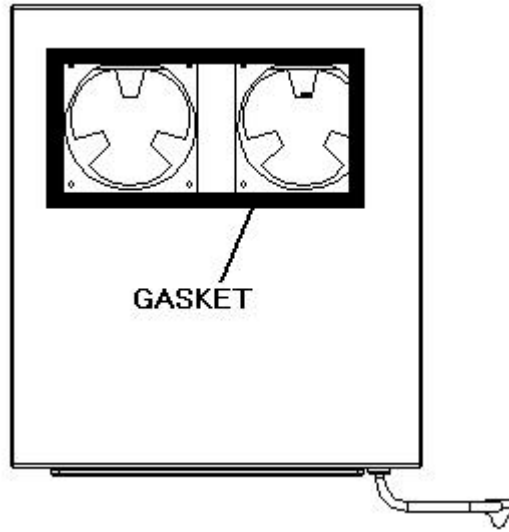

Fig. 2.4 TOP EXHAUST GASKET

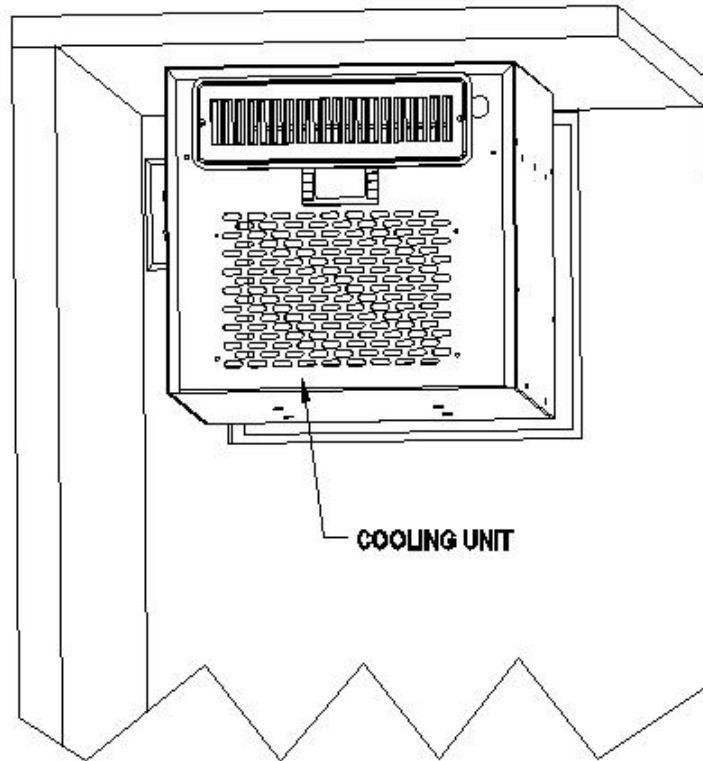

Fig. 2.5 COOLING UNIT MOUNTING

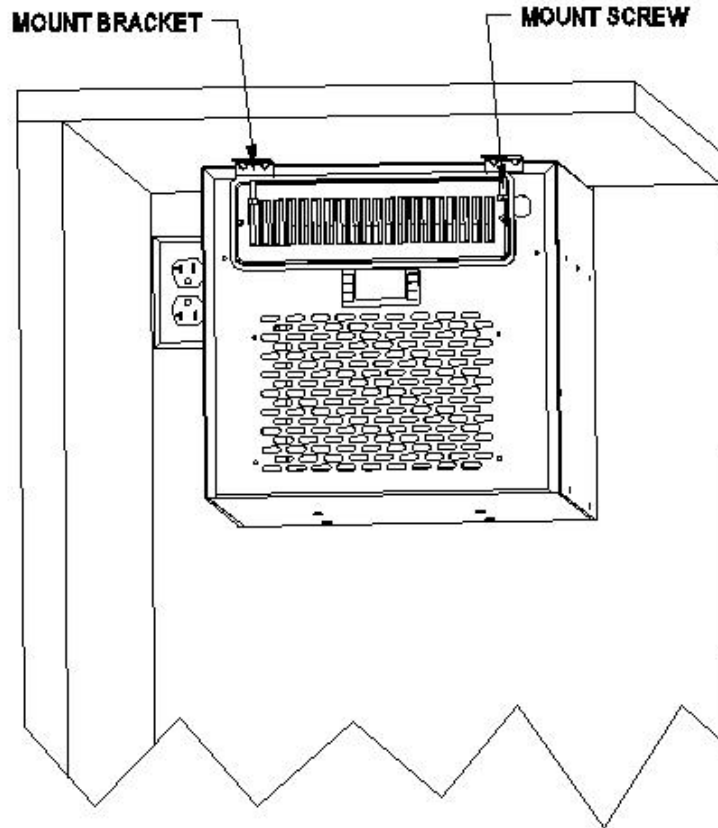

Fig. 2.6 SECURING BRACKET & SCREW

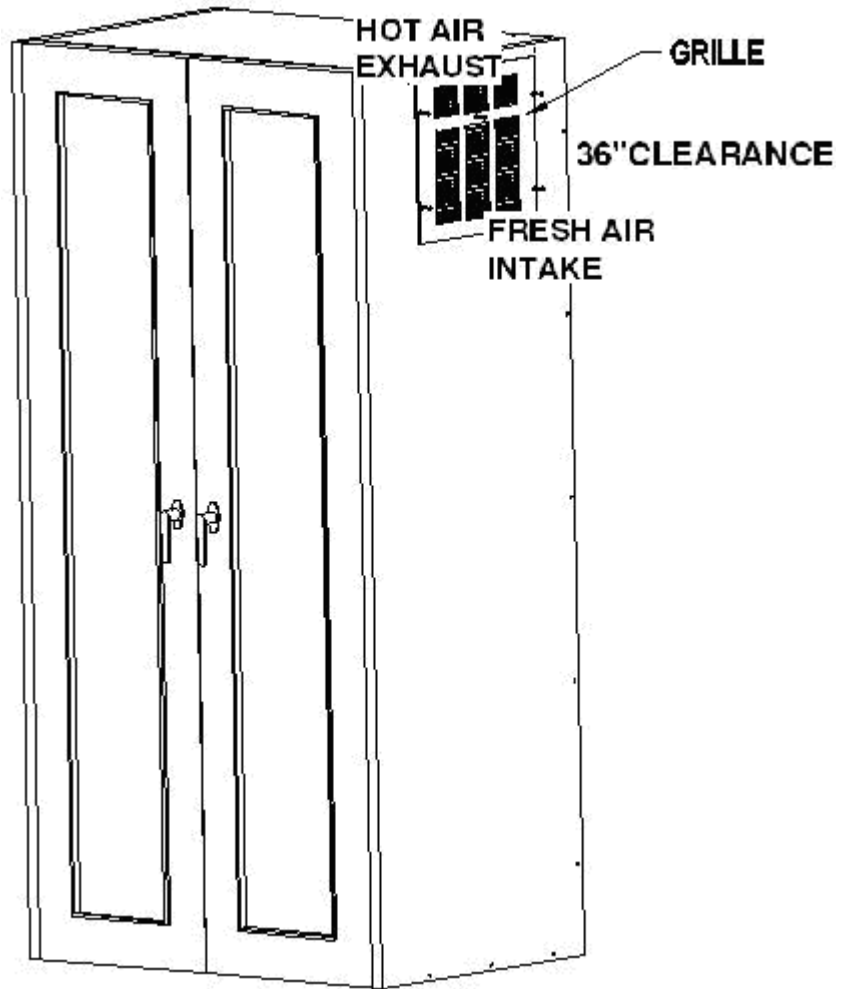

Fig. 2.7 CABINET GRILLE

3. WM-3500~8500HZD through-wall installation

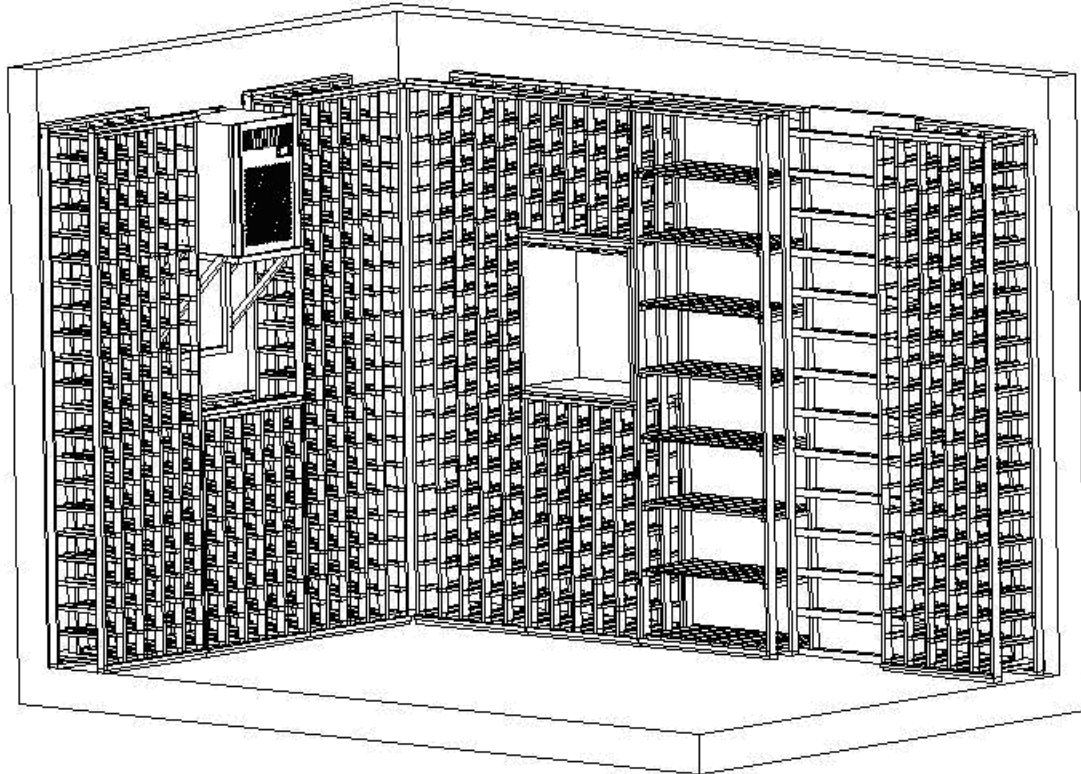

Fig. 2.8 THROUGH- WALL INSTALLATION

- The cooling unit shall be mounted near the ceiling with equal distance from each side of the room.
- Cut a rectangular opening at the wine room wall as illustrated. The dimensions of the opening shall be 1/4" larger than the width and height of the cooling unit.
- If top exhaust installation, cut another rectangular opening at the top of the room to the length and width of the top exhaust.
- Construct a shelf as shown. The shelf must be capable of supporting the weight of the cooling unit and preventing it from moving.
- Place the cooling unit on the shelf with the back of the unit flush with the outside of the wall.
- Seal the clearance between the cooling unit and opening with a high quality weather stripping, polyurethane spray foam, or foam tape. Cover the seal with molding and attach the molding to the wall not the unit.
- If top exhaust installation, place another gaskets along the top exhaust at the top of the cooling unit.
- Install a wall grille on the room exterior wall.
- Plug the unit into a properly grounded and dedicated outlet of adequate capacity.

NOTE: The cooling unit can be installed with the front of the unit flush with the inside of the wall. Construct a shelf outside the room accordingly.

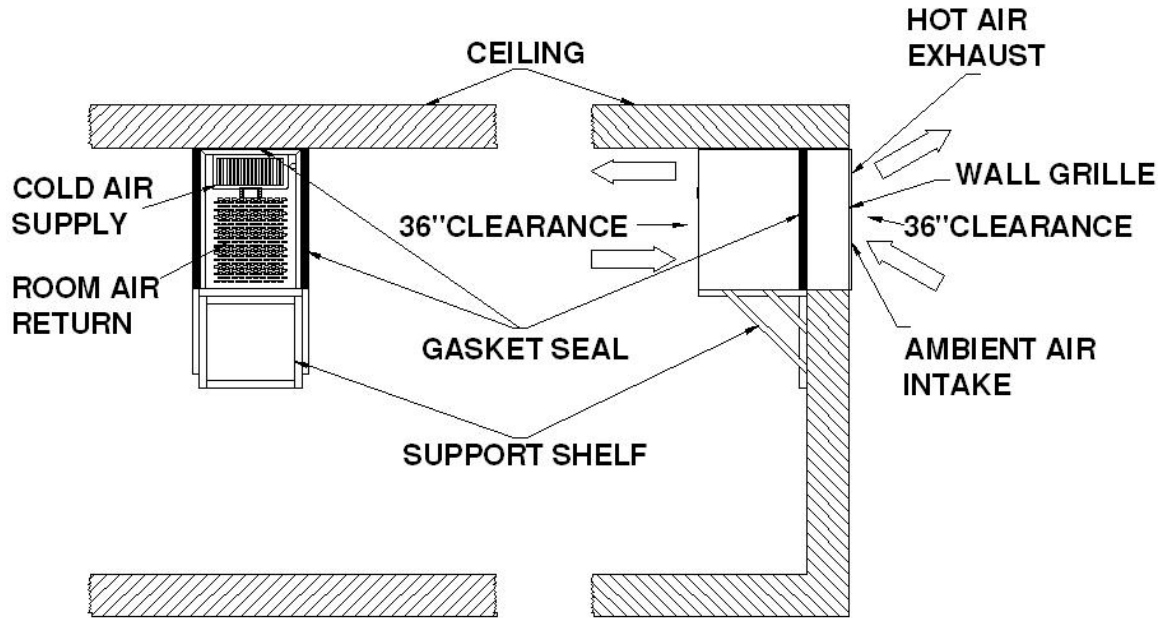

Fig. 2.9 THROUGH-WALL INSTALLATION

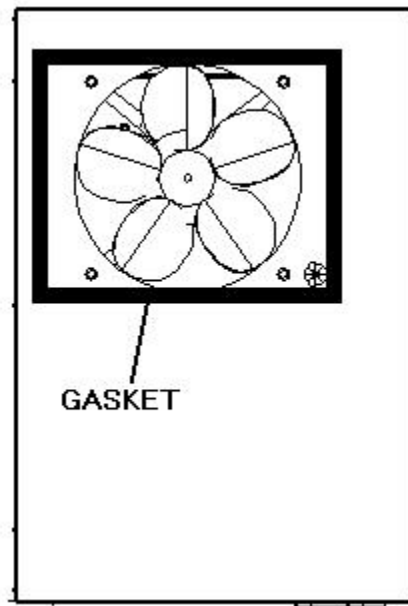

Fig. 2.10 TOP EXHAUST GASKET

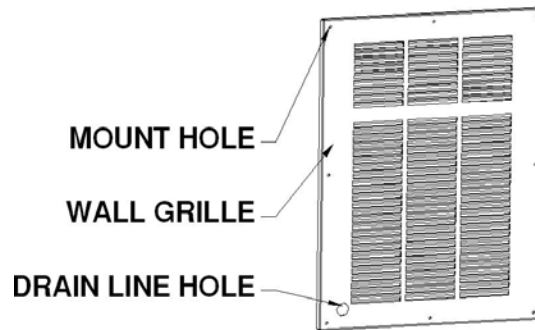

Fig. 2.11 WALL GRILLE

4. Cellar Construction

This is only a guide and shall be considered as minimum requirements.

All interior walls and floors shall have a vapor barrier and a minimum of R13 insulation. All exterior walls and ceiling shall have a vapor barrier and a minimum of R19 insulation. The vapor barrier shall be installed on the warm side of the insulation. All joints, door frames, electrical outlets or switches and any pipes or vents that go through the cellar shall be sealed to prevent air and moisture leakage into the cellar. Concrete, rock, and brick are not insulation or vapor barriers.

Doors shall be of a minimum size, insulated to at least R13 and tightly sealed with high quality weather stripping. Be sure to seal the bottom of the door and fill gap between the door's frame and wall before installing the cap molding. In order to maintain 55 °F in the wine cellar, the ambient temperature surrounding the enclosure shall not exceed the temperature of the cellar by more than 25 °F. No cellar wall shall receive direct sun or strong wind.

Lighting shall be of low wattage, with a timer to insure lights are not left on when the cellar is not occupied.

The cooling system will not be able to maintain the proper temperature if fresh moisture-laden air is constantly being introduced to the cellar. Symptoms of this condition are; cooling unit runs all the time with only a slight reduction in temperature and/or water overflows from the unit. Because of the temperature difference between the inside and outside, very small cracks can allow large amounts of outside air to enter into the cellar. Please be aware that moisture can pass through solid concrete, paint and wood. Often a newly constructed cellar contains fresh wood, paint, concrete and other building materials. These materials contain large amounts of moisture. When placed into operation in this type of environment, the system will work harder to remove this extra moisture resulting in increased "run" time.

Temperature and Humidity

1. Use of the controller



Fig. 3.1 TEMPERATURE CONTROLLER

1) Keys

SET: To display target set point; in programming mode it selects a parameter or confirm an operation.

❄️(DEF): To start a manual defrost.

⬆️(UP): To see the maximum stored temperature; in programming mode it browses the parameter codes or increases the displayed value.

⬇️(DOWN): To see the minimum stored temperature; in programming mode it browses the parameter codes or decreases the displayed value.

Ⓜ️: To turn on/off the power to the unit.

⬆️+⬇️: To lock/unlock the keypad.

SET+⬇️: To enter in the programming mode.

SET+⬆️: To return to the temperature display.

2) Lock and unlock the keys

To lock the keys, press up + down keys **⬆️+⬇️** until POF is displayed; to unlock the keys, press up + down keys **⬆️+⬇️** until PON is displayed.

3) Display

During normal operating conditions, the display shows the value measured by the air regulation probe. In case of active alarm, the temperature flashes alternately to the code alarm. The LED functions are listed as follows.

LED	MODE	FUNCTION
❄️	ON	Compressor enabled
❄️	Flashing	Anti-short cycle enabled
❄️	ON	Defrost cycle enabled
🌀	ON	Fan enabled
🌀	Flashing	Fan delay after defrost enabled
Ⓜ️	ON	Alarm occurring
°C/°F	ON	Temperature measuring unit
°C/°F	Flashing	Programming mode

4) Alarm Signals

The alarm codes are described as follows.

MESSAGE	CAUSE	FUNCTION
P1	Temperature probe faulty	Compressor switching to Con and CoF
HA	High temperature alarm	Probe temperature ALU higher than the setting temperature; Outputs unchanged
LA	Low temperature alarm	Probe temperature ALL lower than the setting temperature; Outputs unchanged
CA	External alarm	All outputs off

Probe alarms P1”, start a few seconds after the fault in the related probe; they automatically stop a few seconds after the probe restarts normal operation. Check connections before replacing the probe. Temperature alarms “HA”, “LA” automatically stops as soon as the temperature returns to normal value. Alarm “CA” (with i1F=PAL) recovers only by switching off and on the instrument.

2. Temperature Setting

- Set the temperature at 55 °F for the optimum aging of wine
- On initial start-up, the time required to reach the desired temperature will vary, depending on the quantity of bottles, temperature setting and surrounding temperature.
- Allow 24 hours to stabilize the temperature for each new temperature setting operation

3. How to see temperature set-point

- 1) Press and immediately release the **SET** key, the display will show the set-point value.
- 2) Press again and immediately release the **SET** key or wait for 5 seconds to display the probe value.

4. How to change the set-point

- 1) Press the **SET** key for more than 3 seconds until the “°C” or “°F” LED starts blinking and the set-point will be displayed.
- 2) To change the set value, press the up/down keys ▲/▼ within 10 sec.
- 3) To store the new set-point value, press the **SET** key again or wait 10 sec.

NOTE: The unit turns on at set-point **Set** plus regulation differential **Hy** after anti-short cycle **AC** has elapsed; the unit turns off at set-point **Set**.

5. How to calibrate the air probe

If the actual cellar temperature differs from the displayed temperature, set **ot** = actual cellar temperature minus displayed temperature.

6. How to adjust defrost cycle

- 1) In case the cooling unit does not stop, the parameters **FnC = C-n**, **idF = 4** and **MdF = 30** can be used to cycle off.
- 2) In case there is excessive frost, the parameters **FnC = C-y**, **idF = 6** and **MdF = 20** can be used to avoid defrost.

7. How to adjust the humidity

The parameter **Fon** is used to adjust the humidity in the wine cellar. Higher **Fon** results in higher relative humidity. Use a separate hygrometer to monitor the humidity.

8. How to set alarm call

- 1) Speech notice will be sent to your phones when the cellar temperature is **ALU** higher or **ALL** lower than the set-point **Set**.
- 2) In order to test the call function, set parameters **Ald = 0** and **dAO = 0**. After testing, set **Ald = 60** and **dAO = 23**.

9. How to set low cellar temperature heater

The heater turns on at set-point **SAA** minus regulation differential **Shy**; the heater turns off at heater set-point **SAA**.



NOTES:

- Use a forced air heater to warm up the wine cellar.
- If there is a thermostat on the heater, bypass it or set the thermostat at the highest level.
- If the heater runs more than 10 A current, use a 120VAC coil contactor.

10. Manual Defrost

Press the DEF key for more than 2 seconds and a manual defrost will start.

11. Parameter Programming

- 1) Press the **SET +**  keys for more than 3 sec until the “°C” or “°F” LED starts blinking, then release the keys.
- 2) Press again the **SET +**  keys for more than 7sec until the **Pr2** label will be displayed, then release the keys. The first parameter **Hy** will be displayed.

- 3) Press up/down keys $\blacktriangle/\blacktriangledown$ to scroll to the required parameter within 10 sec.
- 4) Press the “SET” key to display its value.
- 5) Use up/down keys $\blacktriangle/\blacktriangledown$ to change its value within 10 sec.
- 6) Press “SET” to store the new value.
- 7) **To exit:** Press **SET + \blacktriangle** or wait 15sec without pressing a key.

PARAMETER	DESCRIPTION	DEFAULT VALUE
Set	set-point (°)	55
Hy	temperature regulation differential (°)	4
AC	anti-short cycle delay (min)	10
Con	compress on with probe faulty (min)	15
CoF	compress off with probe faulty (min)	30
CF	temperature unit (°F/ °C)	F: Fahrenheit
rES	display resolution	in: integer
dLy	temperature display delay (min)	1
ot	probe calibration (°)	0
US	maximum set-point (°)	65
LS	minimum set-point (°)	50
idF	defrost cycle interval time (hour)	12
MdF	defrost cycle endurance time (min)	30
ALC	temperature alarm type	rE: relative to set-point
ALU	high temperature alarm (°)	10
ALL	low temperature alarm (°)	10
AFH	alarm recovery differential (°)	5
ALd	temperature alarm delay (min)	60
dAO	temperature alarm delay on startup (hr)	23
SAA	heater set-point (°)	40
SHy	heater regulation differential (°)	4
FnC	fan operating mode	C-n: on with compressor & off during defrost
Fon	fan on with compressor off (min)	0
FoF	fan off with compressor off (min)	15

NOTE: Depending on the unit, not all parameters are used.

Care Guide

! WARNING	
	ELECTRIC SHOCK HAZARD Disconnect the electrical power before servicing any components. Failure to do so can result in death or electrical shock.

1. Cleaning Condenser

- Clean the condenser regularly at least every 6 months.
- Condenser is located on the ambient air intake side of the cooling unit.
- Use a condenser brush or a vacuum cleaner with an extended attachment to clean the condenser.

2. Removing Condensate

Remove the excessive condensate if it is accumulated on the cooling unit in high humidity conditions.

3. Removing Unit

When you remove the cooling unit, beware water may come out of the unit.

4. Installing Drain Line

WM-3500~8500HZD units are equipped with an additional drain fitting. In case of extreme humidity there is a drain line needed, remove the drain plug on the bottom left at the rear, then remove the connection plug and fit a 0.375" OD drain tube into the drain connection. Install the cooling unit with the front higher than the rear.

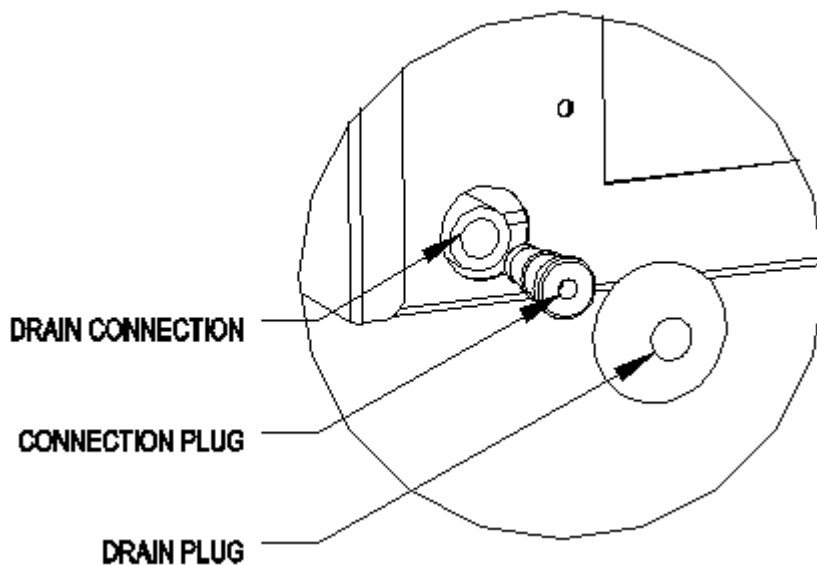

Troubleshooting

This Troubleshooting Chart is not prepared to replace the training required for a professional refrigeration service person, not is it comprehensive

Complaint	Possible Causes	Response
1. Unit not running	<ul style="list-style-type: none"> a. Power cord not plugged b. No power from supply c. Incorrect or loose wirings d. Low voltage e. Setting higher than ambient temperature f. Cut-in too high g. Defrost light blinking h. Compressor light blinking i. Defective controller 	<ul style="list-style-type: none"> a. Check power cord b. Check receptacle and fuses c. Check all wirings and connections d. Contact an authorized electrician e. Lower temperature setting f. Reduce Hy g. Unit is under defrost mode h. Unit is under anti-short cycle delay i. Call service for diagnosis
2. Unit not starting , but temperature rising high	<ul style="list-style-type: none"> a. Anti-short cycle 	<ul style="list-style-type: none"> a. Reset AC
3. Temperature fluctuating	<ul style="list-style-type: none"> a. Air probe 	<ul style="list-style-type: none"> a. When using an air probe, the wine bottle temperature is mainly controlled by the average air temperature. If the set-point is 55°F with the differential 4F, the cooling unit turns on at 59°F of air temperature (It may be higher than 59°F if it is in anti-short cycle or defrost cycle) and turns off at 55°F of air temperature. The average air temperature is 57°F, and then the wine temperature is around 57+/-0.5°F. The air is light enough to change so quickly that it maintains relatively constant average temperature that would prevent wine bottle temperature from fluctuating.
4. Temperature high, unit stopping and starting normally	<ul style="list-style-type: none"> a. Temperature setting high 	<ul style="list-style-type: none"> a. Lower the setting
5. Temperature high, unit stopping and starting with short running time	<ul style="list-style-type: none"> a. Air probe touching the evaporator coil, displaying temperature ok b. Short circuit of air flow between cold-air supply and return-air intake, displaying temperature ok c. Failed controller and probe 	<ul style="list-style-type: none"> a. Move the air probe away from the evaporator b. Deflect the supply air down c. Call service for diagnosis
6. Temperature	<ul style="list-style-type: none"> a. Improper cellar insulation & seal 	<ul style="list-style-type: none"> a. Check insulation, gasket and door

<p>high or not cooling and running continually</p>	<p>b. Cellar too large c. Ambient temperature too high d. Exhaust restricted</p> <p>e. Malfunctioning fans</p> <p>f. Evaporator or condenser airflow</p> <p>g. Dirty Condenser h. Iced evaporator i. Refrigeration system restriction j. Refrigerant leak k. Undercharge or overcharge l. Failed components</p>	<p>opening</p> <p>b. Check for excessive size c. Check installation location d. Leave minimum 3 feet clearance for the hot air exhaust side and leave minimum 1 foot clearance for the fresh air intake side</p> <p>e. Check for both evaporator and condenser fans</p> <p>f. Check for air restrictions, air short-circulation, grille directions</p> <p>g. Clean condenser h. Defrost and reset temperature i. Call service j. Call service k. Call service l. Check compressor windings, start relay and overload protector</p>
<p>7. Unit running too long</p>	<p>a. Improper cellar insulation & seal b. Exhaust restricted</p> <p>c. Cellar too large d. Ambient temperature higher > 90°F e. Dirty Condenser f. Improper condenser air flow</p>	<p>a. Check insulation, gasket and door opening b. Leave minimum 3 feet clearance for the hot air exhaust side and leave minimum 1 foot clearance for the fresh air intake side</p> <p>c. Check for excessive size d. Check for installation location</p> <p>e. Clean condenser f. Check for fan and air short circulation</p>
<p>8. Fan motor running but compressor not running</p>	<p>a. Post-compressor fan running mode b. Incorrect or loose wirings c. Failed components</p> <p>d. Liquid refrigerant in the compressor</p>	<p>a. Check fan running time FON</p> <p>b. Check all wirings and connections c. Check start relay, start capacitor, overload protector, compressor. d. Call service.</p>
<p>9. Compressor running but fan not running</p>	<p>a. Fan blade stuck b. Incorrect or loose wirings c. Failed motors</p>	<p>a. Check for proper clearance b. Check all wirings c. Call service</p>
<p>10. Temperature high, compressor stopping and starting but very short running time</p>	<p>a. Failed components</p> <p>b. Improper condenser airflow c. Dirty condenser d. Overcharge of refrigerant e. Discharge or suction pressure too high</p>	<p>a. Check compressor windings, start relay and overload protector. b. Check for condenser fan c. Clean condenser d. Call service for removing refrigerant e. Call service for information</p>
<p>11. Fan running too long</p>	<p>a. Post-compressor fan running mode for humidity modulation</p>	<p>a. Reset FON</p>
<p>12. Temperature</p>	<p>a. Low temperature setting</p>	<p>a. Raise the setting</p>

low	<ul style="list-style-type: none"> b. Low ambient temperature c. Air probe fault d. Temperature controller fault 	<ul style="list-style-type: none"> b. Move to another location c. Change a new one d. Change a new one
13.Evaporator freezing up	<ul style="list-style-type: none"> a. Evaporator air flow restriction b. Condenser air flow restriction c. Not stopping due to air leak, high ambient temperature, low temperature setting or pull-down cooling d. Defective controller or probe e. Low ambient temperature f. Initially working then stopping, moisture in the system g. Refrigerant low or leaking h. Capillary tube or expansion valve blockage 	<ul style="list-style-type: none"> a. Check for fans and CFM b. Check for fans and CFM c. Check for seal, door opening, ambient temperature and temperature setting d. Check for controller and probe e. Change defrost cycle f. Call service g. Call service h. Call service
14.Water leak	<ul style="list-style-type: none"> a. Air leak in the wine cellar (excessive condensate on the front of the cooling unit) b. High humidity c. Evaporator air flow restriction or low refrigerant d. Water passages restricted e. Drip tray leak (No water overflow but water leak) 	<ul style="list-style-type: none"> a. Check for any air leak b. Use drain line c. Check supply air flow or air TD crossing evaporator d. Clean the drip tray e. Seal the leak using silicone sealant
15.Circuit tripping	<ul style="list-style-type: none"> a. Incorrect fuse or breaker b. Incorrect wirings c. Failed components 	<ul style="list-style-type: none"> a. Check for proper fuse or breaker b. Check for wirings and connections c. Call service
16.Noisy operation	<ul style="list-style-type: none"> a. Mounting area not firm b. Loose parts c. Compressor overloaded due to high ambient temperatures or airflow restriction d. Defective components 	<ul style="list-style-type: none"> a. Add support to improve installation b. Check fan blades, bearings, washers, tubing contact and loose screws. c. Check for airflow d. Call service for checking internal loose, inadequate lubrication and incorrect wirings

Electrical Wiring Diagrams

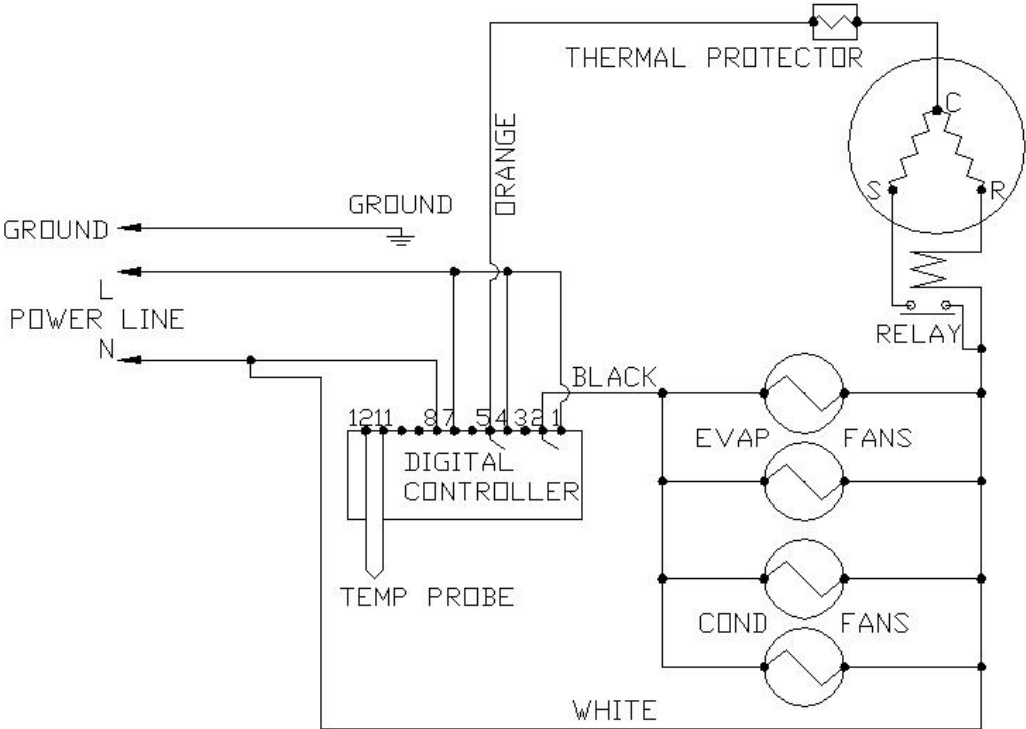

Fig. 6.1 WM-1500~2500HZD WIRING DIAGRAM

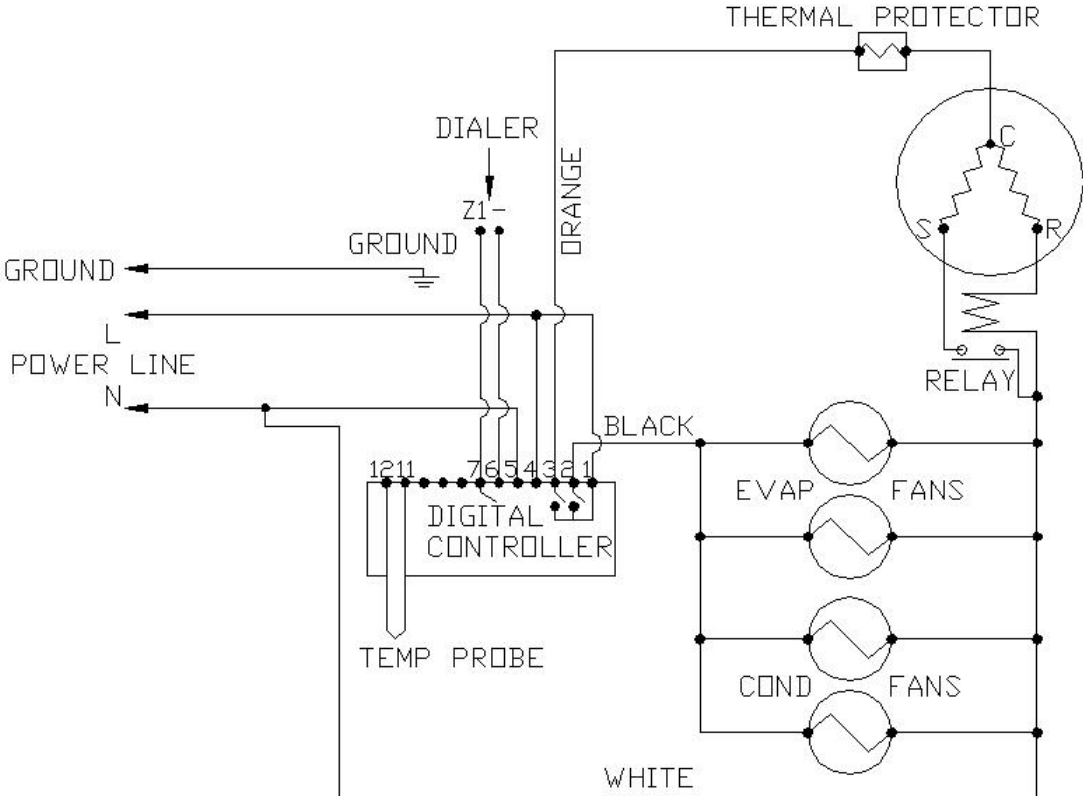

Fig. 6.2 WM-1500~2500HZD WIRING DIAGRAM (ALARM CALL)

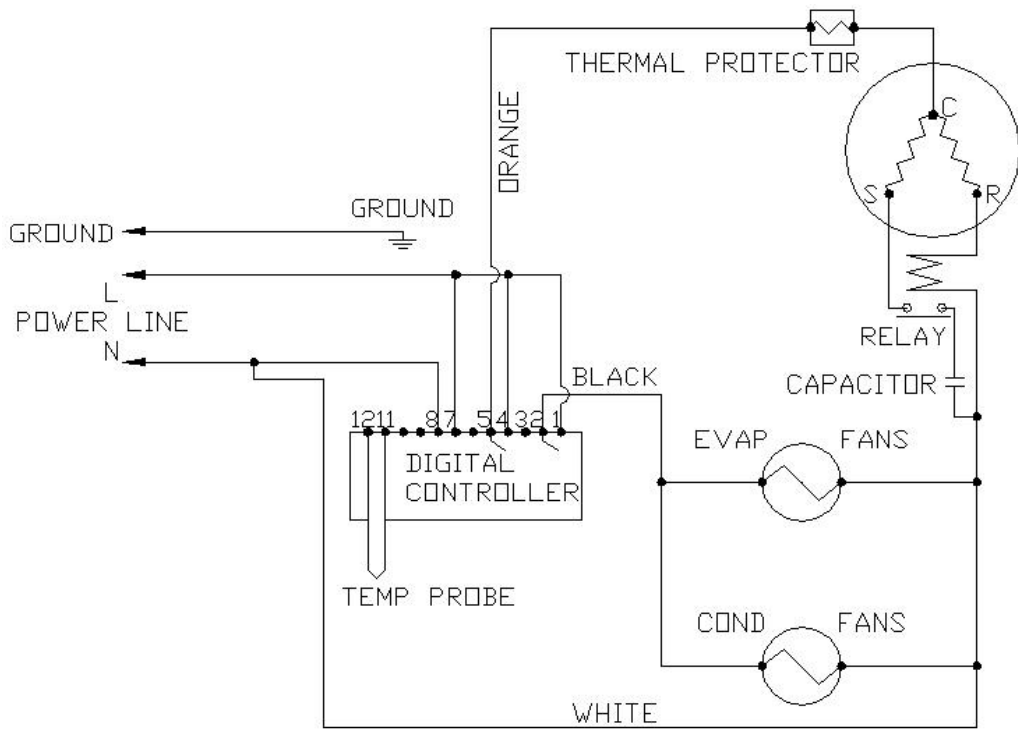

Fig. 6.3 WM-3500~8500HZD WIRING DIAGRAM

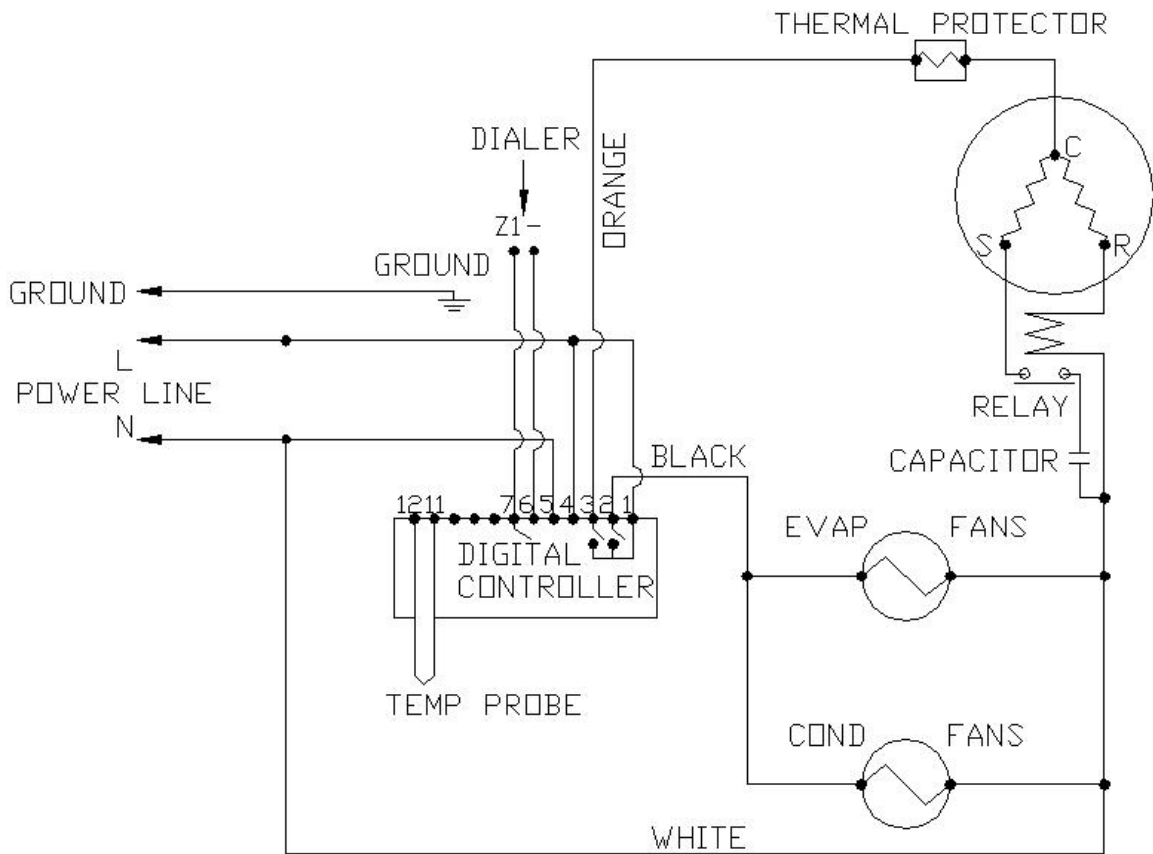

Fig. 6.4 WM-3500~8500HZD WIRING DIAGRAM (ALARM CALL)

Customer Support

If you need further assistance, please contact us at:

Vinotemp International
17631 South Susana Road
Rancho Dominguez, CA 90221
Tel: (310) 886-3332
Fax: (310) 886-3310
Email: info@vinotemp.com

Warranty

Thank you for choosing a Vinotemp cooling unit.

Please enter the complete model and serial numbers in the space provided:

Model _____
Serial No. _____

Attach your purchase receipt to this owner's manual.

1. Limited Warranty

VINOTEMP warrants its products to be free from defects due to workmanship or materials under normal use and service, for twelve months after the initial sale. If the product is defective due to workmanship or materials, is removed within twelve months of the initial sale and is returned to VINOTEMP, in the original shipping carton, shipping prepaid, VINOTEMP will at its option, repair or replace the product free of charge. Additionally VINOTEMP warrants all parts to be free from defects for a period of sixty months after initial sale.

This warranty constitutes the entire warranty of the VINOTEMP with respect to its products and is in lieu of all other warranties, express or implied, including any of fitness for a particular purpose. In no event shall VINOTEMP be responsible for any consequential damages what is so ever. Any modification or unauthorized repair of VINOTEMP products shall void this warranty.

Service under Warranty

This service is provided to customers within the continental UNITED STATES only. VINOTEMP cooling units are warranted to produce the stated number of BTU/H. While every effort has been made to provide accurate guidelines, VINOTEMP can not warranty its units to cool a particular enclosure.

In case of failure, VINOTEMP cooling units must be repaired by the factory or its authorized agent. Repairs or modifications made by anyone else will void the warranty.

Shall a VINOTEMP cooling unit fail, contact the dealer for instructions, do not return the unit to the factory without authorization from VINOTEMP. If the unit requires repair, re-pack it in the original shipping carton and return it to the factory, shipping prepaid. VINOTEMP will not accept COD shipments. If the unit

is determined to be faulty and is within the twelve month warranty period VINOTEMP will, at its discretion, repair or replace the unit and return it free of charge to the original retail customer. If the unit is found to be in good working order, or beyond the initial twelve month period, it will be returned freight collect.

2. Limitation of Implied Warranty

VINOTEMP'S SOLE LIABILITY FOR ANY DEFECTIVE PRODUCT IS LIMITED TO, AT OUR OPTION, REPAIRING OR REPLACING OF UNIT.

**VINOTEMP SHALL NOT BE LIABLE FOR:
DAMAGE TO OTHER PROPERTY CAUSED BY ANY DEFECTS IN THE UNIT,
DAMAGES BASED UPON INCONVENIENCE, LOSS OF USE OF THE UNIT,
LOSS OF TIME OR COMMERCIAL LOSS, ANY OUTER DAMAGES,
WHETHER INCIDENTAL, CONSEQUENTIAL OR OTHERWISE.**

THIS WARRANTY IS EXCLUSIBE AND IS IN LIEU OF ALL OTHER WARRANTIES, EXPRESSED OR INPLIED, INCLUDING BUT NOT LIMITED TO, IMPLIED WARRANTIES OF MERCHANTABILITY OR FITNESS FOR A PARTICULAR PURPOSE.

While great effort has been made to provide accurate guidelines VINOTEMP cannot warrant its units to properly cool a particular enclosure. Customers are cautioned that enclosure construction, unit location and many other factors can affect the operation and performance of the unit. There for suitability of the unit for a specific enclosure or application must be determined by the customer and cannot be warranted by VINOTEMP.