

INDUSTRIAL 6" HANDLE PULL

HIP-0600

- Break to length screws
- Fits materials from 1/2" to 1-1/2" thick

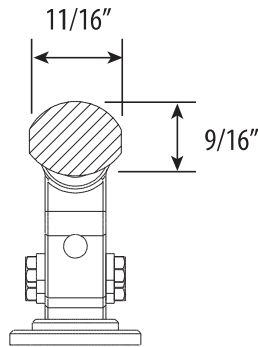
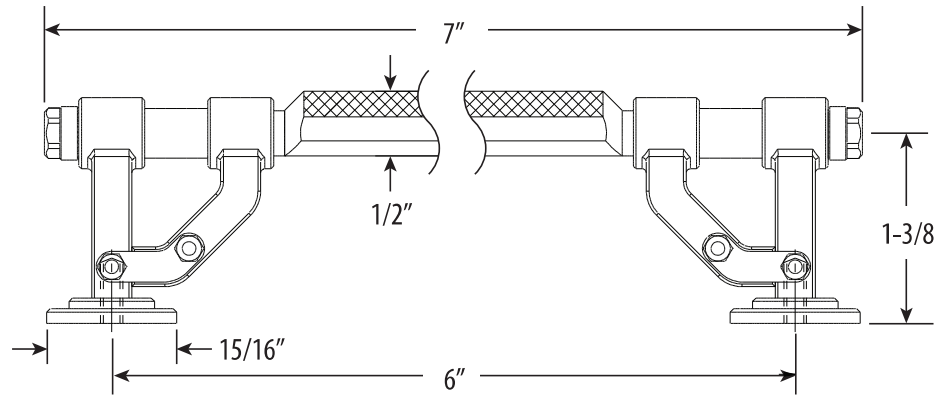

END VIEW

DIMENSIONS MAY VARY AND ARE SUBJECT TO CHANGE. NO RESPONSIBILITY IS ASSUMED FOR USE OF SUPERCEDED OR VOIDED DATA