

WATERMARK

BROOKLYN, NEW YORK

Anika 30-2-TR25

Deck Mounted Widespread Lavatory Faucet



- Flow Rate: 1.2 GPM, other flow rates available
- Includes MPU5 Soft Touch Drain
- Recommended Hole Size: 1 3/8"
- Maximum Deck Thickness: 1 3/4"
- Lead-free brass construction with Fluehs quarter-turn ceramic valves
- Professional installation required

Available in all finishes shown on the [Watermark Designs website](#)

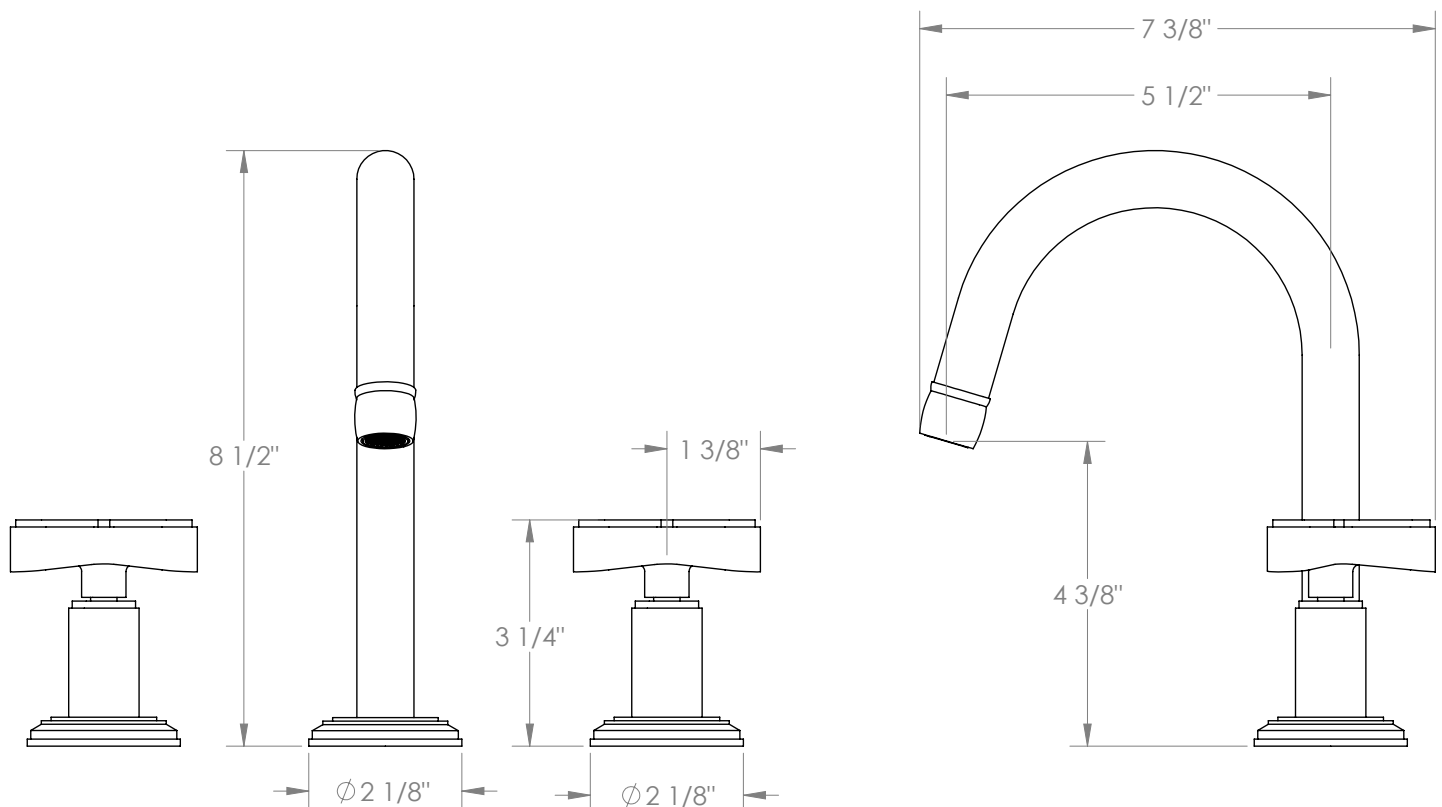

Meets the applicable requirements of ASME A112.18.1/CSA B125.1, entitled "Plumbing Supply Fittings".

Watermark Designs reserves the right to make revisions without notice to product specifications. All product dimensions are nominal.

03/2024

350 Dewitt Ave. Brooklyn, NY 11207 USA | T: 1 718 257 2800 | F: 1 718 257 2144 | customerservice@watermark-designs.com