

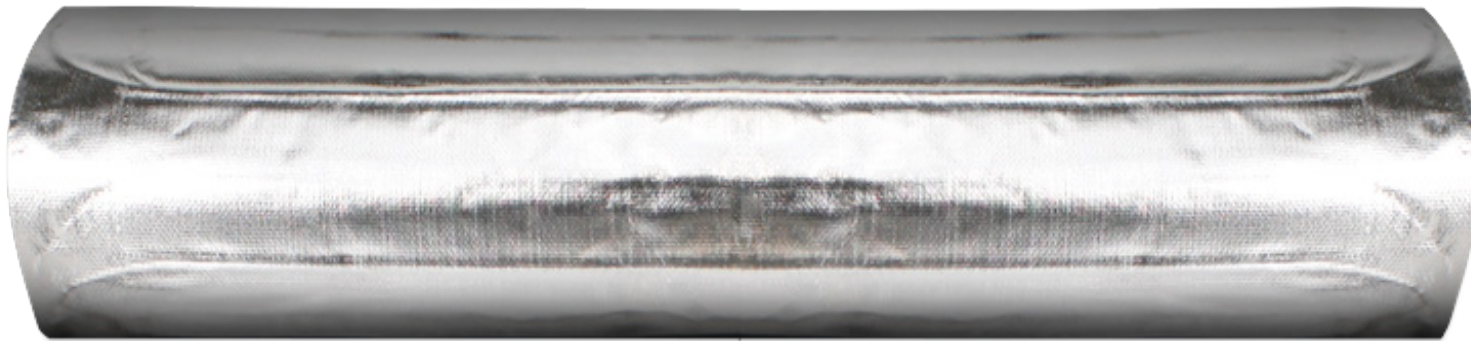

Installation Manual for your Environ™ Flex Roll System For laminate/floating wood & engineered wood floor coverings



Please read through these instructions carefully before you begin installing & check that you are aware of all the components required.

CONTENTS

Product specifications and details	1
Introduction	2
Important Information	2
Controlling Your System	3
Professional Electric Installation.....	3
Items required for System Installation	3
Testing	4
Pre Installation Instructions	4
Compatible Underlayment.....	5
Compatible Wood Laminates	5
Installing the Thermostat	6
Installation of Environ™ Flex Rolls.....	7
Environ™ Flex Rolls Rules.....	8
Installation Environ™ Flex Rolls under Carpet.....	9-12

PRODUCT SPECIFICATIONS AND DETAILS

Environ™ Flex Roll System

Environ™ Flex is an ultra thin electric radiant floor heating roll, primarily used under laminate and engineered wood.

The advantage of Environ™ Flex is the ease of installation and the even heating of your flooring. The roll is produced with materials that avoid restricted heating known as, “hot spots.”

Construction

The Environ™ Flex system is manufactured with fluoropolymer insulated heating cables with reinforced metal braiding over two heating cores. The fluoropolymer insulated heating cables are designed to be in between two layers of reinforced and durable aluminum. The uniform spacing of the heating elements, strengthened by the foil, ensures even heat distribution. The heating element is connected to a power-supply cable, which is located in one corner of the roll. The power lead is a flat thin two-core flexible cord, consisting of two insulated conductors with a metal sheath and an outer sheath. Environ™ Flex is supplied within the nominal heat output range of 140 W/m^2 (12 W/ sq. ft.) @ 120 V & 240 V. The power lead is 15 feet long.

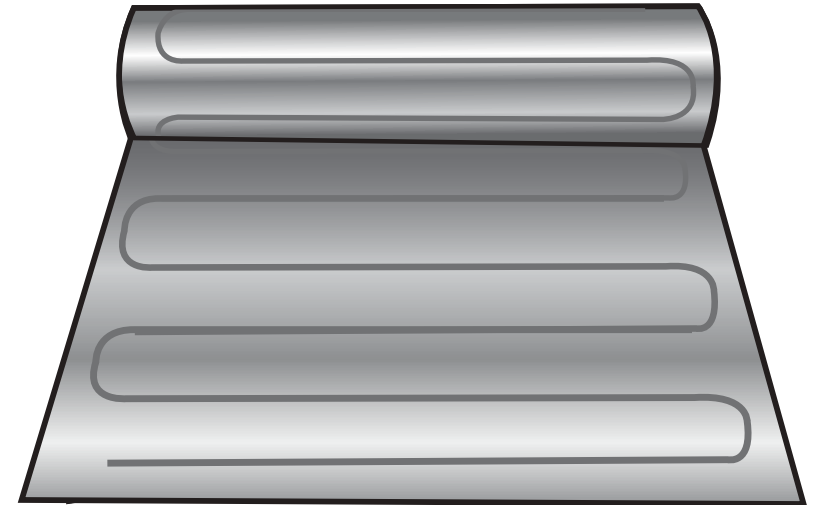

Metal Braiding
Connected to Ground

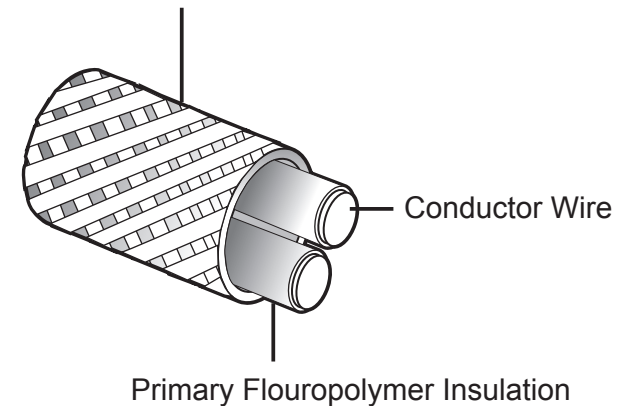

Introduction

Thank you for purchasing the Environ™ Flex Roll System. This manual contains **IMPORTANT** information regarding the safe use and installation of your Environ™ Flex Roll System. Please read through the entire manual carefully before you install or operate your floor heating system.

Important Information

- Environ™ Flex Rolls are designed for installation directly under laminate/ floating wood and engineered wood, installed on top of an underlayment.
- Environ™ Flex Rolls are NOT designed for installation under ceramic tile, natural stone or other similar hard floor coverings; and MAY NOT be installed under nailed hardwood flooring. WarmlyYours sells products to heat these flooring surfaces – Contact us at: info@warmlyyours.com, or (800) 875-5285 for more information on other floor heating system options available.
- Environ™ Flex Rolls should be separated from other heat sources such as luminaries and chimneys.
- The minimum distance between adjacent runs should be at a minimum of 1.5" (40 mm).
- Do not install the Environ™ Flex Rolls at an ambient temperature below 5°F (-15°C).
- Environ™ Flex Rolls should not extend beyond the room or area in which it originates, as per the custom installation SmartPlan™.
- The Environ™ Flex Rolls must be spaced from the walls a minimum distance of 3" (76 mm).
- Certain underlayment types and thicknesses with laminates/floating wood are NOT compatible with Environ™ Flex Rolls (see page 5). DO NOT PLACE EXCESSIVELY HEAVY FURNITURE on your heated floor.
- Environ™ Flex Rolls must not be installed under cabinets or furniture that will be permanently installed and attached to the floor. Built-in cabinets and other furniture with solid bases must not be placed over the rolls.
- Environ™ Flex Rolls is not for installation in walls.
- Environ™ Flex Rolls should NOT be installed on top of other in-floor radiant heating systems (for example hydronic or in-slab systems) UNLESS the other system is permanently disconnected in such a way that it cannot be inadvertently switched on while the Environ™ Flex Rolls are also in use.
- The Environ™ Flex Rolls may NOT be installed on floors where radiant ceiling heating rolls are in use in the room directly below where the Environ™ Flex Rolls are installed.
- Environ™ Flex Rolls must not be installed in thinset cement, or in direct contact with a cement or concrete subfloor or slab. There must be an underlayment under Environ™ Flex Rolls.
- Indicate which branch circuits supply the power to the Environ™ Flex Rolls and retain the UL labels for each heating roll in a convenient location, i.e. taped to the circuit breaker box, for reference by the electrical inspector or home owner. Leave one UL label attached to the Environ™ Flex Rolls. Attach warning label in a convenient location to show the room location where Environ™ Flex is installed.
- Use only listed conduit, fittings, and/or other listed components.
- In Canada, the installation should be done according to the provisions of the Canadian Electrical Code, Part 1, Section 62.
- When used in wet locations, the installation should be in accordance with the National Electric Code, NFPA-70 and CAN/CSA-C22.1, Canadian Electrical Code, Part I (CEC) and that final acceptance is to be made in the field by the Authority Having Jurisdiction (AHJ).
- Environ™ Flex Rolls should be connected to a CLASS-A Ground Fault Circuit Interrupter (GFCI). Some local electrical codes may require that a qualified electrician connect the system.

We want your installation to be trouble-free. If you are confronted with a problem you cannot solve, please do not hesitate to contact us at: info@warmlyyours.com, or call us any time, any day at (800) 875-5285.

Controlling Your System

WarmlyYours recommends a Class-A GFCI, UL/CSA/ETL or similar NRTL listed thermostat to control the Environ™ Flex Rolls. A programmable thermostat will allow you to set your floor warm-up time and will provide you increased energy efficiency, by programming your wake up, away, bedtime, and vacation settings.

Most wood laminate manufacturers specify that their floors should not be subjected to temperatures in excess of 85°F (29°C). The only reliable way to achieve this is to install a temperature sensor directly under the Environ™ Flex Rolls. Check with your laminate manufacturer to see their recommendations for installing electric radiant heat under their floors.

Any of the thermostats from the WarmlyYours nSpiration Series can be set to the temperature recommended by the laminate manufacturer.

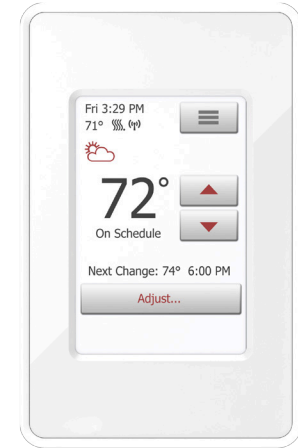

Professional Electric Installation

Attention: Some local codes require that a licensed electrician complete the final connection of the floor heating system.

The installation of electrical systems presents a risk of fire and electrical shock, which may result in personal injury. Caution should always be taken to guard against these risks. A qualified electrician should connect Environ™ Flex Rolls to the thermostat and/or to the electrical supply circuit. All such connections MUST be in accordance with the National Electric Code, Canadian Electric Code, and all local codes.

WarmlyYours strongly suggests a dedicated circuit for each system. A non-dedicated circuit can cause nuisance tripping of the GFCI built into the thermostat.

Items Required For System Installation

- The customized installation SmartPlan™ (floor plan layout)
- Ground Fault Circuit Interrupter (GFCI)
- Digital Ohm Meter (multi-meter)
- 4" x 4" extra-deep box with a single gang plaster ring
- Junction box for systems requiring more than 3 rolls
- Wire and appropriate-sized, non-GFCI breaker for supplying voltage
- Electrical conduit
- Adhesive tape
- Aluminum tape strips

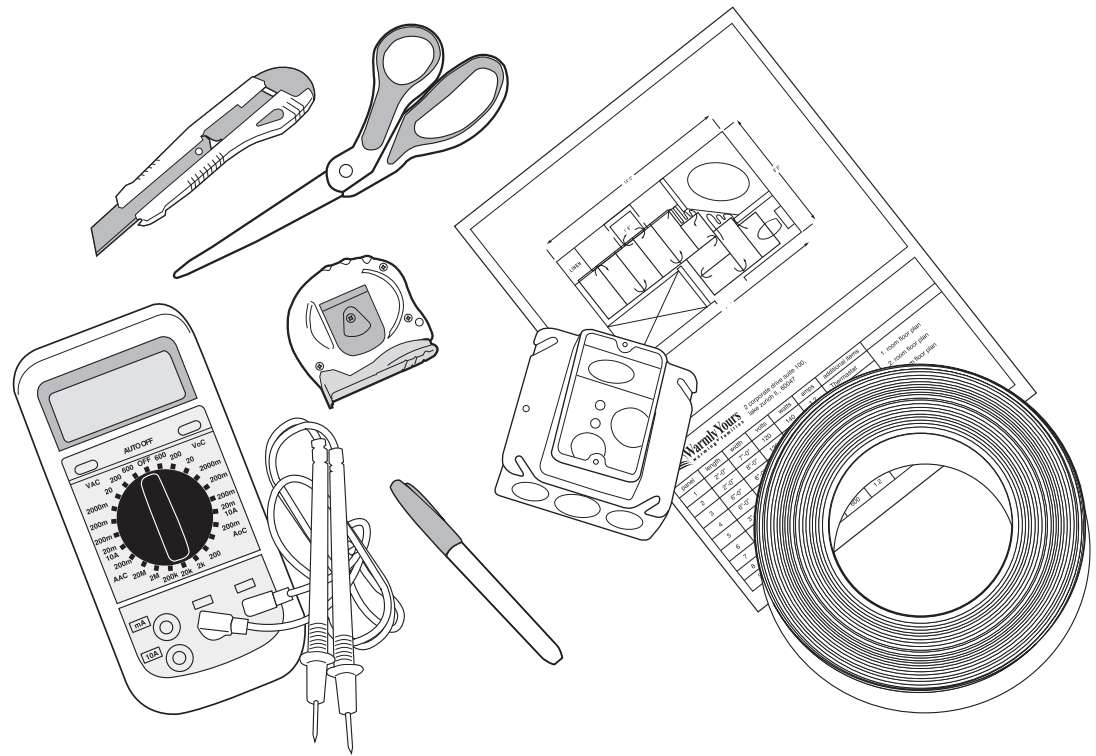

Testing

Temperature sensor wire must be tested before and after installation and must measure between 8k to 12k ohm for temperatures between 68-86 F (20-30C). This measurement must be done with a digital ohm meter, set to the 20k range. Beware of self-ranging meters and analog meters.

Each Environ™ Flex Roll is carefully tested before it is shipped from the factory, and is packed to avoid damage during transit. However, damage does sometimes occur in storage or transit, and sometimes during installation. We strongly recommend you test the rolls:

- After unpacking the rolls but before you install them.
- After you have installed them but before you install the floor covering (i.e. while the rolls are still exposed)
- After installation of the floor covering but before the thermostats are connected.

A simple test is a visual inspection to make sure there is no visible damage to the heating element, and in particular to the cable component in the heater. We recommend conducting an electrical test with an ohm meter to ensure that the ohms resistance is what it should be. Ohms resistance can vary significantly depending on the ambient temperature and an allowance of -5% to +10% from the nominal value at 68°F (20°C) is acceptable.

Pre-Installation Instructions

Ensure the subfloor is structurally sound, and is clean and dry.

It shall be noted that most wooden subfloor manufacturers (and also the wood floor manufacturers) restrict the level of moisture content as well as Relative Humidity for installing and maintaining sturdy subfloors. Strictly follow the wooden floor/subfloor manufacturer guidelines for proper installation and maintenance of wooden subfloors in order to avoid any horizontal or vertical movement of the subfloor and consequential damage to your Environ™ Flex floor heating system.

To prevent damage to the rolls, special attention should be given to ensure that no nails, screws, staple, or tacks are protruding from the sub floor before the underlayment is installed. Take extra caution, if you use an automatic staple gun to secure the cushion/underlayment to the subfloor, a badly installed staple could protrude from the floor and pierce and damage the Environ™ Flex Rolls.

Nails, screws, or staples should not be installed close to the rolls and power supply cables. Permanent fixtures, including built-in furniture, must NEVER be installed on top of the rolls.

It is important to keep an accurate record of where the rolls are installed, to assist you (and a future owner) to easily locate them; we suggest that you capture a few photographs during the installation process, and ALWAYS save your custom installation SmartPlan™.

OHM Testing

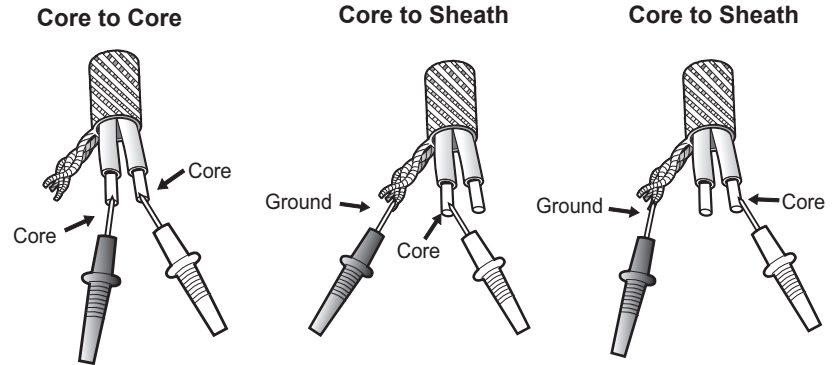

Compatible Underlayments

Any type of underlayment/padding may be used as long as it has a density of 6-8 pounds per cubic foot.

Certain underlayment, such as ¼" (6mm) thick cork, or 5mm CeraZorb are recommended for Environ™ Flex Rolls. It is also acceptable to place a vapor barrier, such as a plastic sheet, under the underlayment. Underlayment papers are not compatible with Environ™ Flex Rolls.

Underlayment is necessary to prevent Environ™ Flex Rolls from damage from the weight of the floor, furniture, and people. Unavoidable wooden floor movements will not harm Environ™ Flex Rolls. Wooden floors expand and contract with temperature and moisture change. The wooden floor "moves" on top of Environ™ Flex Rolls. This movement will not damage Environ™ Flex Rolls when the installation is done correctly and the underside of the final floor covering is installed evenly.

Some underlayment materials also have a noise reducing and insulating effect. When installing over concrete, a ¼" underlayment is mandatory. Any underlayment available in ¼" size is acceptable in most cases. CeraZorb, cork, or ¼" to 3/8" of expanded polystyrene (EPS) with a density of 2 pounds per cubic foot or more, are recommended for installation under Environ™ Flex Rolls. When installing over a concrete slab, choose the underlayment with the highest R-Value.

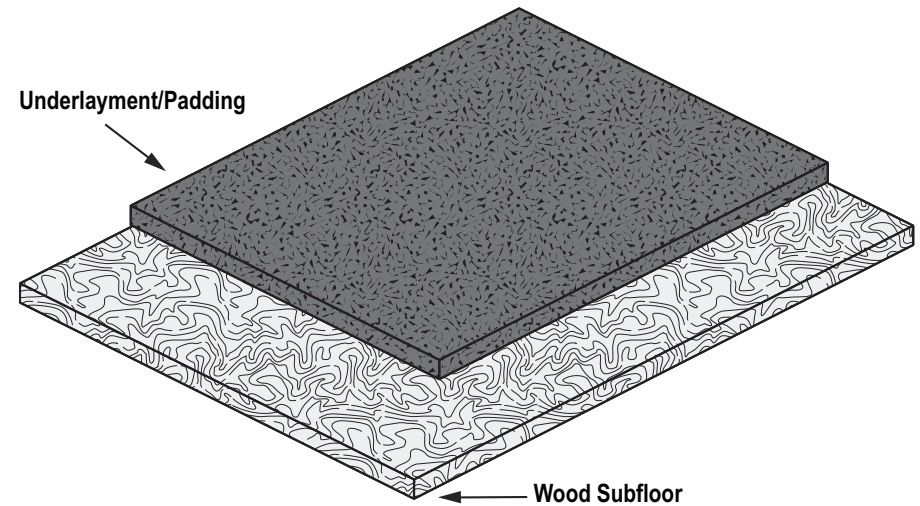

Compatible Wood Laminates

Verify that your laminate is warranted for use with radiant heat. Most modern wood laminate floors are compatible with Environ™ Flex Rolls, but the maximum thickness of the timber / laminate / wooden flooring should not exceed 5/8" (15mm). Flooring that has metallic strips as part of its locking system is NOT compatible, as these metallic strips may damage the Environ™ Flex Rolls. Also laminates that have their pad already attached to the laminate are not compatible with the Environ™ Flex Rolls.

R-Value of Floor Covering:

The type and thickness of the floor covering materials used with this product must not exceed a thermal insulation "R" value of 1.

Example R-values: LAMINATE FLOORING = R 0.675

WOOD FLOORING = R 0.80 maximum

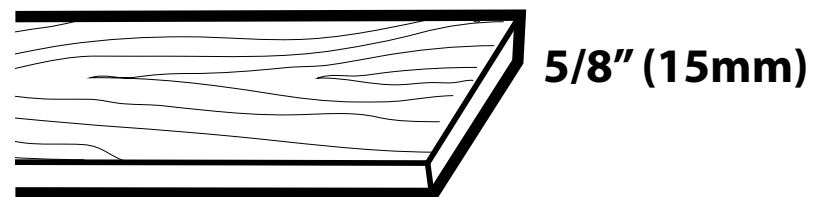

Installing The Thermostat

If you are using a thermostat with a floor sensor, place the sensor under the Environ™ Flex Rolls, centered between two heat wires, at least 6" (150 mm) into the heated area.

Make a small divot in the underlayment in this spot and secure the sensor head in the divot with tape. Run the sensor cable in a channel cut into the underlayment from the heater and back to the thermostat. The "heater wires" within the roll are identified as raised parallel lines. The sensor wire should not cross over the foil heater wires, and is better placed in a channel cut into the underlayment, under the roll.

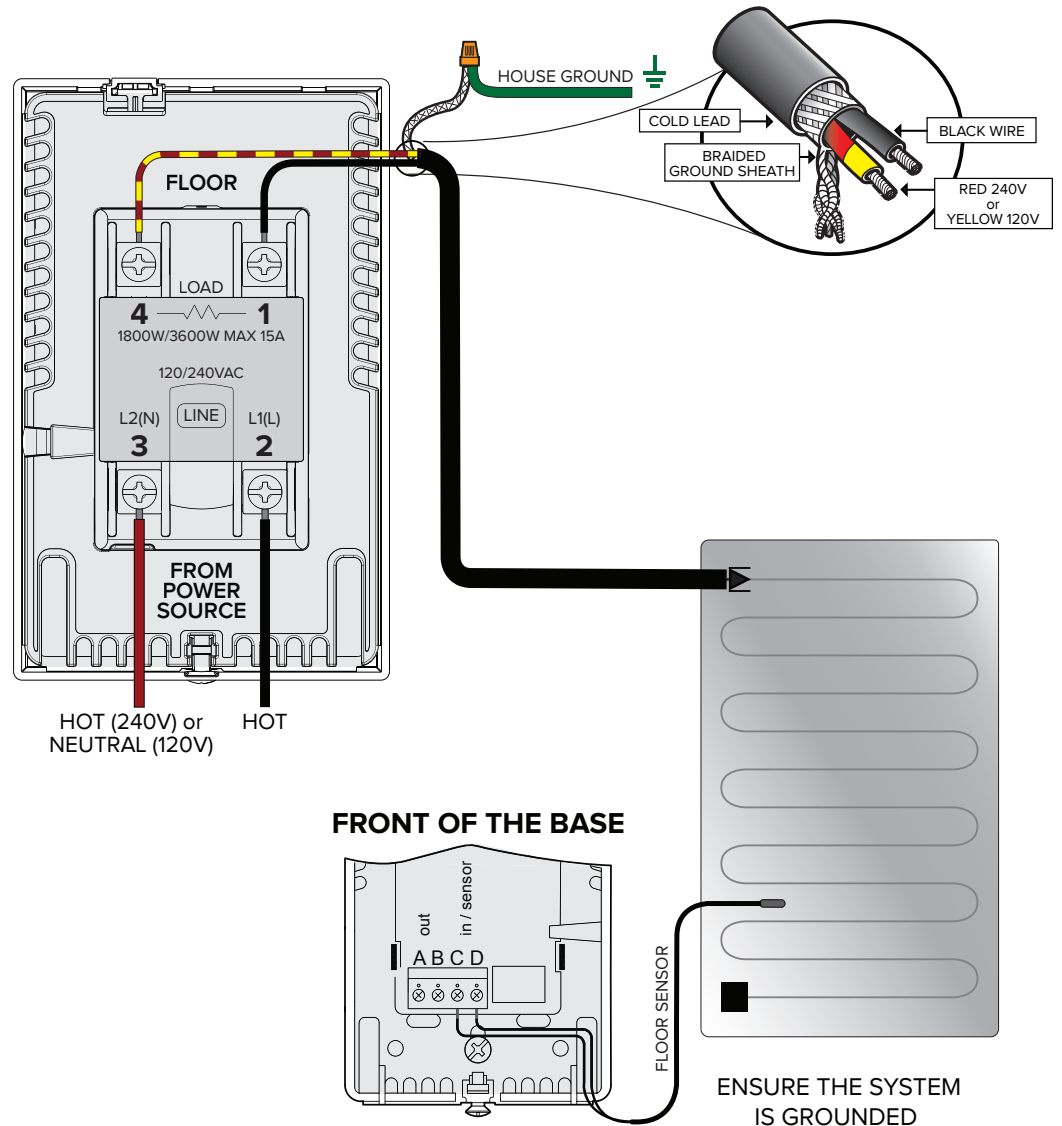

Environ™ Flex Rolls should be connected to a CLASS – A Ground Fault Circuit Interrupter (GFCI) / Residual Current Device (RCD). Consult a qualified electrician.

Installation of Environ™ Flex Roll System

- Once the underlayment has been installed in the correct manner, remove your Environ™ Flex Rolls from the box, unroll it completely and place it in the required position on top of the underlayment.
- Make sure that Environ™ Flex Rolls are installed with the correct orientation. Ensure that the side marked “THIS SIDE UP” is facing upwards.

When positioning the roll on the underlayment, be aware of the following:

- Ensure the power supply cables can reach the thermostat to which it will be connected.
- Wherever possible, run the power supply cables parallel or at right angles to the walls, and avoid high-traffic areas.
- Wherever possible, keep the corner where the power supply cable enters the roll away from high traffic areas.
- NEVER run the power supply cables under or over the rolls.
- The power supply cables (non-heating leads) must be installed in accordance with applicable National Electric Codes, Canadian Electric Codes, and local codes.
- The power supply cables (non-heating leads) are to be installed in listed conduit as the cables exit the floor if required by local code.
- Environ™ Flex Rolls can be cut and turned at 90° or 180° (as shown in the bottom picture) to cover the total area (cable should not be cut)
- Ensure that there is a minimum gap of 1.5” (40mm) between heating cables in adjacent runs of mat.

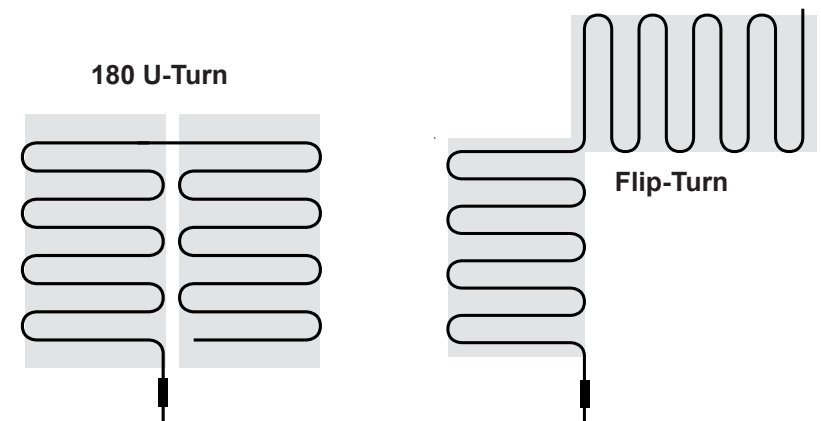
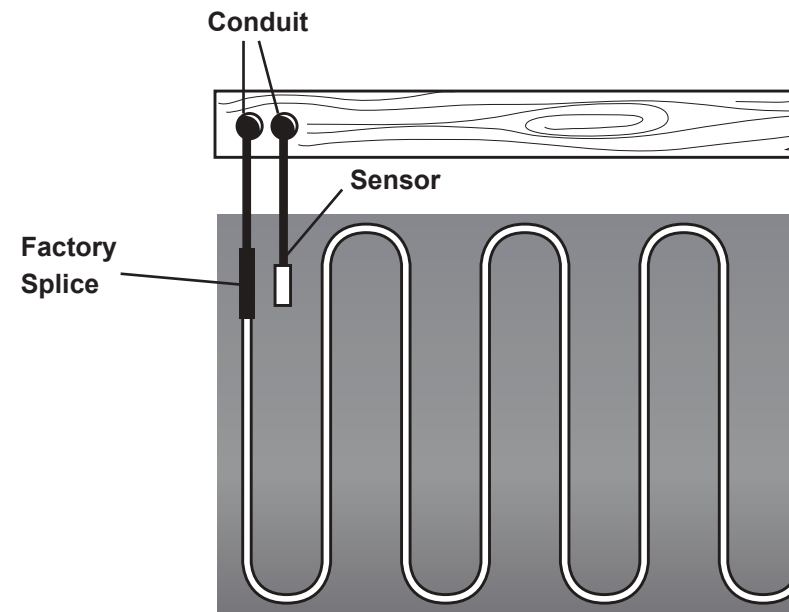

Environ™ Flex Rolls MUST NEVER BE CUT OR TRIMMED TO FIT INTO A SPACE THAT IS TOO SMALL FOR THE ROLL SIZE

Smooth out the roll and adhere the roll to the underlayment with adhesive tape or aluminum tape strips. After deciding the route that your power supply cables will take from the roll to the point of supply, cut a ¼" (6 mm) wide channel in the underlayment along this route and drop the power supply cables into this channel (See Figure 1). Similarly you have to cut a small section / channel in underlayment or laminate depending on the position of thermostat floor sensor. You may also need to remove a small section of underlayment from under the roll at the point where the power supply cord enters the roll, to prevent excessive wear on that part of the roll.

When installing two or more Environ™ Flex Rolls next to each other, make sure that the heating wires in adjacent rolls do not overlap. We recommend the use of adhesive tape to assure that they will not overlap over a period of time.

Environ™ Flex Rolls must be fit directly on top of the underlayment, and directly under the flooring.

To avoid damage to your rolls during installation, care must be taken so that tools with sharp edges or points are not dropped or used carelessly on top of the rolls. Do not walk on the rolls more than is absolutely necessary during installation, and do not drop or place heavy materials on the rolls.

Environ™ Flex Rolls must not be folded, and care should be taken in order to not fold or crease the rolls at any time during installation. For this reason Environ™ Flex Rolls are not suitable for use on stairs. Should you wish to move your roll(s) at some later stage, please remember to roll it rather than folding it.

Note: These installation instructions are NOT intended to replace or supersede the installation instructions provided by the manufacturer of the wood laminate, but to supplement them.

You should comply with BOTH sets (floor covering and floor heating) of installation instructions.

In the event of any apparent contradiction between the Environ™ Flex instructions and the floor covering manufacturer's instructions, kindly contact WarmlyYours for clarity on how to proceed, (800) 875-5285.

NOTE: A qualified, licensed electrician in accordance with local building and electrical codes, and the National Electric Codes, Canadian Electric Codes, and local codes, especially Article 424, Part IX of the NEC, ANSI/NFPA 70 and Section 62 of CEC Part I, must do all electrical work.

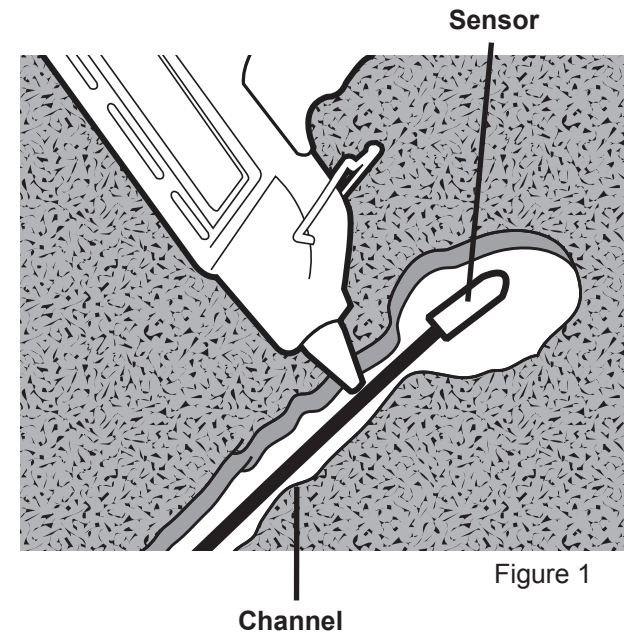

Figure 1

INSTALLATION UNDER CARPET - USA ONLY

BEFORE YOU START

NEVER CUT OR TRIM Environ™ Flex Rolls to fit into a space that is too small.

BE AWARE of the risk of damaging the heating panels with sharp tools, gripper rods, stretchers or seaming irons during installation.

DO NOT drop or carelessly use tools with sharp edges or points on top of the panels.

DO NOT walk on the panels more than is absolutely necessary during installation.

DO NOT drop or place heavy articles on the panels.

DO NOT use folded Environ™ Flex Rolls, and care should be taken not to fold or crease the panels at any time during installation.

DO NOT use Environ™ Flex Rolls on stairs.

DO place Environ™ Flex Rolls directly on top of the carpet cushion (The “carpet cushion” is also known as the “pad”, the “foam” or the “underlay”).

DO place Environ™ Flex Rolls directly under the carpet.

ROLL your Environ™ Flex Rolls up should you wish to install it at some later stage.

Subfloor Preparation

Prepare your subfloor as you normally would for a “normal” carpet installation. Ensure the subfloor is structurally sound and secure with no movement – screw or nail down any loose areas before fitting the underlayment. The subfloor should be clean and dry.

To prevent damage to the panels, special attention should be paid to ensure that no nails, screws, staple, tacks and the like are protruding from the subfloor before the underlayment pad is installed. Beware of automatic staple guns if you use one to secure the cushion / underlayment to the subfloor. A badly installed staple that protrudes from the floor can pierce and destroy the Environ cable and mat.

Nails, screws or staples should not be installed close to the panels and power supply cables.

Permanent fixtures, including built-in furniture and the like, must NEVER be installed on top of the panels. It is important to keep an accurate record of where the panels are installed, to assist you (and a future owner!) to easily locate them should you undertake remodelling work in the room at some future date. Taking a few photographs during the installation process is a good idea.

COMPATIBLE CARPETS

Most modern tufted and woven carpets are compatible with Environ panels. Polypropylene, hessian or jute secondary backings are compatible, but rubber- or foam-backed carpets are not compatible as they trap too much heat.

The carpet must be at least 1/4” thick, but not more than 1” thick.

For the technically minded, the R-value of the carpet should not be greater than 1. Contact carpet manufacture for the r-value rating.

COMPATIBLE CARPET CUSHIONS

Any type of carpet padding can be used as long as it has a density of 6 pounds per cubic foot. Most good quality rebounded polyurethane (rebound) and prime polyurethane are 8 pounds per cubic foot or more.

WARNING: RISK OF CARPET DISCOLORATION

The major factors affecting discoloration of a carpet are:

- the nature of the fibers,
- the type of coloring process and it's application to fibers, yarns, or fabric,
- the color range from pastels to dark colors,
- the temperature level if the heat is trapped under a high level of insulation such as a futon mattress, bean seat or a dog bed,
- the length of time the carpet is exposed to higher temperature.

In our experience, the Environ™ Flex roll, which is powered at approximately 12-watt/sq. feet does not cause carpet discoloration when installed under the conditions of this Installation Manual, specifically the section “Restrictions on Furniture Placement and Precautions”.

However, if excessive insulation is placed for long periods of time over a heated carpet area, some carpets of lighter colors, and lower quality will probably be the first to be subject to discoloration.

INSTALLING THE FLEX ROLLS

Once the carpet cushion has been fitted in the normal manner, remove your Environ Flex rolls from the packaging tube, unroll and cut and turn it completely and place it in the required position on top of the carpet cushion.

When positioning the Flex rolls on the carpet cushion, be aware of the following:

- Keep it at least 1' from any edge of the area to be carpeted, (to prevent the spikes of the power stretcher damaging the panel when the carpet is being fitted);
- Ensure the power supply cables can reach the thermostat point to which they will be connected;
- Wherever possible, run the power supply cables parallel or at right angles to the walls, and avoid high-traffic areas;
- Wherever possible, keep the corner where the power supply cable enters the Flex roll away from high traffic areas;
- NEVER run the power supply cables under or over the Flex rolls;
- Flex rolls can only positioned cable-side down;
- When fitting more than one Flex roll in a room, the Flex rolls MUST NOT OVERLAP, as overheating will result.
- VERIFY the Flex rolls received are the correct voltage.

Smooth out the Flex rolls and adhere the heater to the underlay with adhesive tape as set out below. Any adhesive tape will do.

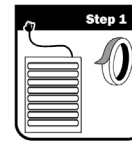

Step 1

Cut away underlay beneath the power cord and corner.

Band tape over this corner of the pad.



Step 2

Stick tape over the heater as shown ensuring it adheres to both the heater and the underlay

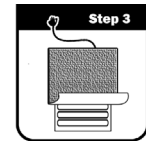

Step 3

Roll the carpet over the heater starting in the direction as shown. The heater will find its own position with the weight of the carpet.

After deciding the route that your power supply cables will take from the Flex roll to the point of supply, cut a 1/4"-wide channel in the carpet cushion along this route and drop the power supply cables into this channel. You may also need to remove a small section of carpet cushion from under the panel at the point where the power supply cord enters the Flex rolls, to prevent an unsightly lump on the carpet surface and excessive wear on that part of the Flex rolls.

Heating Flex rolls shall be installed not closer than 200 mm (8 inches) from heating supply ducts, or any other heating appliances or other source of heat. When installing two or more Environ heating Flex rolls next to each other, the distance between the last wire on the edge of a Flex roll, and the first wire on the edge of the next panel, has to be minimum 3" inches. The heating wires in adjacent panels cannot overlap and we recommend the use of Duct tape to assure that they will not overlap over time.

INSTALLING THE THERMOSTAT

If you are using a thermostat with a floor sensor, tape the sensor to the bottom surface of the Environ heating panel, centered between two heater wires, at least 6" into the heated area. If the carpet and pad are installed over a wood subfloor, the sensor probe can be placed in a quarter-sized area hollowed out of the carpet pad directly under the flex roll. Once the flex rolls have been placed in their final position, hollow out this area at least 6" into the mat, centered between 2 heating wires. Place the sensor in this area and run the sensor wire back to the thermostat in a separate channel in the carpet pad. Place duct tape over this channel and the hollowed-out area and sensor probe. The "heater wires" within the heater are identified as raised parallel lines, either 2" or 3" apart. The sensor wire can cross over the foil heater wires. The sensor probe must use a jacketed wire, this wire needs to be rated 80°C minimum.

Connect the sensor wire to the designated screws on the terminal block on the front of the thermostat power base. The wire must pass outside the electrical box and follow the wall down to the floor. This is a low voltage wire and in most geographical areas it does not need to be housed in a conduit. If you choose to place it in a conduit, use a separate conduit than the conduit used for the 110-volt or 220-volt wires that power the heating element.

Secure the power supply cables (and the thermostat sensor cable, where applicable) in the channel in the carpet cushion with adhesive tape, to prevent them from “riding up” onto the top surface of the carpet cushion and thus causing unsightly lumps or ridges when the carpet is fitted.

Take the cables along the edge of the carpet cushion, between the gripper and the carpet cushion to a point directly below where the thermostat will be fitted (or below the socket outlet if no thermostat is being fitted).

Remove a small section (about 1/4” to 1/2” –wide) of the gripper at a point on the floor below the thermostat and secure the cables to the floor with adhesive tape, hot-melt glue or cable clips, taking care to ensure that the cables are not damaged by the nails of the gripper.

Ensure the positioning of your Environ panel (and the way you have routed the cables on the floor from the panel to the control point) allows sufficient cable length to reach the connection point for the electrician to make the connections.

Place Thermostat Warning Sticker to underside of thermostat’s faceplate. Stickers are supplied with the Environ mats.

Note that the power supply cables of Environ panels are matched to the rated power of the panel. If more than one panel is connected to a thermostat, ensure that the circuit connecting the thermostat to the house power is correctly rated for the total amperage of the combined heaters. For the total amperage of your installation look to your custom design layout or your price quote. Overloaded power circuits may overheat and could start a fire!

NEVER JOIN THE POWER SUPPLY CABLES UNDER THE CARPET. NO SERIAL CONNECTIONS OF ONE PANEL TO ANOTHER PANEL. NO DAISY-CHAINS!

A QUALIFIED ELECTRICIAN MUST CONNECT THE POWER SUPPLY CABLES TO THE THERMOSTAT, AND CONNECT THE THERMOSTAT TO THE SUPPLY.

Before fitting the carpet, test the panels to ensure they are working correctly. A simple test is a visual inspection to make sure there is no visible damage to the heater, and in particular to the cable component in the heater. A simple electrical inspection can be done with an ohms meter to make sure the ohms resistance is what it should be (see page 4). Ohms resistance can vary significantly depending on the ambient temperature and an allowance of +/- 15% from the norm is acceptable. **Verify that the voltage of the panels matches the voltage specified on the plan.**

IMPORTANT POINTS FOR THE CARPET FITTER:

Please ensure that compatible carpet cushion and carpet are being fitted.

Remember that you are laying carpet over a thin electrical heating element. Extra care must be taken when working with sharp tools to avoid damage to the Environ panel, which could cause it to malfunction and fail.

Ensure all cables have been channelled correctly into the carpet cushion to avoid unsightly lumps or an uneven carpet surface.

Do not install nails, screws or staples in direct contact with the ENVIRON heating panels and power supply cable. A staple left protruding can destroy the ENVIRON heater cable.

When making a join (or “seam”) in the carpet, ensure that the seaming iron DOES NOT come into direct contact with the Environ panel, as it will damage the panel. Wherever possible, avoid joins in the carpet over panels. Always use a good quality heat-bond tape, and use an ultra-wide tape when joining heavy wool or similar carpets.

Fit your carpet as normal above the panels, taking special care when working with sharp tools (power stretcher, knee-kicker, knives, scissors etc) in the vicinity of the panels and cables.

RESTRICTIONS ON FURNITURE PLACEMENT AND PRECAUTIONS IN USE:

Always remember that you have a thin electrical appliance installed directly below your carpet!

To prevent any damage to the Environ panel, the carpet cushion, the carpet itself and anything above the carpet (including yourself!), always strictly enforce the following restrictions and precautions:

- **NEVER** pierce the carpet with sharp items such as knives, pins, tacks, staples, needles and the like;
- **NEVER** drive nails or screws through the carpet to secure furniture in position or for any other reason;
- **NEVER** drop heavy articles onto the carpet;
- Area rugs and oriental carpets may be placed on top of the heated carpet; but the total thickness of both carpets (ie the wall to wall carpet plus the rug) must never exceed 1½ inches;
- **Never** use chairs on castors directly on the carpet surface – always use a plastic “carpet protector” that is no more than ½-inch thick and does not have spikes that are long enough to penetrate the backing of the carpet and come into contact with the heater. Most commercial plastic “carpet protector” in the market will be acceptable.
- **Never** place any furniture that has feet with a “footprint” of 1/4–square inch (ie ½” x ½”) or less on the carpet, irrespective of the weight of the furniture.
- **Never** place any item with a “footprint” of 36-square inches (ie 6” x 6”) or more on the carpet, if that item is thicker than 1” (for example, do not leave a mattress, bean bag or dog bed on the carpet).
- Furniture that has feet with a footprint between ¼-square inch and 36-square inches must not exert a force greater than 100 pounds per square inch (“psi”) on the carpet surface. The psi of any piece of furniture may be determined by dividing its total weight (in pounds) by the total surface area of the parts in contact with the carpet (in square inches), eg a 150-pound sofa on which two 250-pound adults are sitting has a total weight of 650 pounds. If it has 4 feet, each 2” x 2”, the total surface contact area is 4 x (2” x 2”) = 16-square inches. 650 pounds divided by 16-sq.in. = 40 pounds per square inch.
- Any bulky item of furniture on short legs (e.g. a sofa or a bed) must have a minimum of 2-inches clearance between the top surface of the carpet and the underside of the furniture to allow free movement of air through that space. Do not allow bedclothes or drapes to restrict the **airflow under a bed!**
- **Specific items of furniture that should never be allowed onto the carpet surface:-**
 - **Pianos**
 - **Stands for hi-fi speakers that have sharp points as feet**
 - **Bookcases**
 - **Closed-bottom furniture**