



## Instructions & Operation Manual for **WarmlyYours Mirror Defoggers**



Congratulations on the purchase of your Mirror Defogger. This system can be easily installed behind any mirror to keep it steam free and crystal clear whenever you use the bathroom. Simply turn on the lights and the Mirror Defogger will provide a clear, steam free section of mirror for you to begin your day.

## **SAFETY INFORMATION**



- All wiring must be in accordance with the National Electrical Code (NEC) and should be performed by a licensed professional who is certified to do electrical wiring.
- Make sure that the electrical circuit breaker is shut off at the main panel before wiring your Mirror Defogger.
- Never place your 120 volt Mirror Defogger inside a shower, sauna, or steam room.
- Check the Mirror Defogger for damage before installation. Creases, tears or other obvious damage may cause the unit to malfunction.
- Do not overlap Mirror Defoggers when using more than one on a mirror.
- Never cut or resize the Mirror Defogger.
- Use caution with all electrical appliances.
- Install in compliance with these instructions.

## **CLEANING INFORMATION**

Use ordinary window cleaner to clean mirrors which have the Mirror Defogger installed, just as you would any other mirror.

# INSTALLATION INSTRUCTIONS

This appliance must be installed in accordance with the instructions in this manual and the NEC guidelines relating to bathroom electrical fixtures. The Mirror Defogger must be on a GFCI protected circuit and wired by a professional certified to do electrical wiring.

## Determine Location of Mirror Defogger

### Step 1

Choose a location for your Mirror Defogger so that everyone in your home can enjoy it.

- For the larger rectangular and oval shaped Mirror Defoggers, place the system so that the top edge is 6'6" above the floor. Refer to **Diagram A**.
- For smaller rectangular and circular shaped Mirror Defoggers, center them over the vanity and in the center of the mirror. Refer to **Diagram B**.

### Step 2

Mark the wall with the location where you will be installing the Mirror Defogger. Mark the location where the lead wires leave the Mirror Defogger.

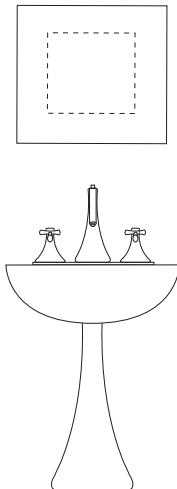

Diagram A

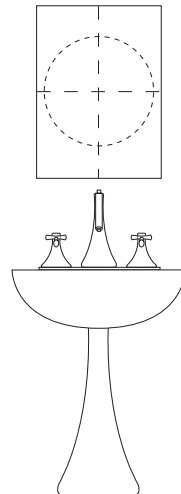
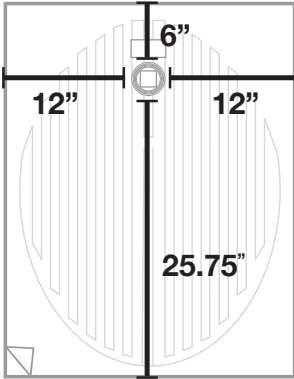

Diagram B

# INSTALLATION INSTRUCTIONS

## Step 2 - Cont.

Location where the lead wire leaves the Mirror Defoggers.



**FFM-2432OV**

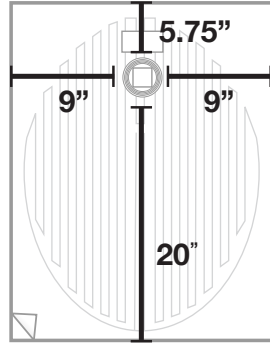

**FFM-1826OV**

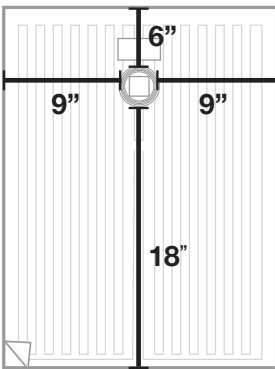

**FFM-1824**

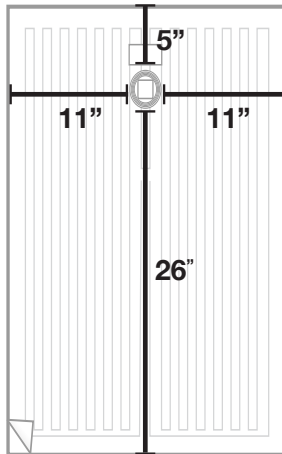

**FFM-2432**

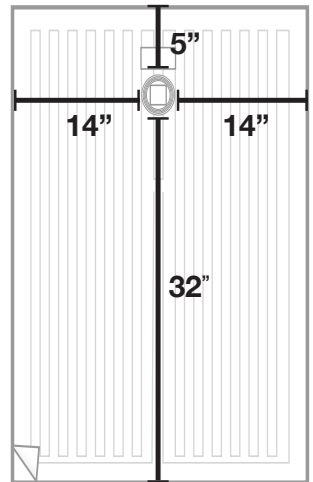

**FFM-3040**

# INSTALLATION INSTRUCTIONS

## Step 2 - Cont.

Location where the lead wire leaves the Mirror Defoggers.

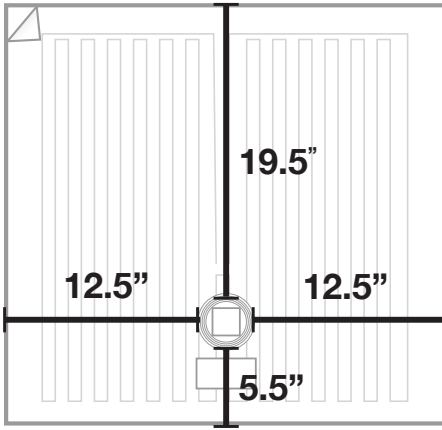

**FFM-25R**

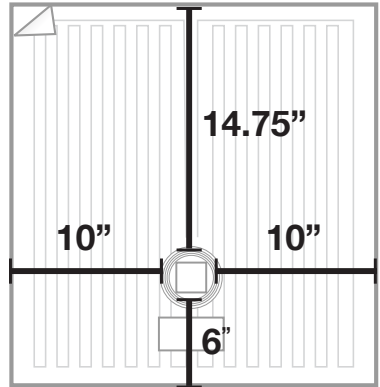

**FFM-20R**

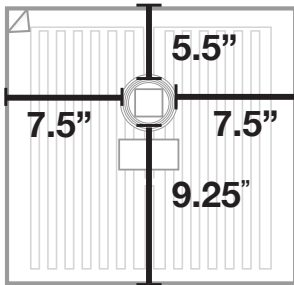

**FFM-15R**

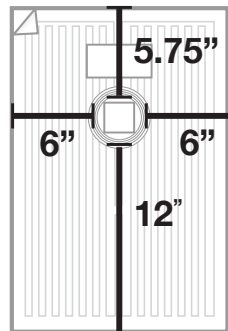

**FFM-1218**

## Prepare Electrical Rough-In and Wiring

### Step 3

Using the location you determined in Step 2, install a 2" x 3" remodeler's electrical junction box inline with the Mirror Defogger's lead wires. Refer to **Diagram C**.

Note: The location where the wires leave must be entirely within the area of the new electrical junction box.

### Step 4

Run Romex cable from a nearby junction box to the new box. Typically the most convenient junction box is the one that supplies power to the lighting above the mirror. This will enable the system to turn on automatically whenever the bathroom lights are turned on.

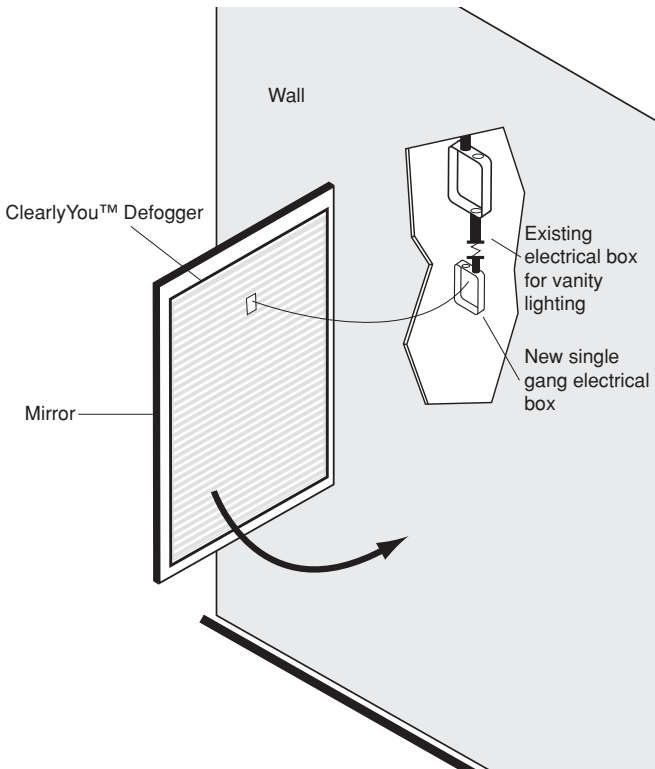

Diagram C

## Attach Mirror Defogger to the back of the Mirror

### Step 5

Place the element on the mirror so that it will line up with the markings on the wall.

### Step 6

Dry fit the Mirror Defogger on the mirror, and line up the lead wires with electrical box. Do not remove paper backing yet. Draw an outline of the Mirror Defogger on the mirror.

### Step 7

Peel back 2” of backing from the Mirror Defogger and line it up with outline drawn in Step 6. Adhere backing to the top of the Mirror Defogger and slowly remove the rest of the backing, sticking the Mirror Defogger to the back of the mirror as you progress, to smooth out any air bubbles that may appear. Refer to **Diagram D**.

Note: If gluing mirror to wall, apply adhesive to the mirror backing, not covered with the Mirror Defogger.

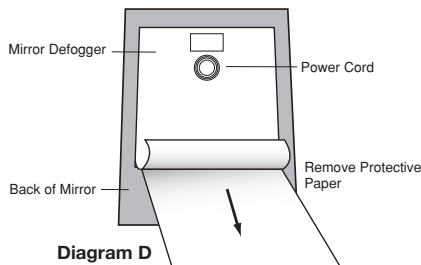

## Electrical Wiring

### Step 8

With the assistance of another person, position the mirror so the leads can be connected to the Romex cable as referred to in Step 4. Refer to **Diagram E** for specific wiring instructions.



## Electrical Wiring Step 8 - continued

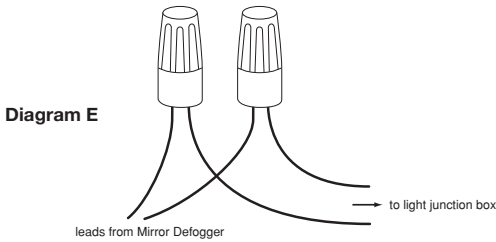

### Step 9

Push the excess wire into the junction box.

### Step 10

Wire the Romex cable to the junction box that houses the electrical wiring for the existing lighting.

## Install Mirror

### Step 11

Install mirror in line with the mirror manufacturer's instructions.

## OPERATION

By wiring the Mirror Defogger to the lighting above the vanity, the Mirror Defogger will automatically turn on whenever you turn on your vanity lighting. The Mirror Defogger will begin to defog within 5 minutes of operation.

## SPECIFICATIONS

MIRROR DEFOGGERS - 120 VOLT				
ITEM #	SHAPE	DIMENSIONS	WATTS	AMPS
FFM-1218	Rectangle	12"W x 18"L	57	0.5
FFM-1824	Rectangle	18"W x 24"L	96	0.8
FFM-2432	Rectangle	24"W x 32"L	108	0.9
FFM-3040	Rectangle	30"W x 40"L	150	1.3
FFM-15R	Circle	15"W x 15"L	20	0.2
FFM-20R	Circle	20"W x 20"L	41	0.4
FFM-25R	Circle	25"W x 25"L	65	0.6
FFM-1826OV	Oval	18"W x 26"L	76	0.7
FFM-2432OV	Oval	24"W x 32"L	87	0.8

## Installing Mirror (cont.)

### CAUTION:

**Electric heated mirror may crack under the following conditions:**

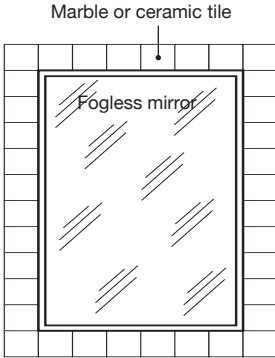

1. If there is no gap between the mirror and hard substances. If there is tile or marble around the perimeter of the heated mirror, the mirror may crack during heating because there is not enough room to allow for the expansion of the mirror. A 2mm gap around the perimeter of the mirror is required to allow for this expansion.

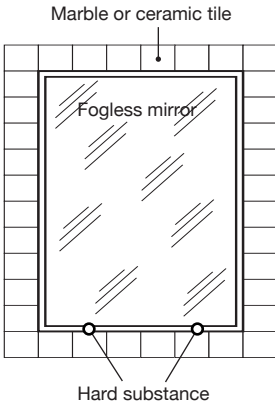

2. If a mirror is held in place by a nail or other rigid mounting materials, ensure that there is room for expansion around the other 3 edges. The mirror may crack if trapped between the mounts and other hard objects.

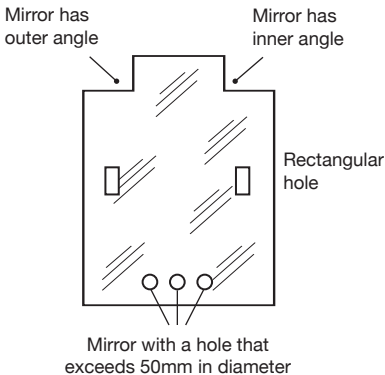

3. The following are 3 examples of mirror cutting that may cause the mirror to crack

- a rectangular hole for a switch, outlet, or other appliance.
- a hole exceeding a diameter of 2" (50mm). Common for plumbing.
- inner angles cut into the mirror.

## Safety Ratings



The Mirror Defogger is UL listed under standard 499. The main electrical line feeding the Mirror Defogger must incorporate a GFCI for North America. For the file number, please contact WarmlyYours.

## WarmlyYours Warranty Information

WarmlyYours.com Inc. warrants the WarmlyYours Mirror Defogger (“the Product”) to be free from defects in materials and workmanship for 1 year from the date of sale, provided that the Product is installed in accordance with the accompanying Instructions and Operation Manual, any special written design or installation guidelines provided by WarmlyYours.com Inc., the National Electrical Code (NEC), and all applicable local building and electrical codes.

Any suspected defect must be reported by registered letter immediately upon discovery. The determination of the existence of such a defect will be made by WarmlyYours.com Inc., or its authorized representative only. Upon notification of an actual or possible problem, WarmlyYours.com Inc. will issue an Authorization to Proceed under the terms of the Limited Warranty.

This warranty is null and void if the Product is improperly used, operated or installed, or if the owner or his representative attempts to repair the Product without receiving authorization.

Under this Limited Warranty, WarmlyYours.com Inc. will provide the following remedy:

If the product is determined to be defective in materials and workmanship, and has not been damaged as a result of misuse, misapplication or improper installation, WarmlyYours.com Inc. will refund the original purchase price or replace the Product.

WARMLYYOURS.COM INC. DISCLAIMS ANY WARRANTY NOT PROVIDED HEREIN, INCLUDING ANY IMPLIED WARRANTY OF MERCHANTABILITY OR IMPLIED WARRANTY OF FITNESS FOR A PARTICULAR PURPOSE. WARMLYYOURS.COM INC. FURTHER DISCLAIMS ANY RESPONSIBILITY FOR SPECIAL, INDIRECT, SECONDARY, INCIDENTAL, OR CONSEQUENTIAL DAMAGES ARISING FROM OWNERSHIP OR USE OF THIS PRODUCT, INCLUDING INCONVENIENCE OR LOSS OF USE. THERE ARE NO WARRANTIES WHICH EXTEND BEYOND THE FACE OF THE DOCUMENT. NO AGENT OR REPRESENTATIVE OF WARMLYYOURS.COM INC. HAS ANY AUTHORITY TO EXTEND OR MODIFY THIS WARRANTY UNLESS SUCH EXTENSION OR MODIFICATION IS IN WRITING BY A CORPORATE OFFICER.

Please fill in warranty card information at [www.warmlyyours.com/warranty/md](http://www.warmlyyours.com/warranty/md) or to register via phone, please call (800) 875-5285 to speak to one of our customer service representatives.