

# EXTERMINATOR – model: LED20

## LEDme® Track Luminaire

# WAC LIGHTING

Responsible Lighting®

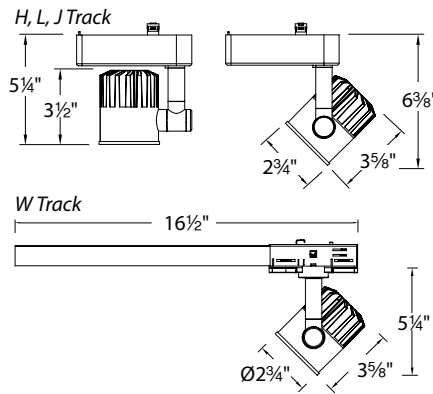

Fixture Type:

Catalog Number:

Project:

Location:

### PRODUCT DESCRIPTION

LEDme® Exterminator offers superior light output in a small, unobtrusive design. The high output LEDs out perform a 20W metal halide fixture at the size of a typical MR16 luminaire. Developed for upscale residential and commercial environments.

### FEATURES

- Free of projected heat and UV and IR radiation
- Twist lock aiming mechanism
- Available in two interchangeable optics
- Alternate beam angles may be ordered separately
- Replaceable LED modules
- Accommodates 1 lens or accessory
- 355° horizontal and 180° vertical aiming
- Lockable vertical aiming for precise adjustments
- 60,000 hour rated life
- 5 year WAC Lighting product warranty

### SPECIFICATIONS

**Construction:** Die-cast aluminum with removable lens cap for easy change of lenses or accessories

**Driver:** Input voltage: 120VAC or 277VAC 50/60Hz.

**Light Source:** High output LED.

**Dimming:** Dimmable with electronic low voltage (ELV) dimmer (120V only).

**Finish:** Black (BK), Platinum (PT - W Track Only) and White (WT) powder coat paint.

**Standards:** ETL Listed.

### FIXTURE PERFORMANCE

Model #	Beam	Voltage	Color Temp	Power	Lumens	Efficacy	CBCP	CRI
<b>LED20S-927</b>	20°	120V	2700K	23W	984	43 Lm/W	4682	90
<b>LED20F-927</b>	40°				984	43 Lm/W	2069	
<b>LED20S-27</b>	20°	120V	2700K	23W	1230	53 Lm/W	5853	85
<b>LED20F-27</b>	40°				1230	53 Lm/W	2586	
<b>LED20S-930</b>	20°	120V	3000K	23W	1103	48 Lm/W	5110	90
<b>LED20F-930</b>	40°				1050	46 Lm/W	2207	
<b>LED20S-30</b>	20°	120V	3000K	23W	1345	58 Lm/W	6232	85
<b>LED20F-30</b>	40°				1280	56 Lm/W	2692	
<b>LED20S-35</b>	20°	120V	3500K	23W	1400	61 Lm/W	6620	85
<b>LED20F-35</b>	40°				1385	60 Lm/W	2897	
<b>LED20S-40</b>	20°	120V	4000K	23W	1450	63 Lm/W	6772	85
<b>LED20F-40</b>	40°				1390	60 Lm/W	2928	
<b>LED20S-927</b>	20°	277V	2700K	23W	984	43 Lm/W	4682	90
<b>LED20F-927</b>	40°				984	43 Lm/W	2069	
<b>LED20S-27</b>	20°	277V	2700K	23W	1230	54 Lm/W	5853	85
<b>LED20F-27</b>	40°				1230	54 Lm/W	2586	
<b>LED20S-30</b>	20°	277V	3000K	23W	1103	48 Lm/W	5110	90
<b>LED20F-30</b>	40°				1050	46 Lm/W	2207	
<b>LED20S-30</b>	20°	277V	3000K	23W	1345	59 Lm/W	6620	85
<b>LED20F-30</b>	40°				1280	56 Lm/W	2692	
<b>LED20S-35</b>	20°	277V	3500K	23W	1400	61 Lm/W	6620	85
<b>LED20F-35</b>	40°				1385	60 Lm/W	2897	
<b>LED20S-40</b>	20°	277V	4000K	23W	1450	63 Lm/W	6772	85
<b>LED20F-40</b>	40°				1390	59.5 Lm/W	2928	

### ORDER NUMBER

Track Type	System	Model	Beam	Color Temp	Finish	
Single-Circuit H, L, J/J2 Track	L H J	120V	LED20	S 20°	927 2700K (90 CRI)	BK Black
				F 40°	27 2700K	WT White
				S 20°	930 3000K (90 CRI)	BK Black
				F 40°	30 3000K	PT Platinum
Two-Circuit W Track	WTK WHK	120V 277V	LED20	S 20°	35 3500K	WT White
				F 40°	40 4000K	

### REPLACEABLE LED MODULES

2700K (90 CRI)	<b>BXRC-27G1000</b>
2700K	<b>BXRC-27E1000</b>
3000K (90 CRI)	<b>BXRC-30G1000</b>
3000K	<b>BXRC-30E1000</b>
3500K	<b>BXRC-35E1000</b>
4000K	<b>BXRC-40E1000</b>

### INTERCHANGABLE OPTICS

Model	Beam
<b>RF-S</b>	20°
<b>RF-F</b>	40°

### LENSES

Color Lens	<b>AMB</b> Amber	Frosted Lens <b>LENS-16-FR</b> Spread Lens <b>LENS-16-SPR</b> Beam Elongating <b>LENS-16-BEL</b>
	<b>BLU</b> Blue	
	<b>GRN</b> Green	
	<b>RED</b> Red	
	<b>YEL</b> Yellow	

- **LED20**  -  -

Example: L-LED20S-30-WT

### WAC Lighting

www.waclighting.com

Phone (800) 526.2588 • Fax (800) 526.2585

### Headquarters/Eastern Distribution Center

44 Harbor Park Drive • Port Washington, NY 11050

Phone (516) 515.5000 • Fax (516) 515.5050

### Western Distribution Center

1750 Archibald Avenue • Ontario, CA 91760

Phone (800) 526.2588 • Fax (800) 526.2585

# EXTERMINATOR – model: LED20

## Photometrics

# WAC LIGHTING

Responsible Lighting®

### FIXTURE PERFORMANCE – 2700K

▲ 0° Aiming Angle (ceiling to floor)

**LED20S-27**  
20° beam

Distance	FC	L	W
6 ft	163	2.1	2.1
9 ft	72	3.2	3.2
12 ft	41	4.2	4.2
15 ft	26	5.3	5.3

**LED20F-27**  
40° beam

Distance	FC	L	W
6 ft	72	4.4	4.4
9 ft	32	6.6	6.6
12 ft	18	8.7	8.7
15 ft	11	10.9	10.9

◀ 45° Aiming Angle (ceiling to wall)

**LED20S-27**  
20° beam

Distance	FC	L	W
6 ft	57	4.4	3.0
9 ft	26	6.6	4.5
12 ft	14	8.7	6.0
15 ft	9	10.9	7.5

**LED20F-27**  
40° beam

Distance	FC	L	W
6 ft	25	10.1	6.2
9 ft	11	15.1	9.3
12 ft	6	20.1	12.4
15 ft	4	25.2	15.4

### LED20S-27

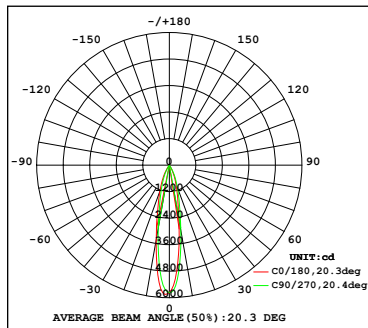

### LED20F-27

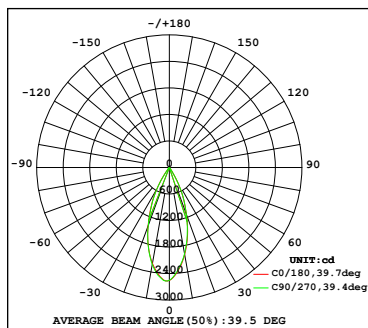

### FIXTURE PERFORMANCE – 3000K

▲ 0° Aiming Angle (ceiling to floor)

**LED20S-30**  
20° beam

Distance	FC	L	W
6 ft	173	2.1	2.1
9 ft	77	3.2	3.2
12 ft	43	4.2	4.2
15 ft	28	5.3	5.3

**LED20F-30**  
40° beam

Distance	FC	L	W
6 ft	75	4.4	4.4
9 ft	33	6.6	6.6
12 ft	19	8.7	8.7
15 ft	12	10.9	10.9

◀ 45° Aiming Angle (ceiling to wall)

**LED20S-30**  
20° beam

Distance	FC	L	W
6 ft	61	4.4	3.0
9 ft	27	6.6	4.5
12 ft	15	8.7	6.0
15 ft	10	10.9	7.5

**LED20F-30**  
40° beam

Distance	FC	L	W
6 ft	26	10.1	6.2
9 ft	12	15.1	9.3
12 ft	7	20.1	12.4
15 ft	4	25.2	15.4

### LED20S-30

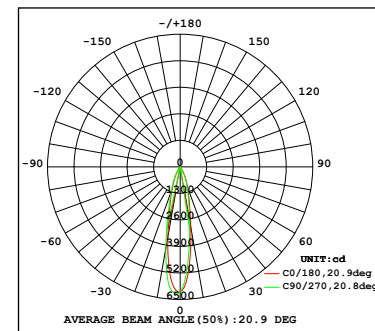

### LED20F-30

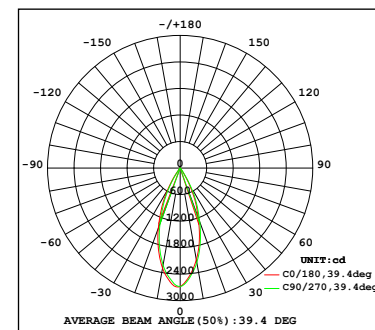

**FC**– Initial footcandle level at the center of the beam

**L**– Beam length at the point the candlepower drops off to 50% of maximum\*

**W**– Beam width at the point the candlepower drops off to 50% of maximum\*

\*Measured in feet

### WAC Lighting

www.waclighting.com

Phone (800) 526.2588 • Fax (800) 526.2585

### Headquarters/Eastern Distribution Center

44 Harbor Park Drive • Port Washington, NY 11050

Phone (516) 515.5000 • Fax (516) 515.5050

### Western Distribution Center

1750 Archibald Avenue • Ontario, CA 91760

Phone (800) 526.2588 • Fax (800) 526.2585

# EXTERMINATOR – model: LED20

## Photometrics

### FIXTURE PERFORMANCE – 3500K

▲ 0° Aiming Angle (ceiling to floor)

**LED20S-35**  
20° beam

Distance	FC	L	W
6 ft	184	2.1	2.1
9 ft	82	3.2	3.2
12 ft	46	4.2	4.2
15 ft	29	5.3	5.3

**LED20F-35**  
40° beam

Distance	FC	L	W
6 ft	80	4.4	4.4
9 ft	36	6.6	6.6
12 ft	20	8.7	8.7
15 ft	13	10.9	10.9

◀ 45° Aiming Angle (ceiling to wall)

**LED20S-35**  
20° beam

Distance	FC	L	W
6 ft	65	4.4	3.0
9 ft	29	6.6	4.5
12 ft	16	8.7	6.0
15 ft	10	10.9	7.5

**LED20F-35**  
40° beam

Distance	FC	L	W
6 ft	28	10.1	6.2
9 ft	13	15.1	9.3
12 ft	7	20.1	12.4
15 ft	5	25.2	15.4

### LED20S-35

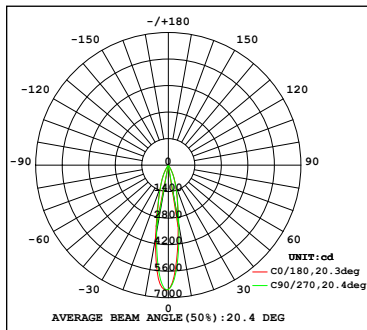

### LED20F-35

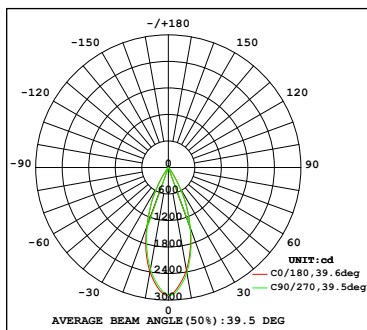

### FIXTURE PERFORMANCE – 4000K

▲ 0° Aiming Angle (ceiling to floor)

**LED20S-40**  
20° beam

Distance	FC	L	W
6 ft	188	2.1	2.1
9 ft	84	3.2	3.2
12 ft	47	4.2	4.2
15 ft	30	5.3	5.3

**LED20F-40**  
40° beam

Distance	FC	L	W
6 ft	81	4.4	4.4
9 ft	36	6.6	6.6
12 ft	20	8.7	8.7
15 ft	13	10.9	10.9

◀ 45° Aiming Angle (ceiling to wall)

**LED20S-40**  
20° beam

Distance	FC	L	W
6 ft	67	4.4	3.0
9 ft	30	6.6	4.5
12 ft	17	8.7	6.0
15 ft	11	10.9	7.5

**LED20F-40**  
40° beam

Distance	FC	L	W
6 ft	29	10.1	6.2
9 ft	13	15.1	9.3
12 ft	7	20.1	12.4
15 ft	5	25.2	15.4

### LED20S-40

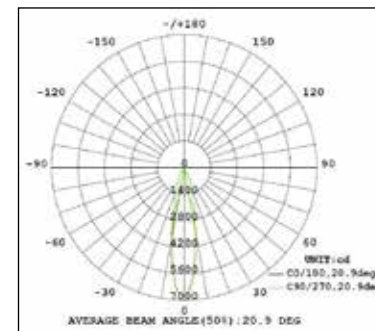

### LED20F-40

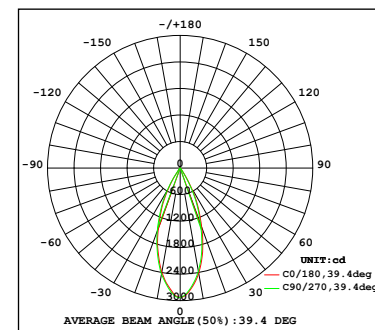

**FC**– Initial footcandle level at the center of the beam

**L**– Beam length at the point the candlepower drops off to 50% of maximum\*

**W**– Beam width at the point the candlepower drops off to 50% of maximum\*

\*Measured in feet

### WAC Lighting

www.waclighting.com

Phone (800) 526.2588 • Fax (800) 526.2585

### Headquarters/Eastern Distribution Center

44 Harbor Park Drive • Port Washington, NY 11050

Phone (516) 515.5000 • Fax (516) 515.5050

### Western Distribution Center

1750 Archibald Avenue • Ontario, CA 91760

Phone (800) 526.2588 • Fax (800) 526.2585