

# INSTALLATION INSTRUCTION

## 133 –Outdoor Wall Sconce

WS-W13348,WS-W13360

# dweLED

**CAUTION:** To prevent electrical shock, ensure electricity has been turned off at the circuit breaker before beginning.

- Read all instructions before installing.
- System is intended for installation by a licensed electrician in accordance with the National Electrical Code (NEC) and local regulations.
- When handling the fixture, do not apply pressure to the LEDs. Hold the fixture by the base only.
- Retain installation instructions for future maintenance reference.

**WARNING:** All parts must be used as indicated in these instructions. This product is designed for use only with the supplied parts and/or accessories designated for use by dweLED. Substitution of parts or accessories not designated for use with this product by dweLED could result in personal injury or property damage, and will void the warranty. Contact an authorized dealer or the manufacturer if any parts are damaged or missing.

**MAINTENANCE NOTE:** Coastal conditions may cause mineral and residue build-up on the fixture. We recommend that customers in coastal areas clean all external surfaces of the fixture once every two weeks with a wet cloth.

**MISE EN GARDE:** Pour éviter tout choc électrique, assurez-vous que le disjoncteur soit mis hors tension avant de commencer.

- Lisez toutes les instructions avant l'installation.
- Le système doit être installé par un électricien licencié conformément au code national de l'électricité (NEC), et également aux règlements locaux.
- Lors de la manipulation du luminaire, n'appuyez pas sur les LED. Tenez-le uniquement par la base.

**ATTENTION:** Toutes les pièces doivent être utilisées comme indiqué dans ces instructions. Ce produit est conçu pour être utilisé seulement avec les pièces et/ou accessoires fournis pour être utilisés avec les produits dweLED. Remplacer des pièces ou accessoires non conçus pour ce produit dweLED pourrait causer des dommages corporels ou matériels et pourrait également causer l'annulation de la garantie. Veuillez contacter un revendeur autorisé ou le fabricant si des pièces manquent ou sont endommagées.

**NOTE D'ENTRETIEN:** Les conditions côtières peut causer une accumulation de minéraux et de résidu sur le luminaire. Nous recommandons aux clients qui résident dans les zones côtières de nettoyer toutes les surfaces externes du luminaire une fois toutes les deux semaines avec un chiffon humide.

### HARDWARE

**A**



Wire Connector  
Qty: 3pcs+1 Extra

**B**



Mounting Screw  
Qty: 1 Extra

**C**



Silicone gasket  
Qty: 1 Extra

**D**



Plastic Anchor  
Qty: 4pcs+1Extra

**E**



Wood Screw  
Qty: 4pcs+1Extra

**F**



Wire Connector  
Qty: 1Extra

### Mounting Plate Dimensions

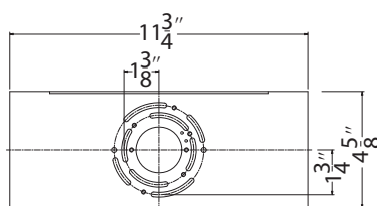

WS-W13348

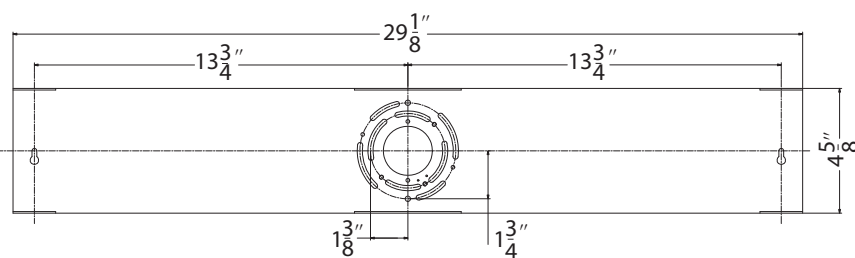

WS-W13360

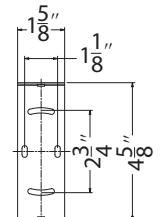

dweLED.com  
Phone (800) 526.2588  
Fax (800) 526.2585

Headquarters/Eastern Distribution Center  
44 Harbor Park Drive  
Port Washington, NY 11050

Central Distribution Center  
1600 Distribution Ct  
Lithia Springs, GA 30122

Western Distribution Center  
1750 Archibald Avenue  
Ontario, CA 91760



INSTALLATION INSTRUCTION  
**133 –Outdoor Wall Sconce**  
 WS-W13348,WS-W13360



Fig.1

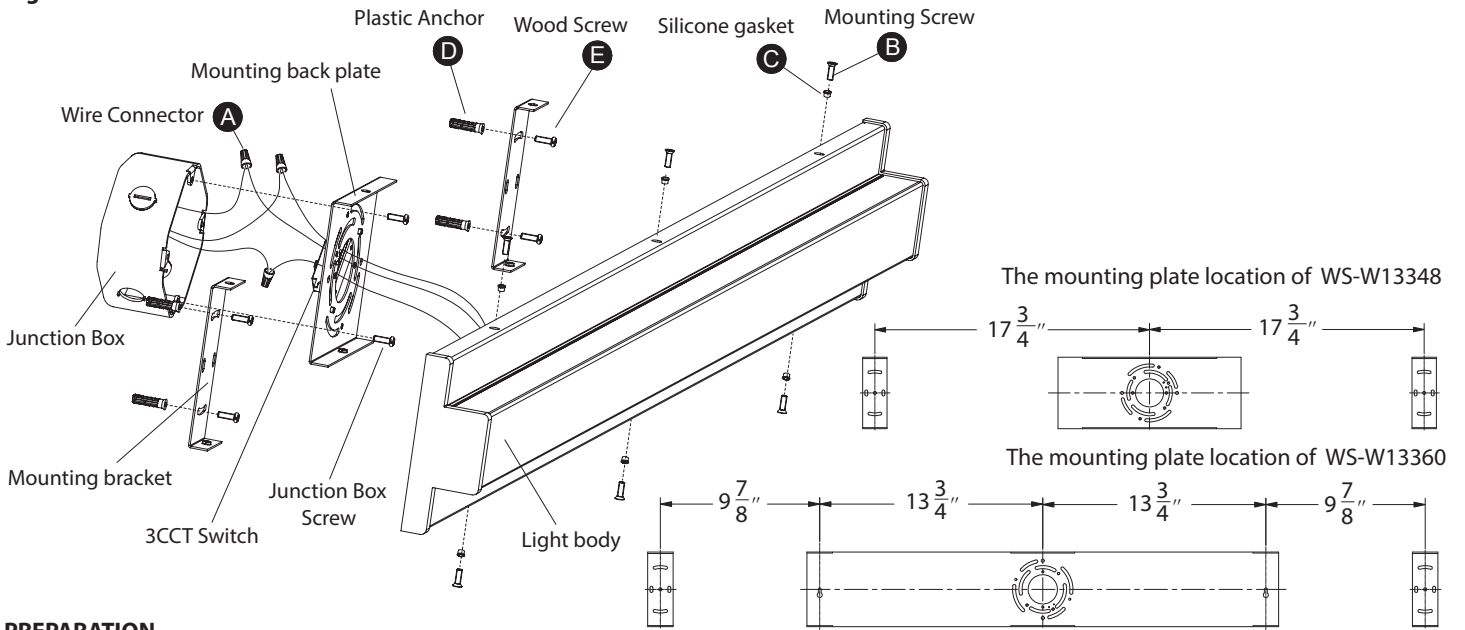

**PREPARATION**

1. Shut off the power at the circuit breaker and remove existing fixture, including the crossbar.
2. Carefully unpack your new fixture and lay out all the parts on a clear area. Be careful not to lose any small parts necessary for installation.

**MOUNTING THE FIXTURE (Fig. 1)**

3. Remove the mounting screw (B) and silicone Gasket (C) from the light body.
4. Set color temperature at this stage. The fixture can switch between three color temperatures (3000k, 3500k, 4000k), which can be adjusted to your preference using the switch (Fig. 4), mounted on the mounting back plate.
5. Refer to the measurements provided in Fig. 1 labeled mounting plate location so that the drill holes are aligned with the mounting holes in the mounting plate, insert the plastic anchor (D).
6. Secure the mounting back plate to the junction box using standard junction box screws that comes with the junction box. Fasten it to the wall using wood screw (E) onto the plastic anchor.

Note: (i)using any other non-original- manufacturer Provided junction box screw may result in safety issue;  
 (ii) The side of the mounting plate marked "GND" must face out.

**CONNECTING THE WIRES (Fig. 2)**

7. Connect the fixture's wires to 3CCT switch wires as shown in Fig. 5. Brown to brown, blue to blue, and black to black. Ensure wire connectors are secure. Connect the fixture's wires to junction box wires as shown in Fig. 2, making sure that all wire connectors (A) are secured. If your outlet box has a green or bare copper ground wire, connect the fixture's ground wire to it. Otherwise, connect the fixture's ground wire directly to the back plate using screw provided. After wires are connected, tuck them carefully inside the junction box.

**COMPLETING THE INSTALLATION**

8. Secure the fixture to the mounting back plate using the mounting screw (B) and silicone gasket (C).
9. To prevent moisture from entering the outlet box and causing a short, use clear caulking (i.e. indoor/outdoor silicone sealant) to outline the outside of fixture back plate where it meets the wall(Fig.3).

Fig.4 Switch

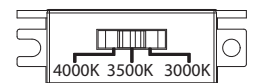

Fig.2 Wiring

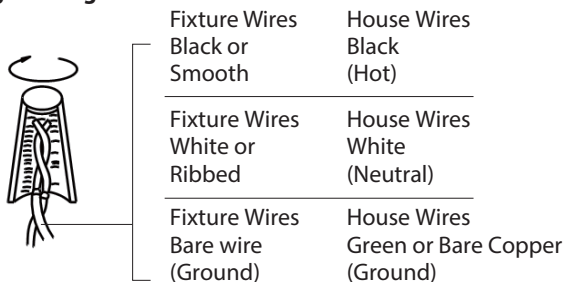

Fig.3 Sealing

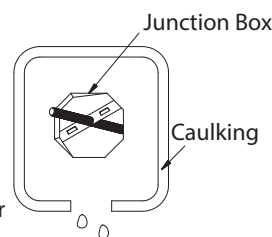
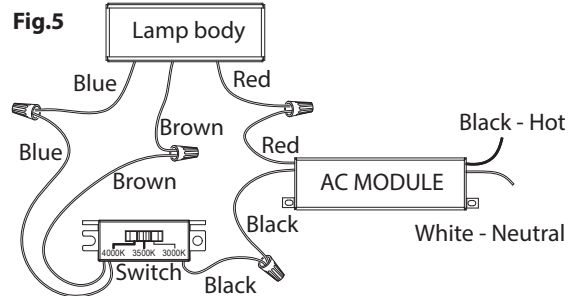

Fig.5



dweLED.com  
 Phone (800) 526.2588  
 Fax (800) 526.2585

Headquarters/Eastern Distribution Center  
 44 Harbor Park Drive  
 Port Washington, NY 11050

Central Distribution Center  
 1600 Distribution Ct  
 Lithia Springs, GA 30122

Western Distribution Center  
 1750 Archibald Avenue  
 Ontario, CA 91760

